

# INDUSTRIAL POWER SEMICONDUCTOR GUIDE: SHORT FORM

Inverter SCRs | Phase Control SCRs | Diodes | Heatsinks | Assemblies

## Diodes

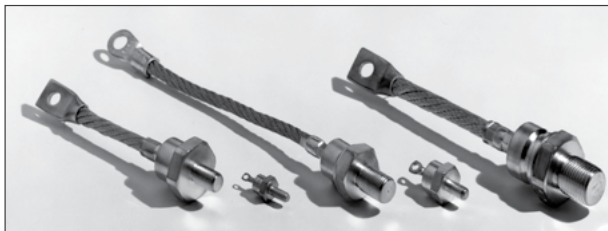

## Inverter Stacks

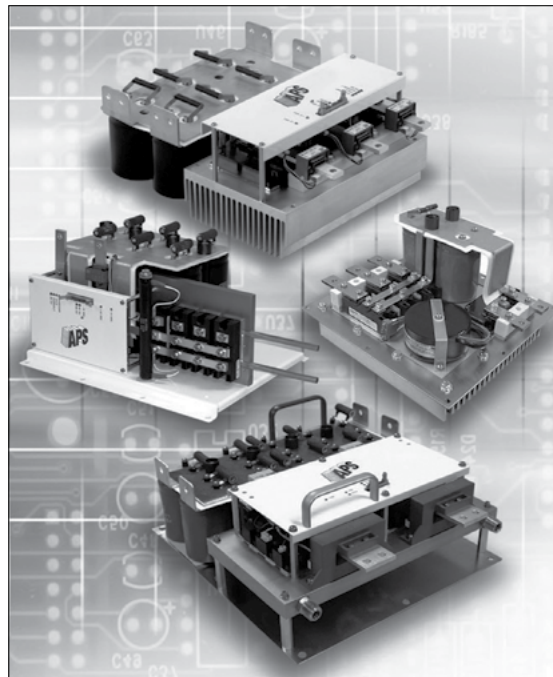

## SCRs

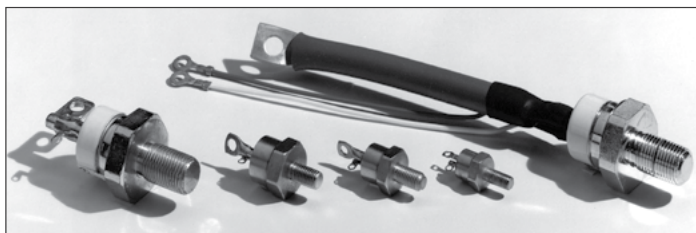

## Converters

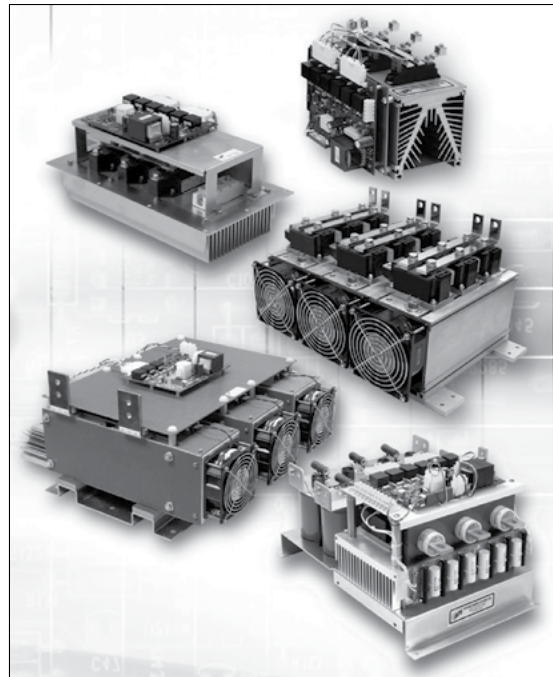

## Power Modules

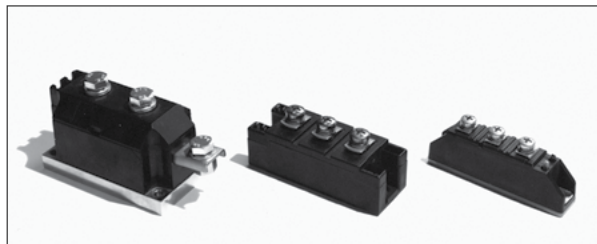

## Driver Boards

Drivers for IGBTs and MOSFETs

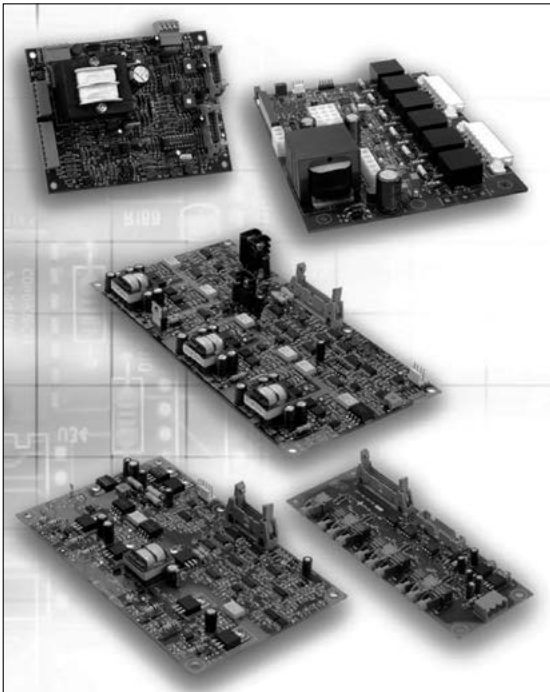

SCR GATE FIRING BOARDS



AUXILIARY CONTROL BOARDS

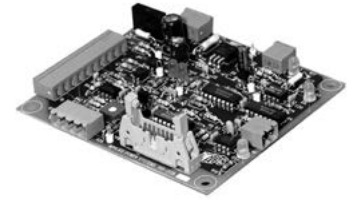

SNUBBER BOARDS



Power Semiconductor Assemblies, Heatsink Kits and Clamps

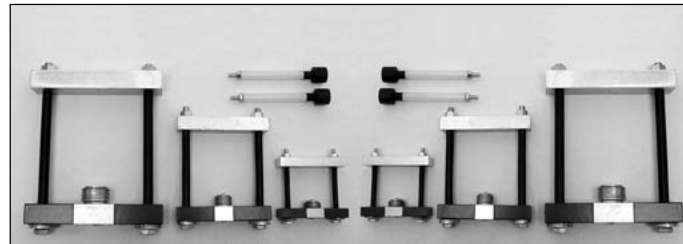
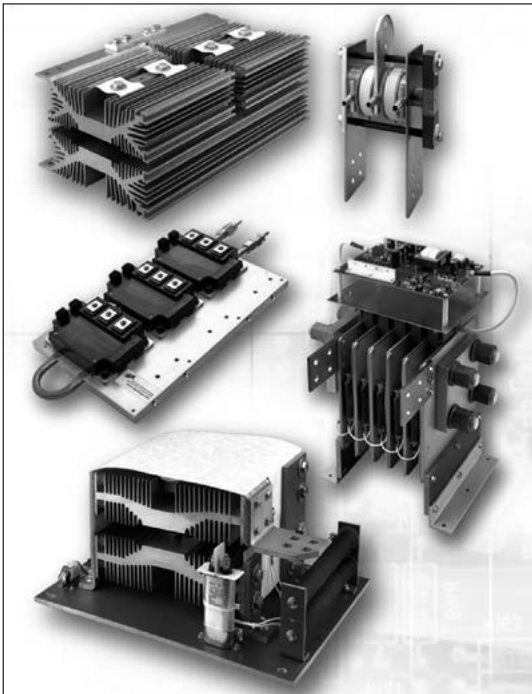

## Capacitors

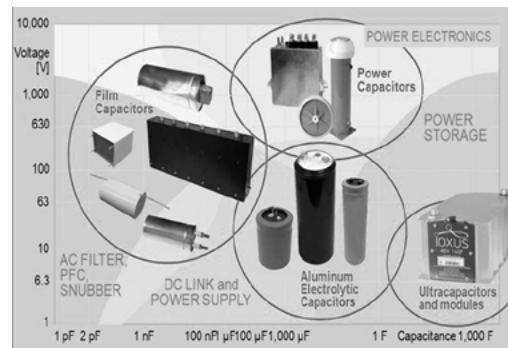

## CAPACITORS, RESISTORS & OTHER PASSIVES

Cornel Dubilier / FT Cap / High Energy Corp. / IOXUS / Jennings / Morgan / National Electronics / Ohmite / Tecate Group / Vishay

## ELECTRON TUBES & COMPONENTS

Amperex / CPI / Excelitas / GE / National Electronics / NJRC / Thales

Richardson Electronics' Power & Microwave Technologies group also carries parts for industrial microwave and CO<sub>2</sub>/fiber lasers. Visit [rellpower.com](http://rellpower.com) and [rellaser.com](http://rellaser.com) to learn more.

## POWER SEMICONDUCTORS / SYSTEMS

Applied Power Systems, Inc. / Bonitron / CSR Times Electric / Global Power / National Electronics / StarPower / Transphorm / Wolfspeed