



STANDARD

EXTRUSION

PROFILES

 **Cooling Source**[®]

No.	Material Number	Specifications	Page #
1	CS500-100-BA-00	23.00*9.20*FREE±0.2	06
2	CS500-101-BA-00	41.95*10.0*FREE±0.2	06
3	CS500-102-BA-00	20.0*9.14*FREE±0.2	06
4	CS500-103-BA-00	23.0*9.2*FREE±0.2	06
5	CS500-104-BA-00	36.83*22.5*FREE±0.2	06
6	CS500-105-BA-00	40.0*18.0*FREE±0.2	06
7	CS500-106-BA-00	36.8*10.44*FREE±0.2	06
8	CS500-107-BA-00	26.0*7.0*FREE±0.2	06
9	CS500-108-BA-00	50.74*10.0*FREE±0.2	07
10	CS500-109-BA-00	50.0*18.75*FREE±0.2	07
11	CS500-110-BA-00	50.8*7.9*FREE±0.2	07
12	CS500-111-BA-00	53.34*10.4*FREE±0.2	07
13	CS500-112-BA-00	35.0*6.6*FREE±0.2	07
14	CS500-113-BA-00	54.0*26.0*FREE±0.2	07
15	CS500-114-BA-00	55.0*23.0*FREE±0.2	07
16	CS500-115-BA-00	92.0*6.45*FREE±0.2	07
17	CS500-116-BA-00	92.0*6.50*FREE±0.2	08
18	CS500-117-BA-00	162.0*29.70*FREE±0.2	08
19	CS500-118-BA-00	65.0*10.5*FREE±0.2	08
20	CS500-119-BA-00	74.93*9.0*FREE±0.2	08
21	CS500-120-BA-00	50.8*8.4*FREE±0.2	08
22	CS500-121-BA-00	62.20*10.0*FREE±0.2	08
23	CS500-122-BA-00	170.0*20.5*FREE±0.5	08
24	CS500-123-BA-00	198.0*43.7*FREE±0.5	08
25	CS500-124-BA-00	190.0*43.7*FREE±0.5	09
26	CS500-125-BA-00	56.0*20.0*FREE±0.2	09
27	CS500-126-BA-00	56.0*40.0*FREE±0.2	09
28	CS500-127-BA-00	51.0*15.1*FREE±0.2	09
29	CS500-128-BA-00	48.0*16.0*FREE±0.2	09
30	CS500-129-BA-00	48.0*34.0*FREE±0.2	09
31	CS500-130-BA-00	48.0*22.0*FREE±0.2	09
32	CS500-131-BA-00	48.0*17.1*FREE±0.2	09
33	CS500-132-BA-00	18.4*9.5*FREE±0.2	10
34	CS500-133-BA-00	48.0*22.0*FREE±0.2	10
35	CS500-134-BA-00	59.20*12.2*FREE±0.2	10
36	CS500-135-BA-00	59.5*30.0*FREE±0.2	10
37	CS500-136-BA-00	78.0*20.99*FREE±0.2	10
38	CS500-137-BA-00	25.0*12.1*FREE±0.2	10
39	CS500-138-BA-00	150.0*27.67*FREE±0.2	10
40	CS500-139-BA-00	35.0*10.0*FREE±0.2	10
41	CS500-140-BA-00	91.45*12.5*FREE±0.2	11
42	CS500-141-BA-00	20.0*12.0*FREE±0.2	11
43	CS500-142-BA-00	26.92*19.05*FREE±0.2	11
44	CS500-143-BA-00	21.0*8.99*FREE±0.2	11
45	CS500-144-BA-00	18.5*9.5*FREE±0.2	11
46	CS500-145-BA-00	26.0*8.2*FREE±0.2	11
47	CS500-146-BA-00	24.1*6.5*FREE±0.2	11
48	CS500-147-BA-00	89.93*19.62*FREE±0.2	11
49	CS500-148-BA-00	101.6*39.1*FREE±0.2	12
50	CS500-149-BA-00	26.0*7.0*FREE±0.2	12
51	CS500-150-BA-00	20.0*9.14*FREE±0.2	12
52	CS500-151-BA-00	23.0*9.2*FREE±0.2	12

No.	Material Number	Specifications	Page #
53	CS500-152-BA-00	36.83*22.5*FREE±0.2	12
54	CS500-153-BA-00	40.0*18.0*FREE±0.2	12
55	CS500-154-BA-00	36.8*10.44*FREE±0.2	12
56	CS500-155-BA-00	41.95*10.0*FREE±0.2	12
57	CS500-156-BA-00	50.74*10.0*FREE±0.2	13
58	CS500-157-BA-00	50.0*18.75*FREE±0.2	13
59	CS500-158-BA-00	50.8*7.9*FREE±0.2	13
60	CS500-159-BA-00	53.34*10.4*FREE±0.2	13
61	CS500-160-BA-00	35.0*6.6*FREE±0.2	13
62	CS500-161-BA-00	54.0*26.0*FREE±0.2	13
63	CS500-162-BA-00	55.0*23.0*FREE±0.2	13
64	CS500-163-BA-00	92.0*6.45*FREE±0.2	13
65	CS500-164-BA-00	92.0*6.50*FREE±0.2	14
66	CS500-165-BA-00	162.0*29.70*FREE±0.2	14
67	CS500-166-BA-00	65.0*10.5*FREE±0.2	14
68	CS500-167-BA-00	74.93*9.0*FREE±0.2	14
69	CS500-168-BA-00	50.8*8.4*FREE±0.2	14
70	CS500-169-BA-00	62.20*10.0*FREE±0.2	14
71	CS500-170-BA-00	170.0*20.5*FREE±0.5	14
72	CS500-171-BA-00	198.0*43.7*FREE±0.5	14
73	CS500-172-BA-00	190.0*43.7*FREE±0.5	15
74	CS500-173-BA-00	56.0*20.0*FREE±0.2	15
75	CS500-174-BA-00	56.0*40.0*FREE±0.2	15
76	CS500-175-BA-00	51.0*15.1*FREE±0.2	15
77	CS500-176-BA-00	48.0*16.0*FREE±0.2	15
78	CS500-177-BA-00	48.0*34.0*FREE±0.2	15
79	CS500-178-BA-00	48.0*22.0*FREE±0.2	15
80	CS500-179-BA-00	48.0*17.1*FREE±0.2	15
81	CS500-180-BA-00	18.4*9.5*FREE±0.2	16
82	CS500-181-BA-00	48.0*22.0*FREE±0.2	16
83	CS500-182-BA-00	59.20*12.2*FREE±0.2	16
84	CS500-183-BA-00	59.5*30.0*FREE±0.2	16
85	CS500-184-BA-00	78.0*20.99*FREE±0.2	16
86	CS500-185-BA-00	25.0*12.1*FREE±0.2	16
87	CS500-186-BA-00	150.0*27.67*FREE±0.2	16
88	CS500-187-BA-00	35.0*10.0*FREE±0.2	16
89	CS500-188-BA-00	91.45*12.5*FREE±0.2	17
90	CS500-189-BA-00	20.0*12.0*FREE±0.2	17
91	CS500-190-BA-00	26.92*19.05*FREE±0.2	17
92	CS500-191-BA-00	21.0*8.99*FREE±0.2	17
93	CS500-192-BA-00	18.5*9.5*FREE±0.2	17
94	CS500-193-BA-00	26.0*8.2*FREE±0.2	17
95	CS500-194-BA-00	24.1*6.5*FREE±0.2	17
96	CS500-195-BA-00	89.93*19.62*FREE±0.2	17
97	CS500-196-BA-00	87.0*12.3*FREE±0.2	18
98	CS500-197-BA-00	51.55*12.0*FREE±0.2	18
99	CS500-198-BA-00	54.0*22.6*FREE±0.2	18
100	CS500-199-BA-00	14.0*9.0*FREE±0.2	18
101	CS500-200-BA-00	63.5*25.0*FREE±0.2	18
102	CS500-201-BA-00	28.0*25.0*FREE±0.2	18
103	CS500-202-BA-00	110.0*19.0*FREE±0.2	18
104	CS500-203-BA-00	37.55*10.62*FREE±0.2	18

No.	Material Number	Specifications	Page #
105	CS500-204-BA-00	164.5*20.1*FREE±0.2	19
106	CS500-205-BA-00	46.57*11.8*FREE±0.2	19
107	CS500-206-BA-00	44.0*27.47*FREE±0.2	19
108	CS500-207-BA-00	62.0*33.0*FREE±0.2	19
109	CS500-208-BA-00	53.5*30.0*FREE±0.2	19
110	CS500-209-BA-00	55.1*44.1*FREE±0.2	19
111	CS500-210-BA-00	104.0*20.0*FREE±0.2	19
112	CS500-211-BA-00	19.95*7.1*FREE±0.2	19
113	CS500-212-BA-00	11.92*5.7*FREE±0.2	20
114	CS500-213-BA-00	34.5*15.0*FREE±0.2	20
115	CS500-214-BA-00	48.0*22.0*FREE±0.2	20
116	CS500-215-BA-00	42.0*32.0*FREE±0.2	20
117	CS500-216-BA-00	37.5*13.0*FREE±0.2	20
118	CS500-217-BA-00	31.6*9.8*FREE±0.2	20
119	CS500-218-BA-00	51.0*15.1*FREE±0.2	20
120	CS500-219-BA-00	15.7*13.5*FREE±0.2	20
121	CS500-220-BA-00	10.0*10.0*FREE±0.2	21
122	CS500-221-BA-00	10.0*10.0*FREE±0.2	21
123	CS500-222-BA-00	30.0*10.0*FREE±0.2	21
124	CS500-223-BA-00	27.0*20.0*FREE±0.2	21
125	CS500-224-BA-00	27.0*10.0*FREE±0.2	21
126	CS500-225-BA-00	25.0*20.0*FREE±0.2	21
127	CS500-226-BA-00	25.0*10.0*FREE±0.2	21
128	CS500-227-BA-00	23.0*20.0*FREE±0.2	21
129	CS500-228-BA-00	10.0*20.0*FREE±0.2	22
130	CS500-229-BA-00	23.0*10.0*FREE±0.2	22
131	CS500-230-BA-00	50.0*5.0*FREE±0.2	22
132	CS500-231-BA-00	45.0*10.0*FREE±0.2	22
133	CS500-232-BA-00	40.0*10.0*FREE±0.2	22
134	CS500-233-BA-00	35.0*20.0*FREE±0.2	22
135	CS500-234-BA-00	35.0*10.0*FREE±0.2	22
136	CS500-235-BA-00	63.95*20.1*FREE±0.2	22
137	CS500-236-BA-00	63.95*10.1*FREE±0.2	23
138	CS500-237-BA-00	39.05*10.1*FREE±0.2	23
139	CS500-238-BA-00	39.05*20.1*FREE±0.2	23
140	CS500-239-BA-00	40.0*20.0*FREE±0.2	23
141	CS500-240-BA-00	44.0*10.1*FREE±0.2	23
142	CS500-241-BA-00	44.0*20.1*FREE±0.2	23
143	CS500-242-BA-00	53.96*10.1*FREE±0.2	23
144	CS500-243-BA-00	53.96*20.1*FREE±0.2	23
145	CS500-244-BA-00	58.95*10.1*FREE±0.2	24
146	CS500-245-BA-00	58.95*20.1*FREE±0.2	24
147	CS500-246-BA-00	70.0*16.0*FREE±0.2	24
148	CS500-247-BA-00	70.0*19.08*FREE±0.2	24
149	CS500-248-BA-00	45.0*9.15*FREE±0.2	24
150	CS500-249-BA-00	63.49*19.2*FREE±0.2	24
151	CS500-250-BA-00	54.0*24.0*FREE±0.2	24
152	CS500-251-BA-00	58.0*18.0*FREE±0.2	24
153	CS500-252-BA-00	180.01*32.81*FREE±0.2	25
154	CS500-253-BA-00	52.0*20.7*FREE±0.2	25
155	CS500-254-BA-00	56.0*20.0*FREE±0.2	25
156	CS500-255-BA-00	96.0*40.0*FREE±0.2	25

No.	Material Number	Specifications	Page #
157	CS500-256-BA-00	56.2*20.0*FREE±0.2	25
158	CS500-257-BA-00	34.0*5.0*FREE±0.2	25
159	CS500-258-BA-00	159.87*63.87*FREE±0.2	25
160	CS500-259-BA-00	57.91*11.54*FREE±0.2	25
161	CS500-260-BA-00	47.0*7.5*FREE±0.2	26
162	CS500-261-BA-00	40.0*11.0*FREE±0.2	26
163	CS500-262-BA-00	44.5*6.0*FREE±0.2	26
164	CS500-263-BA-00	44.5*5.0*FREE±0.2	26
165	CS500-264-BA-00	32.0*25.1*FREE±0.2	26
166	CS500-265-BA-00	90.0*24.8*FREE±0.2	26
167	CS500-266-BA-00	64.8*6.6*FREE±0.2	26
168	CS500-267-BA-00	53.55*20.6*FREE±0.2	26
169	CS500-268-BA-00	44.35*13.3*FREE±0.2	27
170	CS500-269-BA-00	38.0*7.5*FREE±0.2	27
171	CS500-270-BA-00	45.0*8.0*FREE±0.2	27
172	CS500-271-BA-00	72.0*30.0*FREE±0.2	27
173	CS500-272-BA-00	27.0*5.6*FREE±0.2	27
174	CS500-273-BA-00	35.0*21.5*FREE±0.2	27
175	CS500-274-BA-00	78.0*2.0*FREE±0.2	27
176	CS500-275-BA-00	38.0*7.5*FREE±0.2	27
177	CS500-276-BA-00	50.2*13.3*FREE±0.2	28
178	CS500-277-BA-00	33.1*22.1*FREE±0.2	28
179	CS500-278-BA-00	44.85*28.15*FREE±0.2	28
180	CS500-279-BA-00	43.0*7.6*FREE±0.2	28
181	CS500-280-BA-00	43.0*7.2*FREE±0.2	28
182	CS500-281-BA-00	44.9*11.2*FREE±0.2	28
183	CS500-282-BA-00	81.3*13.3*FREE±0.2	28
184	CS500-283-BA-00	29.75*6.5*FREE±0.2	28
185	CS500-284-BA-00	23.0*7.6*FREE±0.2	29
186	CS500-285-BA-00	80.0*21.0*FREE±0.2	29
187	CS500-286-BA-00	25.0*18.0*FREE±0.2	29
188	CS500-287-BA-00	37.0*8.0*FREE±0.2	29
189	CS500-288-BA-00	29.0*21.0*FREE±0.2	29
190	CS500-289-BA-00	50.8*8.9*FREE±0.2	29
191	CS500-290-BA-00	58.3*5.0*FREE±0.2	29
192	CS500-291-BA-00	41.8*19.0*FREE±0.2	29
193	CS500-292-BA-00	170.0*20.5*FREE±0.2	30
194	CS500-293-BA-00	60.0*18.0*FREE±0.2	30
195	CS500-294-BA-00	114.0*10.0*FREE±0.2	30
196	CS500-295-BA-00	36.8*22.5*FREE±0.2	30
197	CS500-296-BA-00	20.0*9.5*FREE±0.2	30
198	CS500-297-BA-00	74.0*12.0*FREE±0.2	30
199	CS500-298-BA-00	39.9*8.7*FREE±0.2	30
200	CS500-299-BA-00	39.9*8.0*FREE±0.2	30
201	CS500-300-BA-00	95.0*11.25*FREE±0.2	31
202	CS500-301-BA-00	35.0*35.0*FREE±0.2	31
203	CS500-302-BA-00	48.79*48.9*FREE±0.2	31
204	CS500-303-BA-00	50.0*50.0*FREE±0.2	31
205	CS500-304-BA-00	61.0*61.0*FREE±0.2	31
206	CS500-305-BA-00	Ø120.0*FREE±0.2	31

Material: Aluminum 6063-T5
Multiple types of finishes are available.

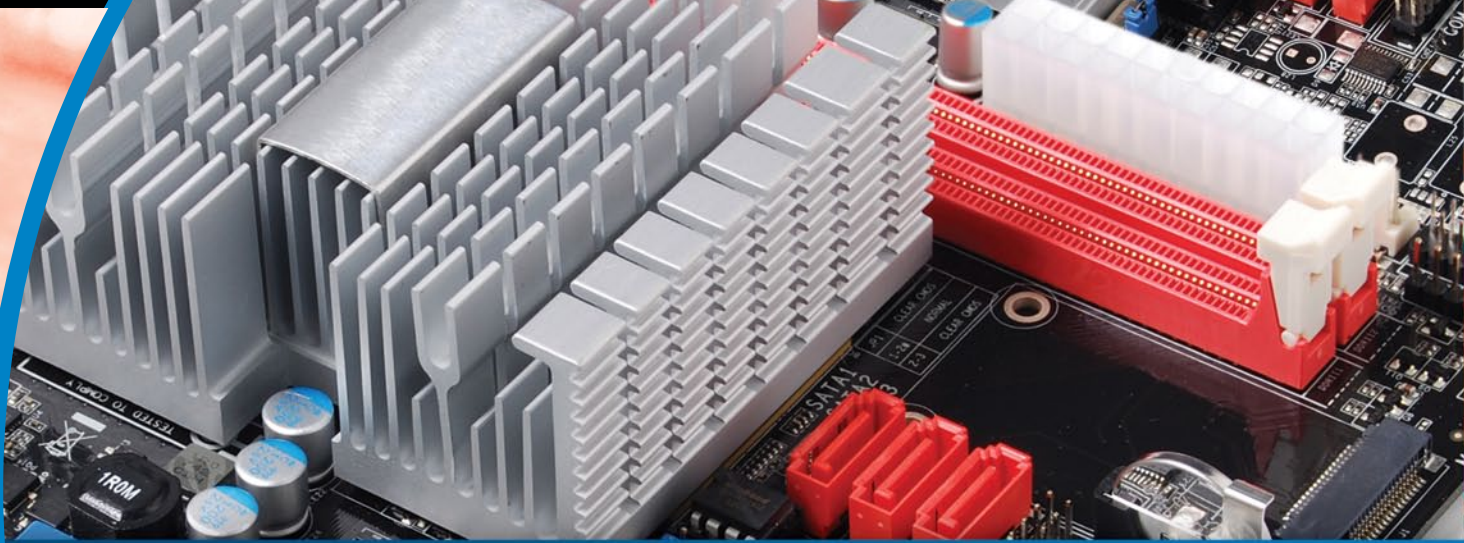

MISSION STATEMENT

Cooling Source aims to deliver the highest value of services and products in a timely manner to our customers as the premier thermal solutions manufacturer, designer and service company.

COMPANY INTRODUCTION

Cooling Source, Inc. offers the most comprehensive value-added standard and custom heatsink solutions, including the latest technology to a wide range of markets. We provide design assistance and thermal analysis to help you achieve your goals. We will deliver the highest value to our customers as the premier manufacturer, designer and Service Company. Our ISO 9001-2008 and ISO 14001 certified manufacturing plant is based in main land China to ensure you the lowest cost, best quality and supply chain continuity for your volume production.

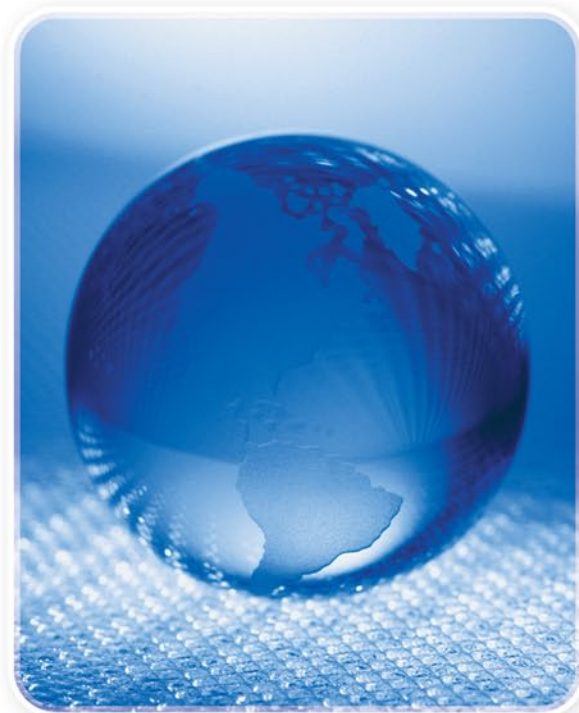

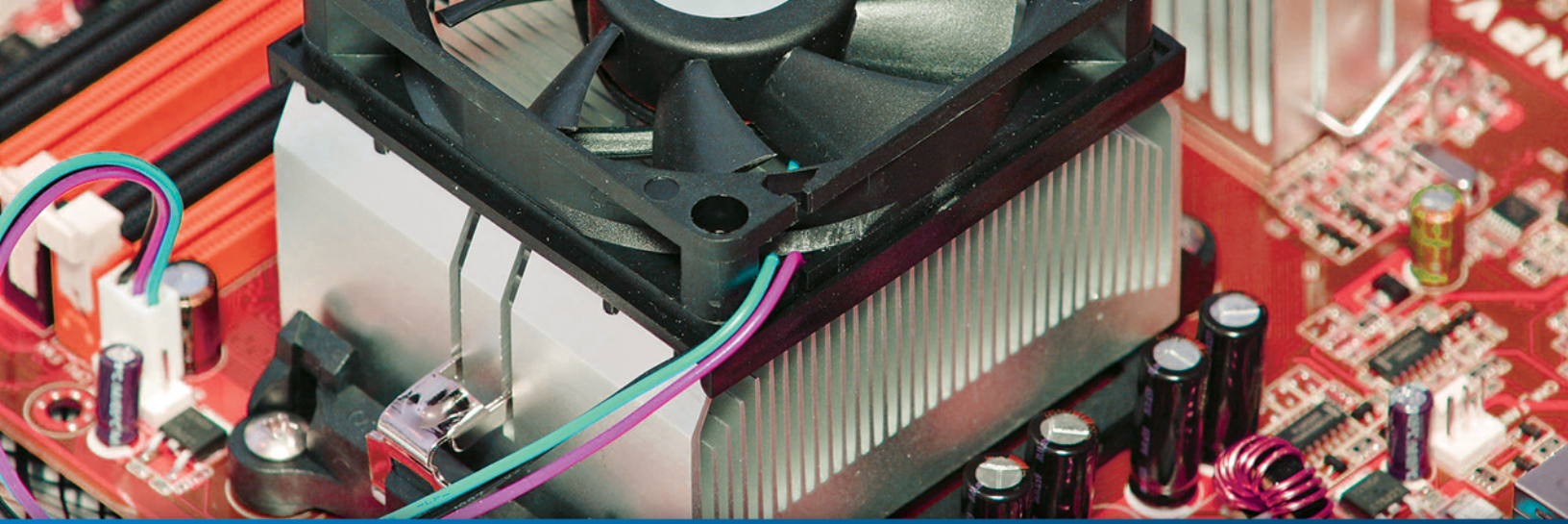

COOLING SOURCE - THE DIFFERENCE

- Provide CFD modeling of heat sinks, boards and assemblies
- Mechanical design assistance on thermal solutions and attachments
- Broadest range of manufacturing processes
- Flexible fin shape designs
- Market leader in heat-pipe solutions
- Rapid prototyping for the validation of new projects
- Dedicated customer service and support
- Competitive global market cost
- Quality System: ISO 9001-2000 certified
- 100% inspection and testing of heat sink, heat-pipe and assembly
- Short lead times

DESIGN FLEXIBILITY

Cooling Source provides the broadest range of manufacturing processes to ensure you the most cost effective thermal solution.

- Die Casting
- Machining
- Extrusion – High aspect ratio
- Folded Fin
- Forging
- Skived Fin
- Swaged Fin
- Stamped Fin
- Heat-pipe Assembly

1

COST EFFECTIVE MANUFACTURING

- Manufacture your volume requirements at our facility located in Shenzhen, China.
- RFQs, order placements and coordination performed by US - based personnel.
- Engineering and local customer service support.
- ISO 9001- 2000 certified manufacturing facility.
- High quality components with competitive, global market cost.
- Utilize suitable manufacturing processes to ensure lowest production cost.

2

ENGINEERING SUPPORT

- Provide thermal analysis of heat sinks, assemblies and boards for new designs using CFD modeling.
- Quick turn-around of prototypes and pre-production quantities to support short design cycles.
- Provide design proposal of heat sinks and thermal solution assemblies.

3

01

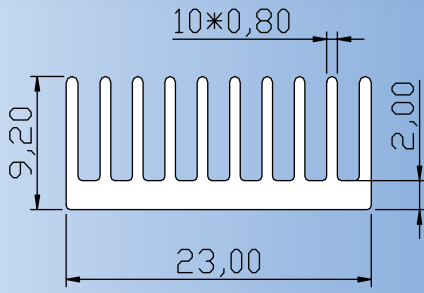

CS500-100-BA-00

Spec: 23.00*9.20*FREE±0.2

02

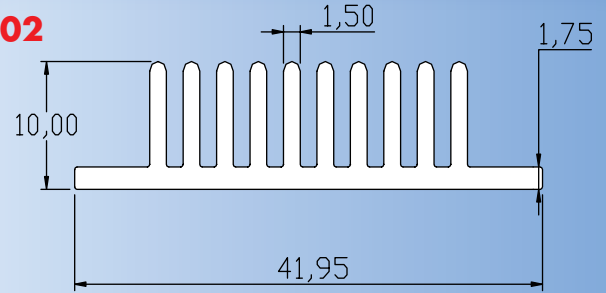

CS500-101-BA-00

Spec: 41.95*10.0*FREE±0.2

03

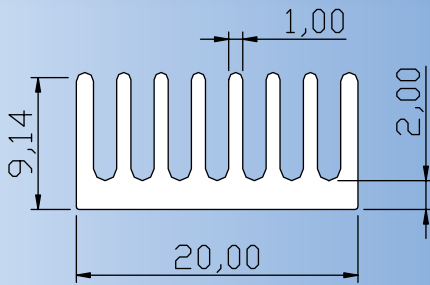

CS500-102-BA-00

Spec: 20.0*9.14*FREE±0.2

04

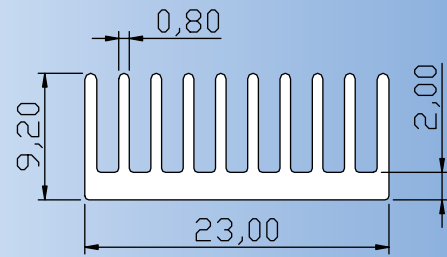

CS500-103-BA-00

Spec: 23*9.2*FREE±0.2

05

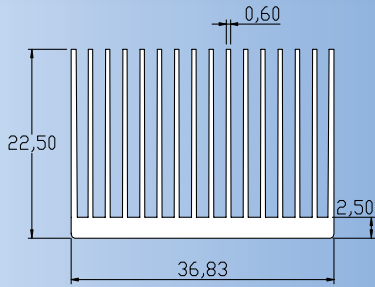

CS500-104-BA-00

Spec: 36.83*22.5*FREE±0.2

06

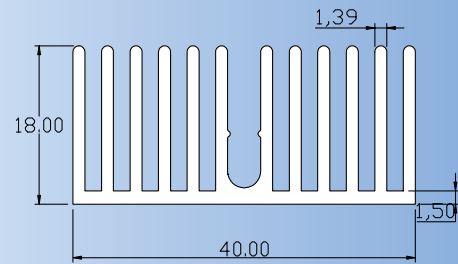

CS500-105-BA-00

Spec: 40.0*18.0*FREE±0.2

07

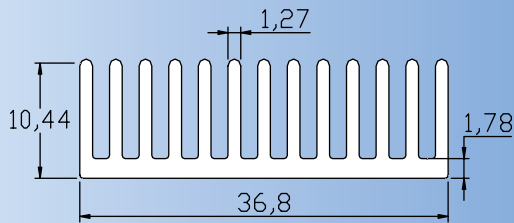

CS500-106-BA-00

Spec: 36.8*10.44*FREE±0.2

08

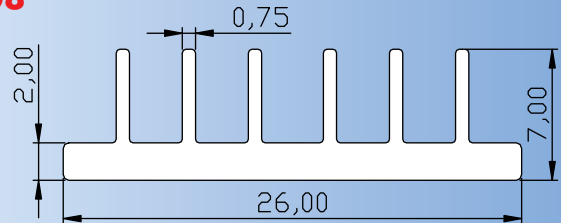

CS500-107-BA-00

Spec: 26.0*7.0*FREE±0.2

09

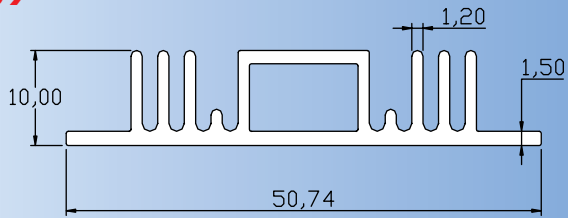

CS500-108-BA-00

Spec: 50.74*10.0*FREE±0.2

10

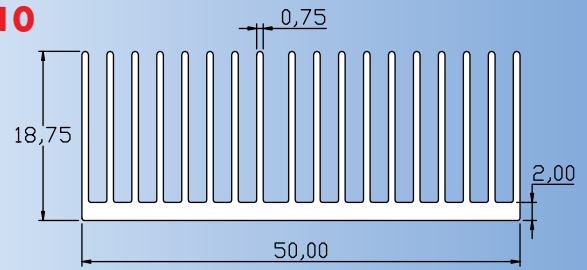

CS500-109-BA-00

Spec: 50.0*18.75*FREE±0.2

11

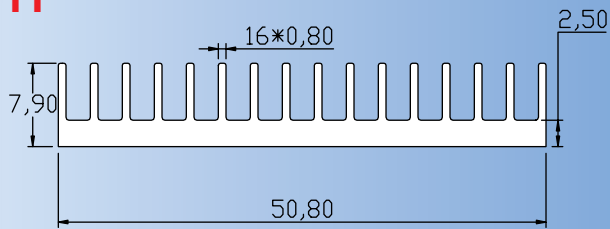

CS500-110-BA-00

Spec: 50.8*7.9*FREE±0.2

12

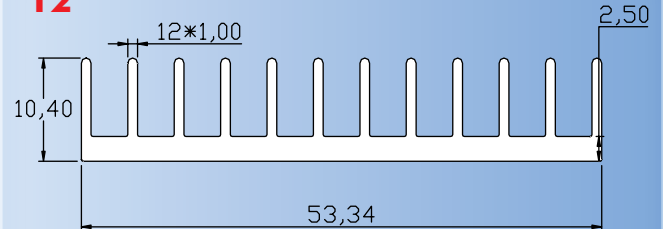

CS500-111-BA-00

Spec: 53.34*10.4*FREE±0.2

13

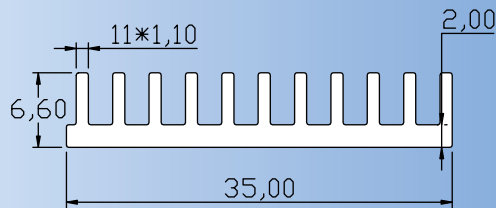

CS500-112-BA-00

Spec: 35.0*6.6*FREE±0.2

14

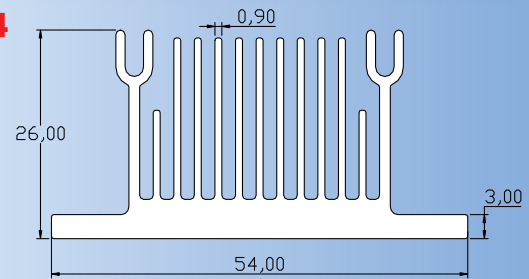

CS500-113-BA-00

Spec: 54.0*26.0*FREE±0.2

15

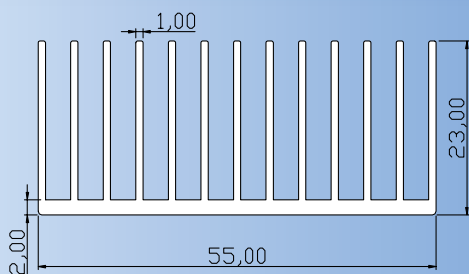

CS500-114-BA-00

Spec: 55.0*23.0*FREE±0.2

16

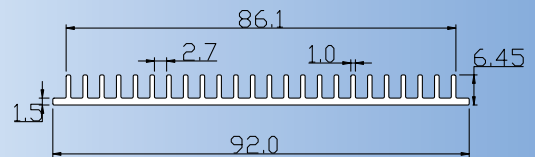

CS500-115-BA-00

Spec: 92.0*6.45*FREE±0.2

17

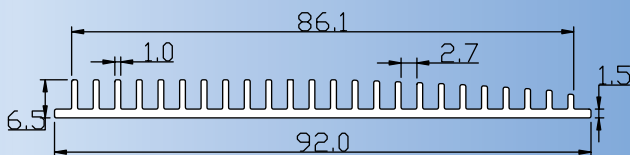

CS500-116-BA-00

Spec: 92.0*6.50*FREE±0.2

18

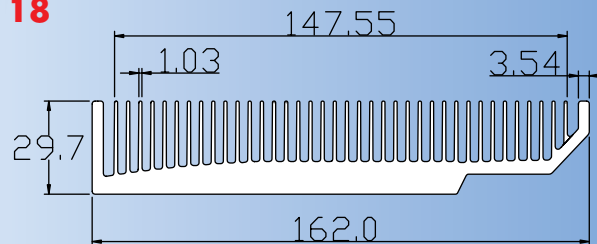

CS500-117-BA-00

Spec: 162.0*29.70*FREE±0.2

19

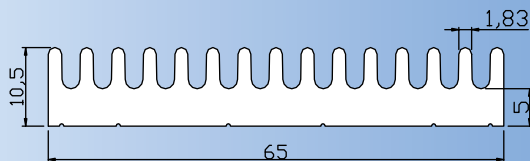

CS500-118-BA-00

Spec: 65.0*10.5*FREE±0.2

20

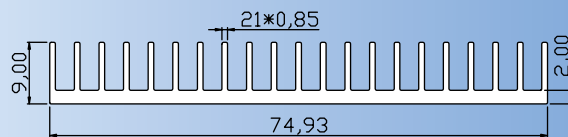

CS500-119-BA-00

Spec: 74.93*9.0*FREE±0.2

21

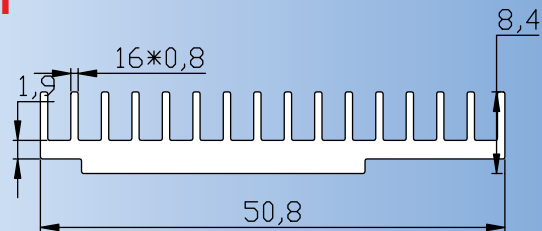

CS500-120-BA-00

Spec: 50.8*8.4*FREE±0.2

22

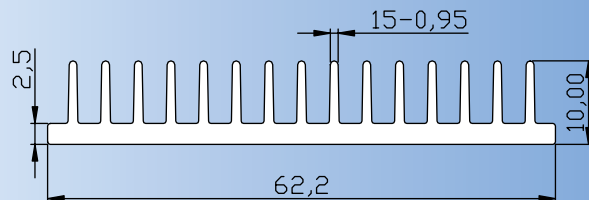

CS500-121-BA-00

Spec: 62.20*10.0*FREE±0.2

23

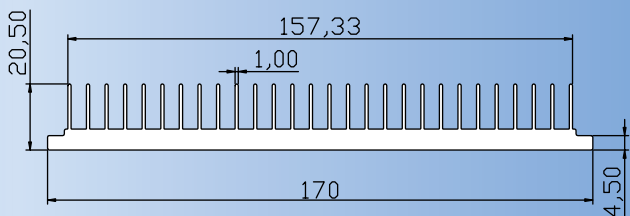

CS500-122-BA-00

Spec: 170.0*20.5*FREE±0.5

24

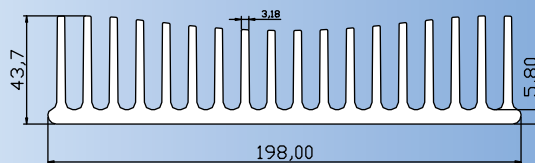

CS500-123-BA-00

Spec: 198.0*43.7*FREE±0.5

25

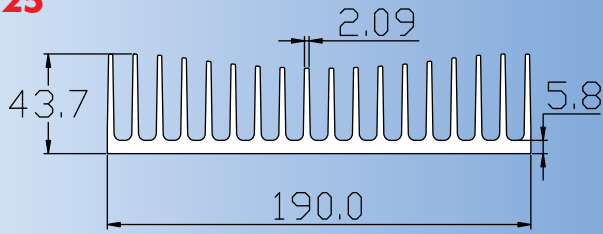

CS500-124-BA-00

Spec: 190.0*43.7*FREE±0.5

26

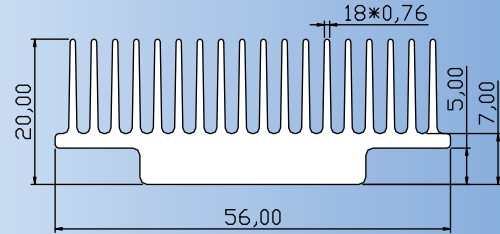

CS500-125-BA-00

Spec: 56.0*20.0*FREE±0.2

27

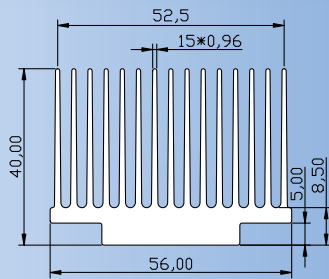

CS500-126-BA-00

Spec: 56.0*40.0*FREE±0.2

28

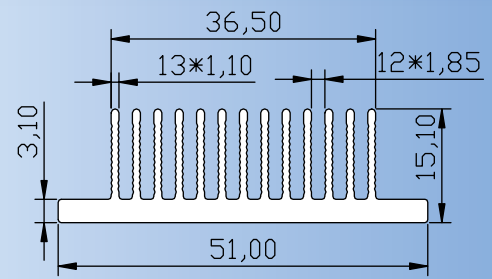

CS500-127-BA-00

Spec: 51.0*15.1*FREE±0.2

29

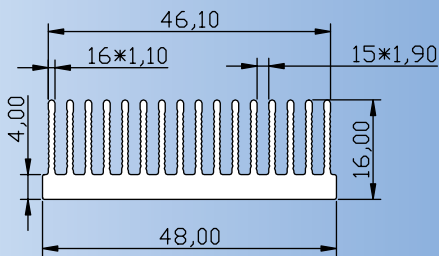

CS500-128-BA-00

Spec: 48.0*16.0*FREE±0.2

30

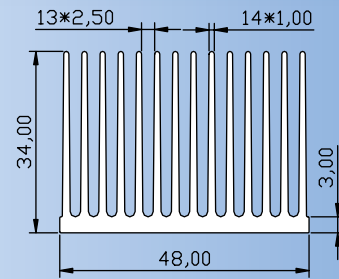

CS500-129-BA-00

Spec: 48.0*34.0*FREE±0.2

31

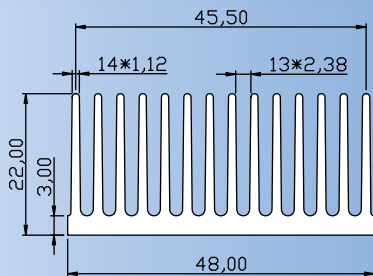

CS500-130-BA-00

Spec: 48.0*22.0*FREE±0.2

32

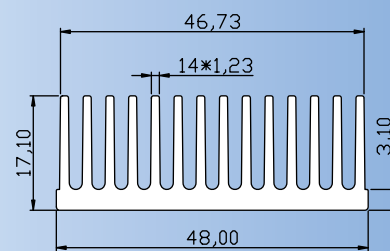

CS500-131-BA-00

Spec: 48.0*17.1*FREE±0.2

33

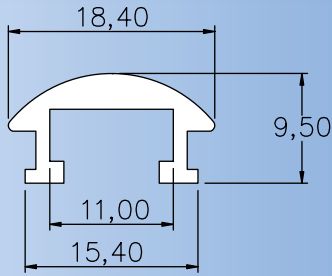

CS500-132-BA-00

Spec: 18.4*9.5*FREE±0.2

34

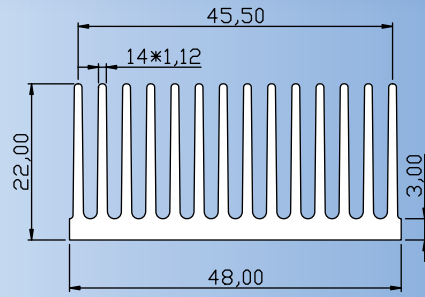

CS500-133-BA-00

Spec: 48.0*22.0*FREE±0.2

35

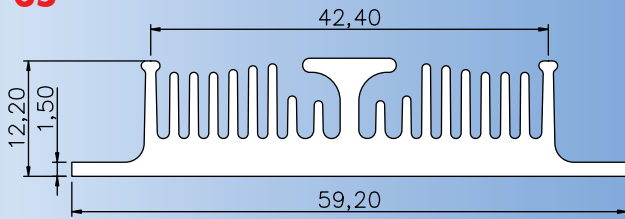

CS500-134-BA-00

Spec: 59.20*12.2*FREE±0.2

36

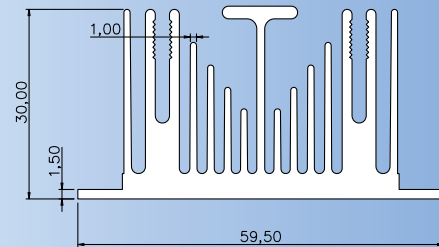

CS500-135-BA-00

Spec: 59.5*30.0*FREE±0.2

37

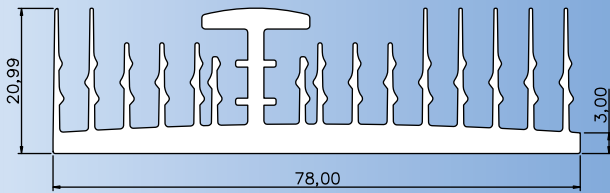

CS500-136-BA-00

Spec: 78.0*20.99*FREE±0.2

38

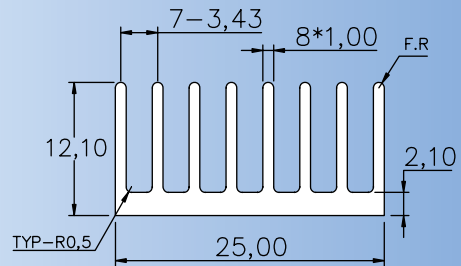

CS500-137-BA-00

Spec: 25.0*12.1*FREE±0.2

39

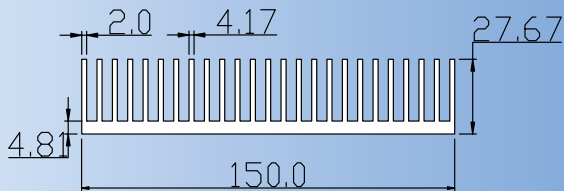

CS500-138-BA-00

Spec: 150.0*27.67*FREE±0.2

40

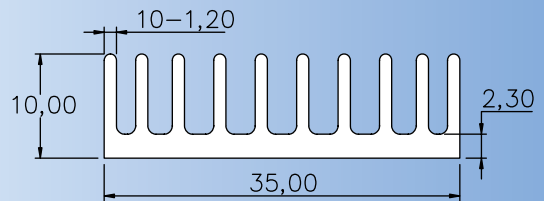

CS500-139-BA-00

Spec: 35.0*10.0*FREE±0.2

41

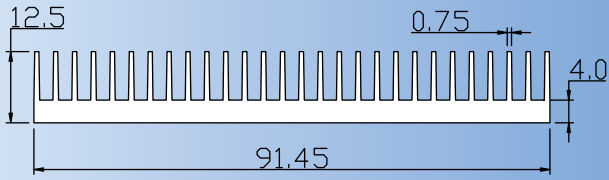

CS500-140-BA-00

Spec: 91.45*12.5*FREE±0.2

42

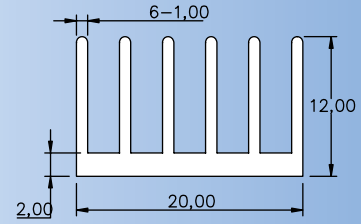

CS500-141-BA-00

Spec: 20.0*12.0*FREE±0.2

43

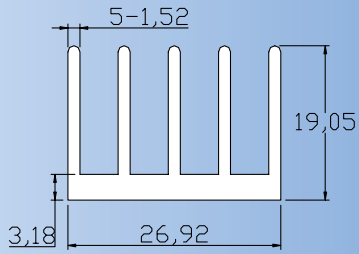

CS500-142-BA-00

Spec: 26.92*19.05*FREE±0.2

44

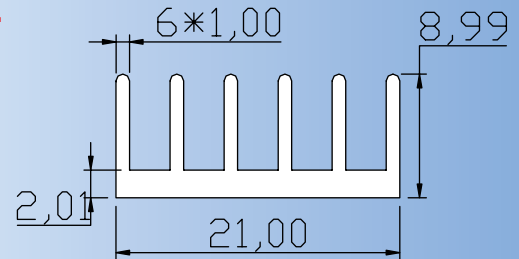

CS500-143-BA-00

Spec: 21.0*8.99*FREE±0.2

45

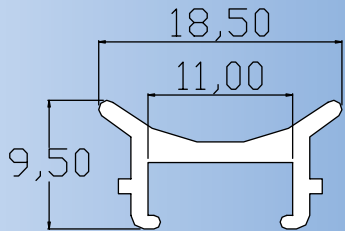

CS500-144-BA-00

Spec: 18.5*9.5*FREE±0.2

46

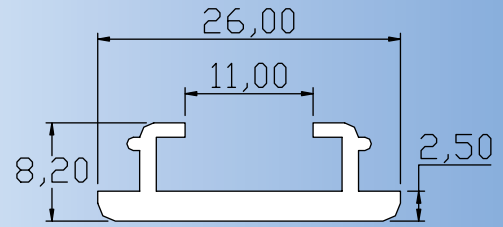

CS500-145-BA-00

Spec: 26.0*8.2*FREE±0.2

47

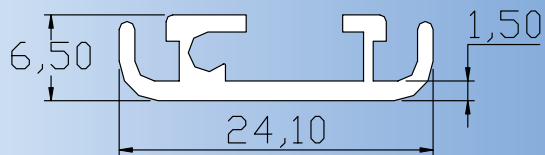

CS500-146-BA-00

Spec: 24.1*6.5*FREE±0.2

48

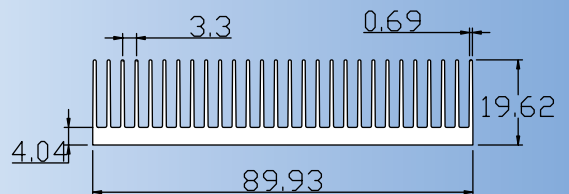

CS500-147-BA-00

Spec: 89.93*19.62*FREE±0.2

49

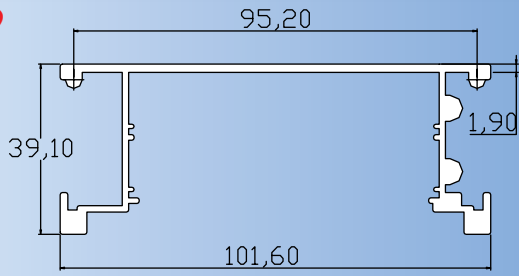

CS500-148-BA-00

Spec: 101.6*39.1*FREE±0.2

50

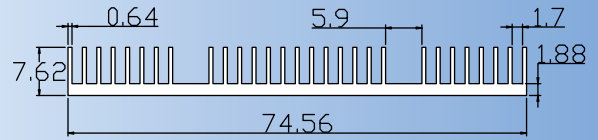

CS500-149-BA-00

Spec: 74.56*7.62*FREE±0.2

51

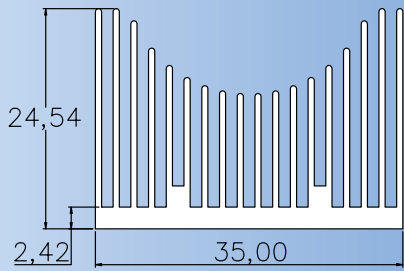

CS500-150-BA-00

Spec: 35.0*24.54*FREE±0.2

52

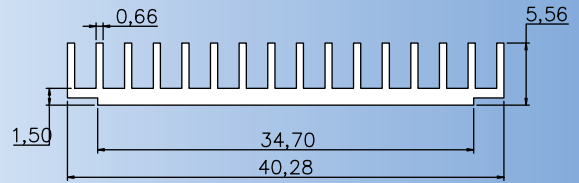

CS500-151-BA-00

Spec: 40.28*5.56*FREE±0.2

53

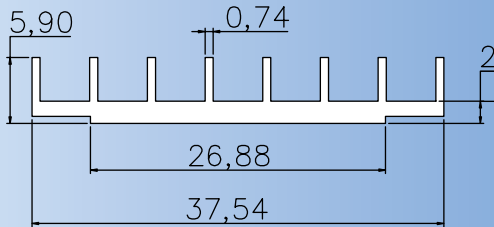

CS500-152-BA-00

Spec: 37.54*5.9*FREE±0.2

54

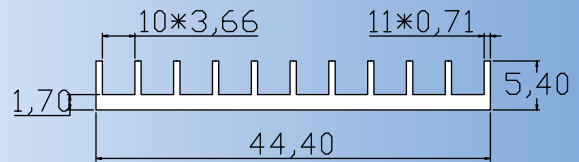

CS500-153-BA-00

Spec: 44.4*5.40*FREE±0.2

55

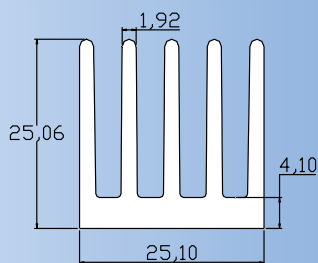

CS500-154-BA-00

Spec: 25.1*25.06*FREE±0.2

56

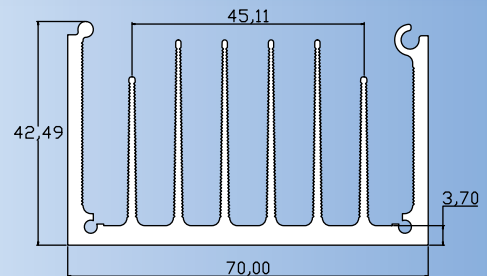

CS500-155-BA-00

Spec: 70.0*42.49*FREE±0.2

57

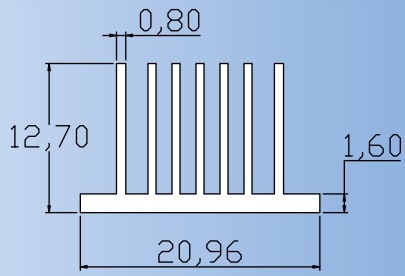

CS500-156-BA-00

Spec: 20.96*12.7*FREE±0.2

58

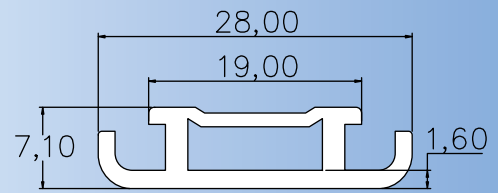

CS500-157-BA-00

Spec: 28.0*7.1*FREE±0.2

59

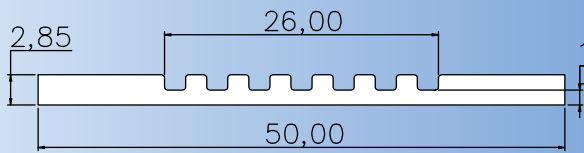

CS500-158-BA-00

Spec: 50.0*2.85*FREE±0.2

60

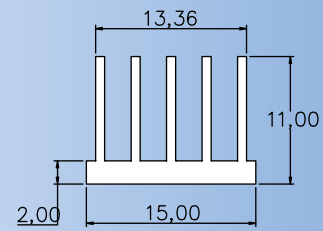

CS500-159-BA-00

Spec: 15.0*11.0*FREE±0.2

61

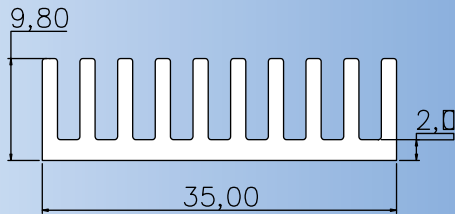

CS500-160-BA-00

Spec: 35.0*9.8*FREE±0.2

62

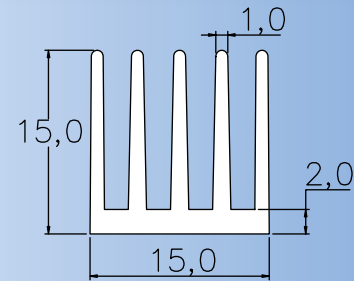

CS500-161-BA-00

Spec: 15.0*15.0*FREE±0.2

63

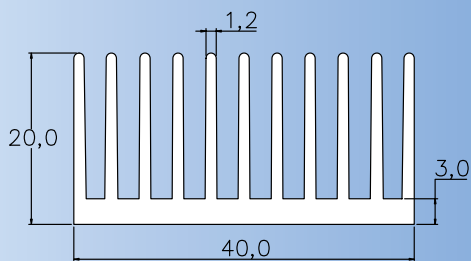

CS500-162-BA-00

Spec: 40.0*20.0*FREE±0.2

64

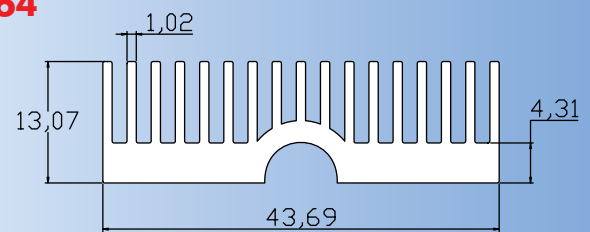

CS500-163-BA-00

Spec: 43.69*13.07*FREE±0.2

65

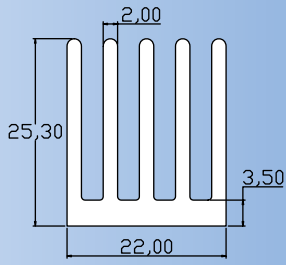

CS500-164-BA-00

Spec: 22.0*25.3*FREE±0.2

66

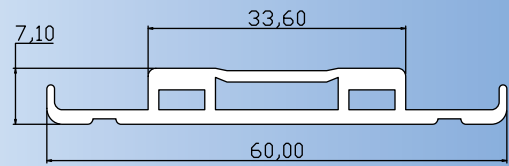

CS500-165-BA-00

Spec: 60.0*7.1*FREE±0.2

67

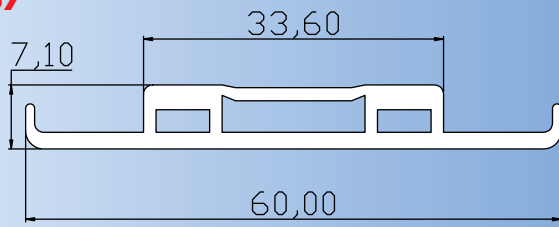

CS500-166-BA-00

Spec: 60.0*7.1*FREE±0.2

68

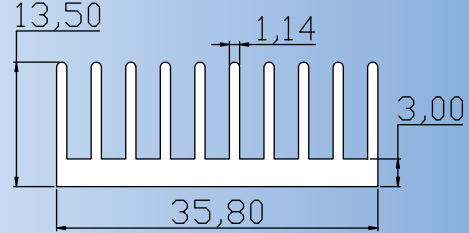

CS500-167-BA-00

Spec: 35.8*13.5*FREE±0.2

69

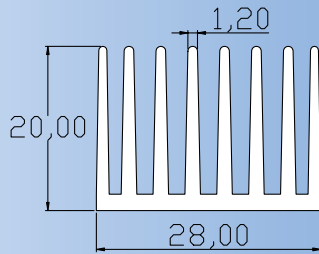

CS500-168-BA-00

Spec: 28.0*20.0*FREE±0.2

70

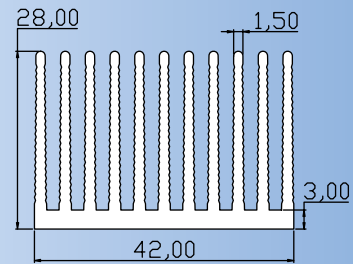

CS500-169-BA-00

Spec: 42.0*28.0*FREE±0.2

71

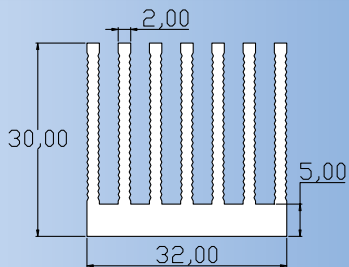

CS500-170-BA-00

Spec: 32.0*30.0*FREE±0.2

72

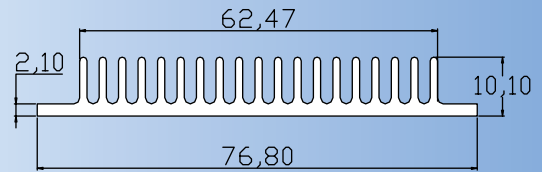

CS500-171-BA-00

Spec: 76.8*10.1*FREE±0.2

73

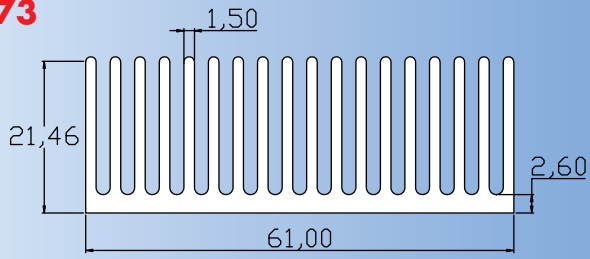

CS500-172-BA-00

Spec: 61.0*22.1*FREE±0.2

74

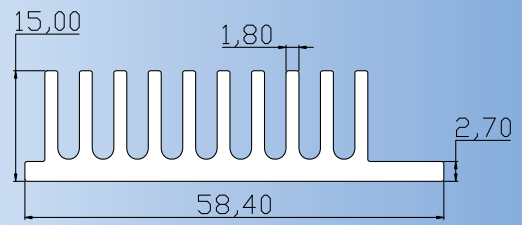

CS500-173-BA-00

Spec: 58.4*15.0*FREE±0.2

75

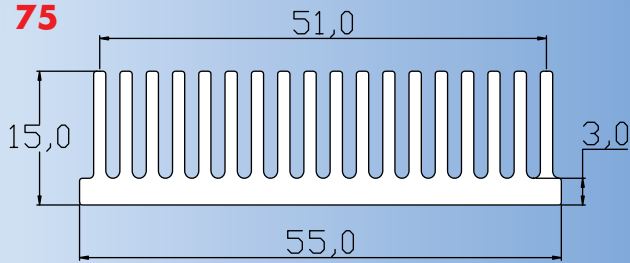

CS500-174-BA-00

Spec: 55.0*15.0*FREE±0.2

76

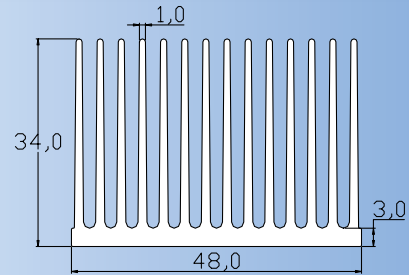

CS500-175-BA-00

Spec: 48.0*34.0*FREE±0.2

77

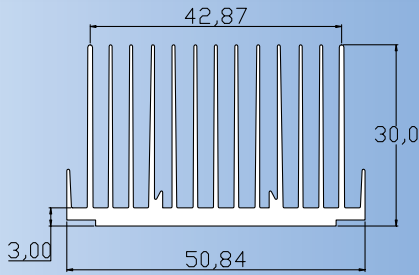

CS500-176-BA-00

Spec: 50.84*30.0*FREE±0.2

78

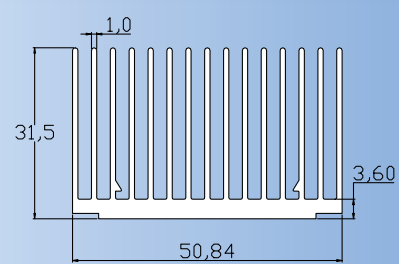

CS500-177-BA-00

Spec: 50.84*31.5*FREE±0.2

79

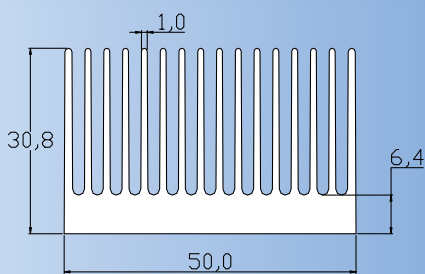

CS500-178-BA-00

Spec: 50.0*30.8*FREE±0.2

80

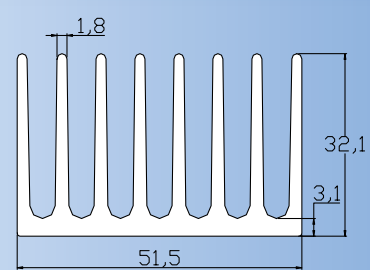

CS500-179-BA-00

Spec: 51.5*32.1*FREE±0.2

81

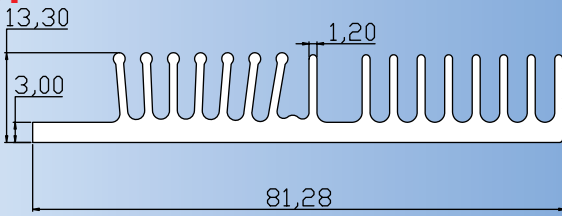

CS500-180-BA-00

Spec: 81.28*13.3*FREE±0.2

82

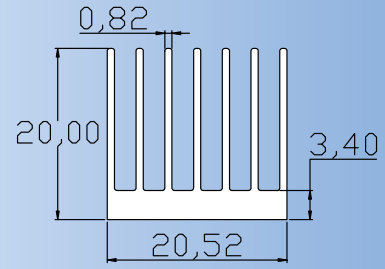

CS500-181-BA-00

Spec: 20.52*20.0*FREE±0.2

83

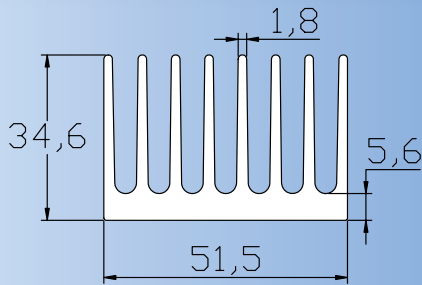

CS500-182-BA-00

Spec: 51.5*34.6*FREE±0.2

84

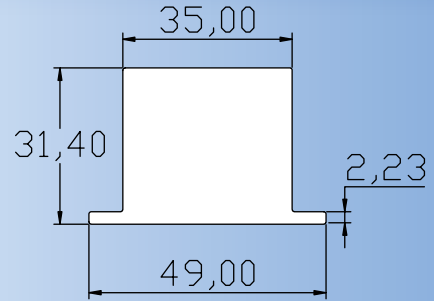

CS500-183-BA-00

Spec: 49.0*31.4*FREE±0.2

85

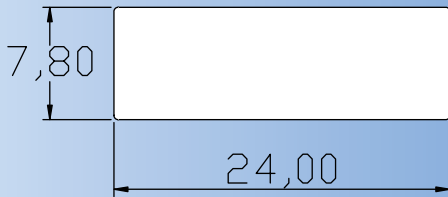

CS500-184-BA-00

Spec: 24.0*7.8*FREE±0.2

86

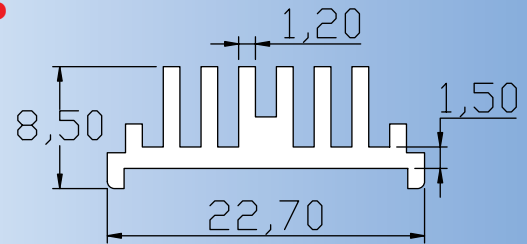

CS500-185-BA-00

Spec: 22.7*8.5*FREE±0.2

87

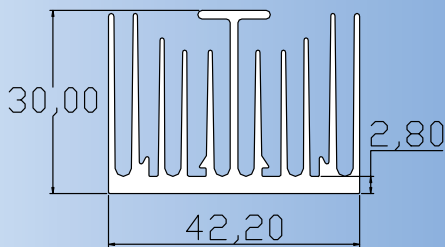

CS500-186-BA-00

Spec: 42.2*30.0*FREE±0.2

88

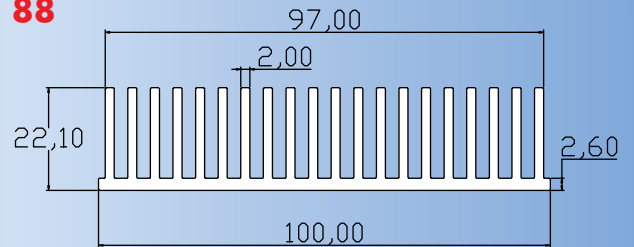

CS500-187-BA-00

Spec: 100.0*22.1*FREE±0.2

89

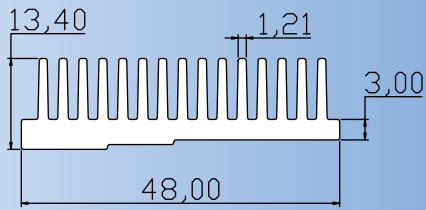

CS500-188-BA-00

Spec: 48.0*13.4*FREE±0.2

90

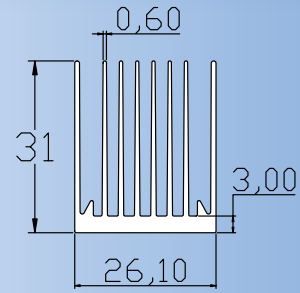

CS500-189-BA-00

Spec: 26.1*31.0*FREE±0.2

91

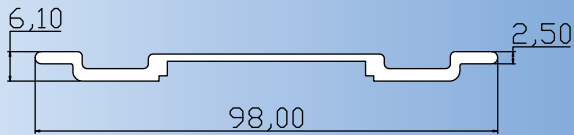

CS500-190-BA-00

Spec: 98.0*6.1*FREE±0.2

92

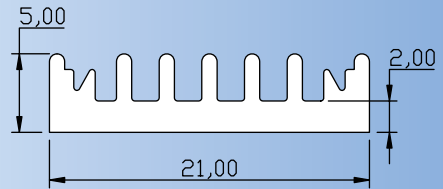

CS500-191-BA-00

Spec: 21.0*5.0*FREE±0.2

93

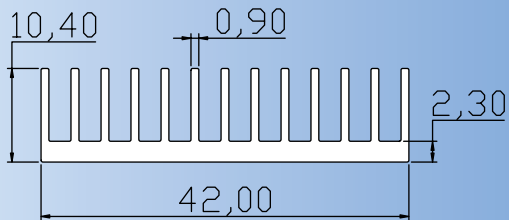

CS500-192-BA-00

Spec: 42.0*10.4*FREE±0.2

94

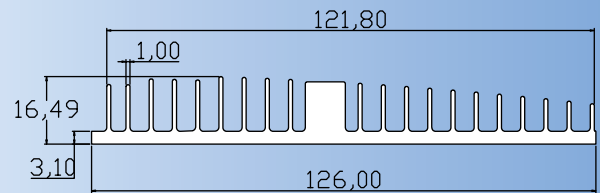

CS500-193-BA-00

Spec: 126.0*16.49*FREE±0.2

95

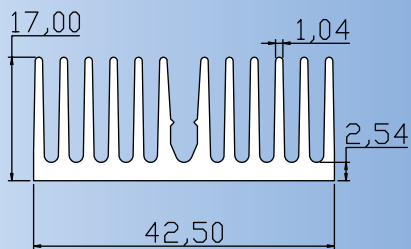

CS500-194-BA-00

Spec: 42.5*17.0*FREE±0.2

96

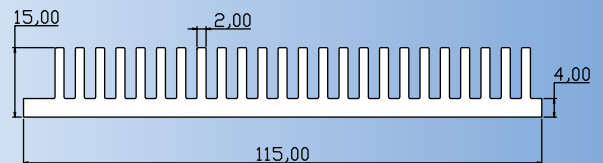

CS500-195-BA-00

Spec: 115.0*15.0*FREE±0.2

97

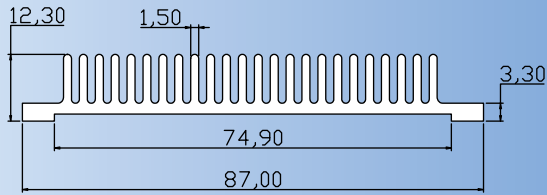

CS500-196-BA-00

Spec: 87.0*12.3*FREE±0.2

98

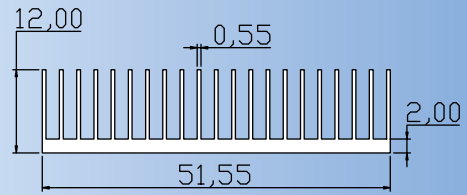

CS500-197-BA-00

Spec: 51.55*12.0 *FREE±0.2

99

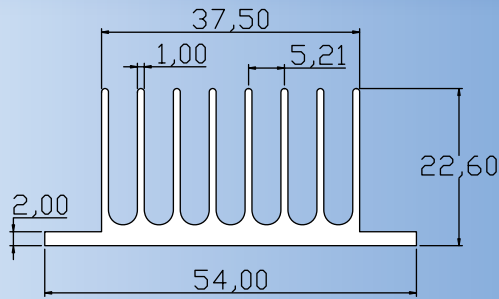

CS500-198-BA-00

Spec: 54.0*22.6*FREE±0.2

100

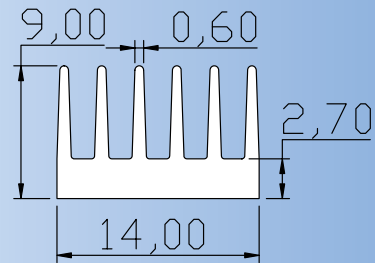

CS500-199-BA-00

Spec: 14.0*9.0*FREE±0.2

101

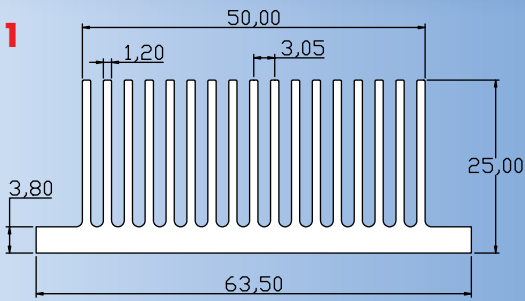

CS500-200-BA-00

Spec: 63.5*25.0*FREE±0.2

102

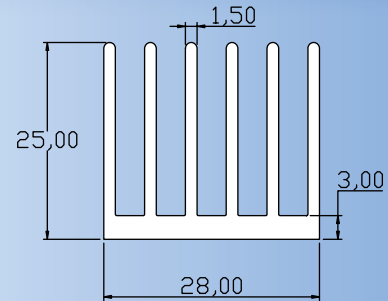

CS500-201-BA-00

Spec: 28.0*25.0*FREE±0.2

103

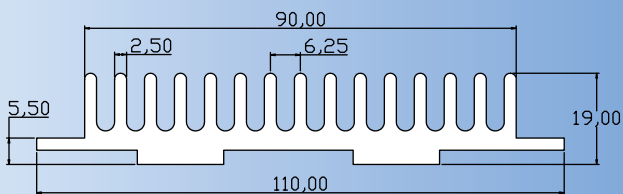

CS500-202-BA-00

Spec: 110.0*19.0*FREE±0.2

104

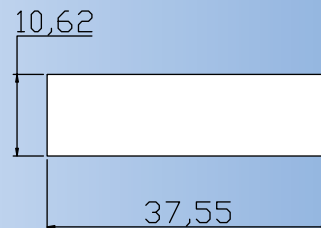

CS500-203-BA-00

Spec: 37.55*10.62*FREE±0.2

105

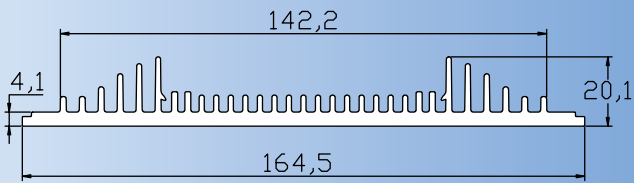

CS500-204-BA-00

Spec: 164.5*20.1*FREE±0.2

106

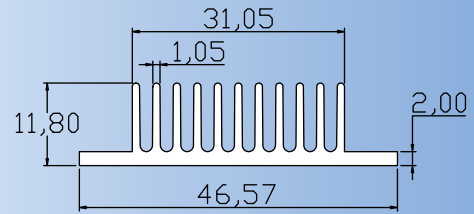

CS500-205-BA-00

Spec: 46.57 *11.8*FREE±0.2

107

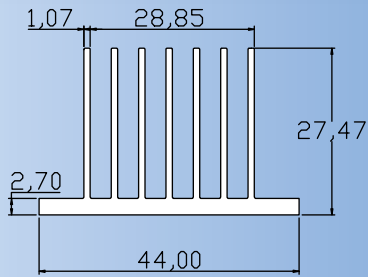

CS500-206-BA-00

Spec: 44.0*27.47*FREE±0.2

108

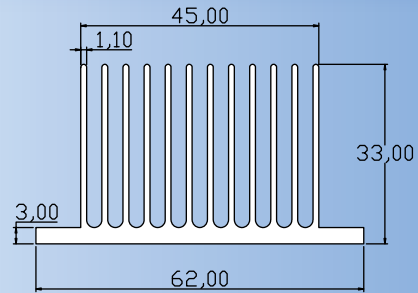

CS500-207-BA-00

Spec: 62.0*33.0*FREE±0.2

109

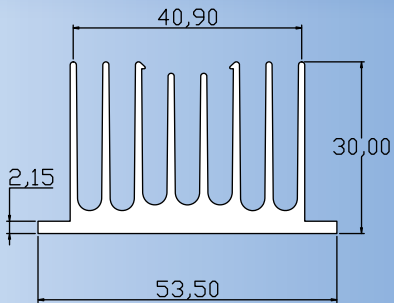

CS500-208-BA-00

Spec: 53.5*30.0*FREE±0.2

110

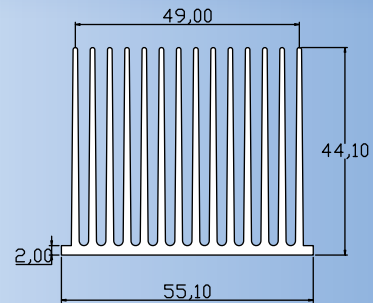

CS500-209-BA-00

Spec: 55.1*44.1*FREE±0.2

111

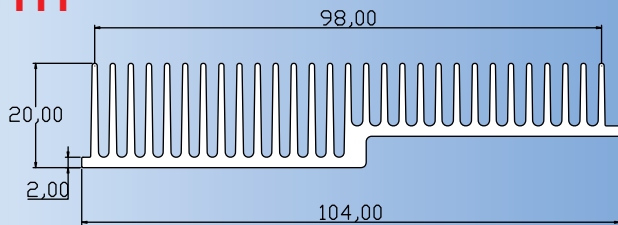

CS500-210-BA-00

Spec: 104.0*20.0*FREE±0.2

112

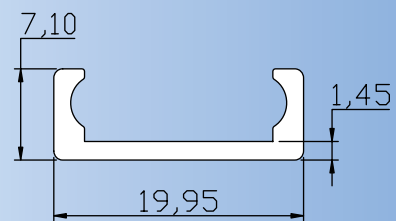

CS500-211-BA-00

Spec: 19.95*7.1*FREE±0.2

113

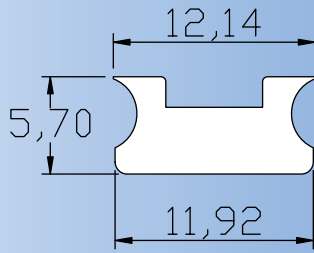

CS500-212-BA-00

Spec: 11.92*5.7*FREE±0.2

114

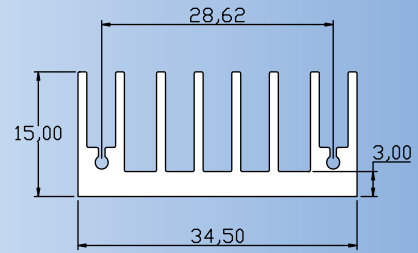

CS500-213-BA-00

Spec: 34.5*15.0*FREE±0.2

115

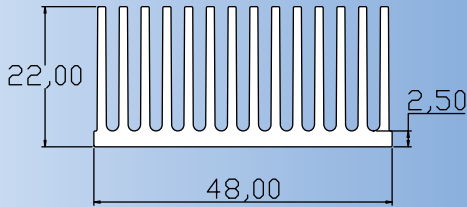

CS500-214-BA-00

Spec: 48.0*22.0*FREE±0.2

116

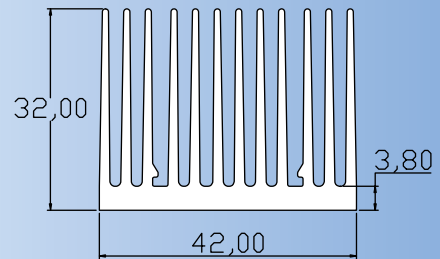

CS500-215-BA-00

Spec: 42.0*32.0*FREE±0.2

117

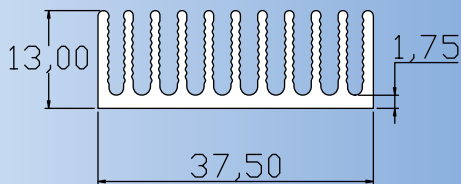

CS500-216-BA-00

Spec: 37.5*13.0*FREE±0.2

118

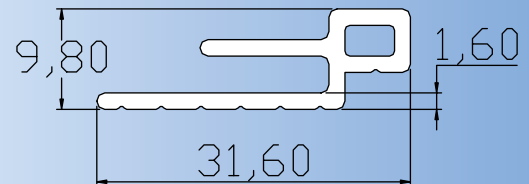

CS500-217-BA-00

Spec: 31.6*9.8*FREE±0.2

119

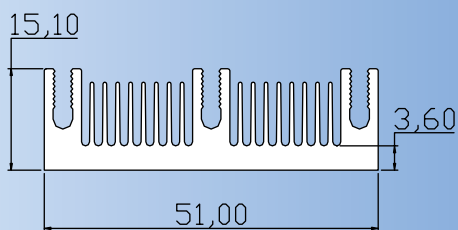

CS500-218-BA-00

Spec: 51.0*15.1*FREE±0.2

120

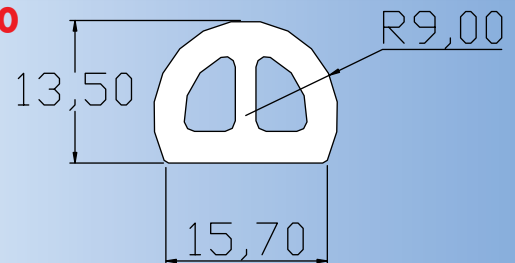

CS500-219-BA-00

Spec: 15.7*13.5*FREE±0.2

121

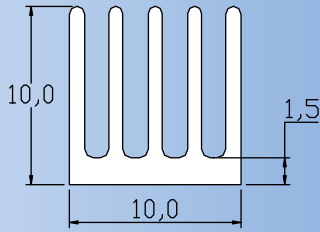

CS500-220-BA-00

Spec: 10.0*10.0*FREE±0.2

122

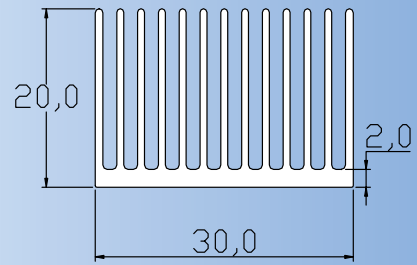

CS500-221-BA-00

Spec: 30.0*20.0*FREE±0.2

123

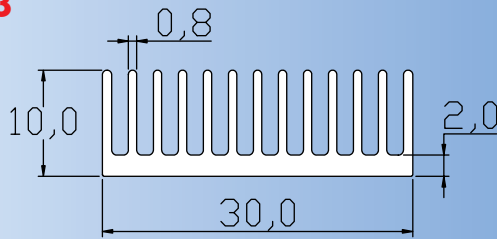

CS500-222-BA-00

Spec: 30.0*10.0*FREE±0.2

124

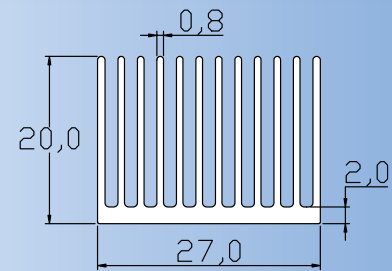

CS500-223-BA-00

Spec: 27.0*20.0*FREE±0.2

125

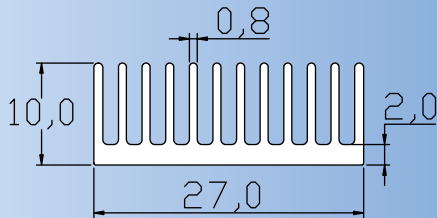

CS500-224-BA-00

Spec: 27.0*10.0*FREE±0.2

126

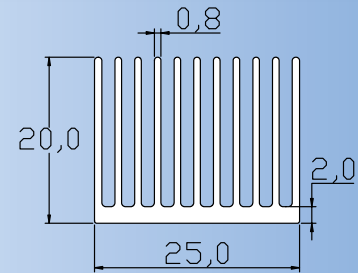

CS500-225-BA-00

Spec: 25.0*20.0*FREE±0.2

127

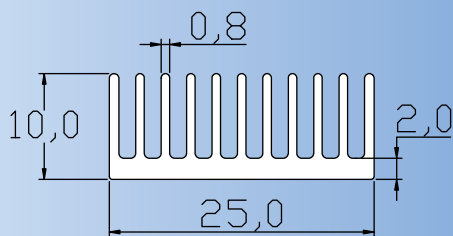

CS500-226-BA-00

Spec: 25.0*10.0*FREE±0.2

128

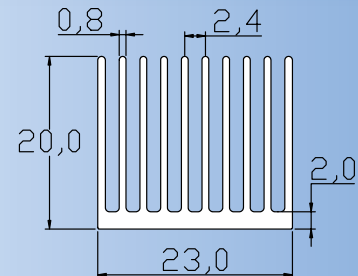

CS500-227-BA-00

Spec: 23.0*20.0*FREE±0.2

129

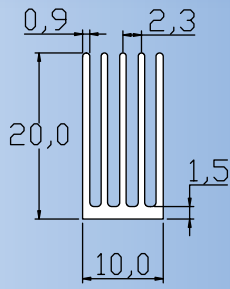

CS500-228-BA-00

Spec: 10.0*20.0*FREE±0.2

130

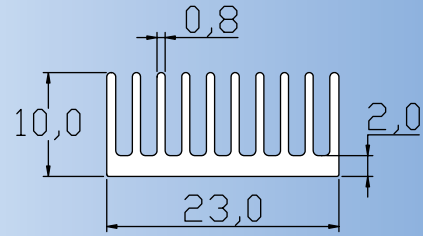

CS500-229-BA-00

Spec: 23.0*10.0*FREE±0.2

131

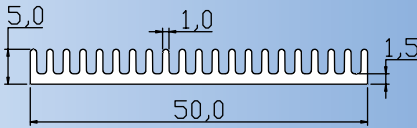

CS500-230-BA-00

Spec: 50.0*5.0*FREE±0.2

132

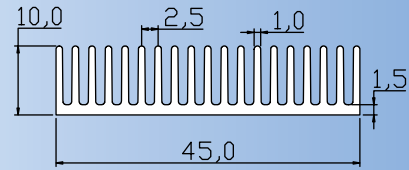

CS500-231-BA-00

Spec: 45.0*10.0*FREE±0.2

133

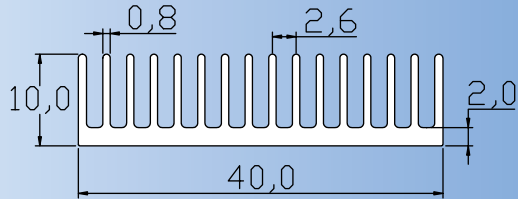

CS500-232-BA-00

Spec: 40.0*10.0*FREE±0.2

134

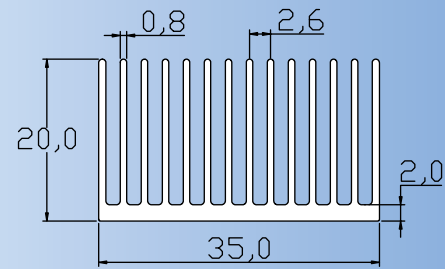

CS500-233-BA-00

Spec: 35.0*20.0*FREE±0.2

135

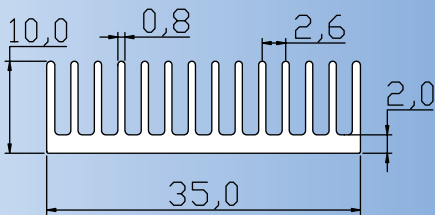

CS500-234-BA-00

Spec: 35.0*10.0*FREE±0.2

136

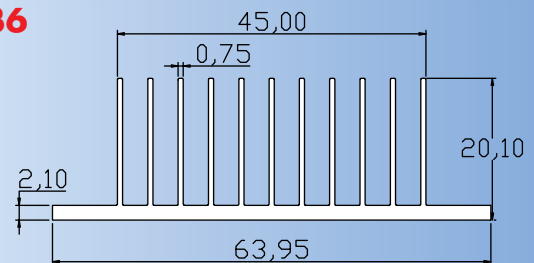

CS500-235-BA-00

Spec: 63.95*20.1*FREE±0.2

137

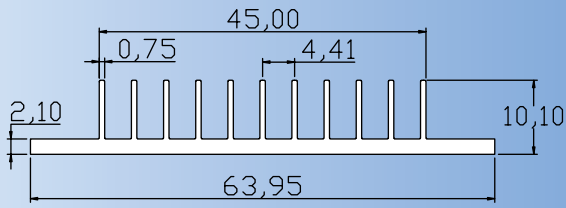

CS500-236-BA-00

Spec: 63.95*10.1*FREE±0.2

138

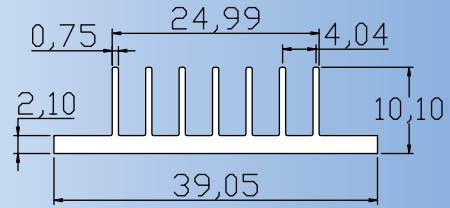

CS500-237-BA-00

Spec: 39.05*10.1*FREE±0.2

139

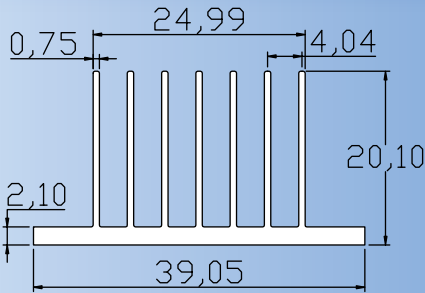

CS500-238-BA-00

Spec: 39.05*20.1*FREE±0.2

140

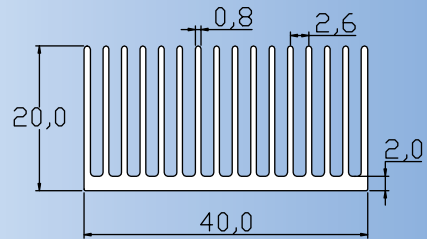

CS500-239-BA-00

Spec: 40.0*20.0*FREE±0.2

141

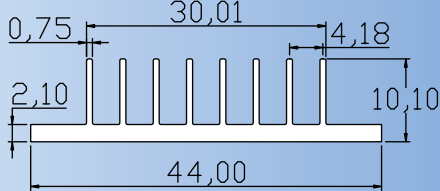

CS500-240-BA-00

Spec: 44.0*10.1*FREE±0.2

142

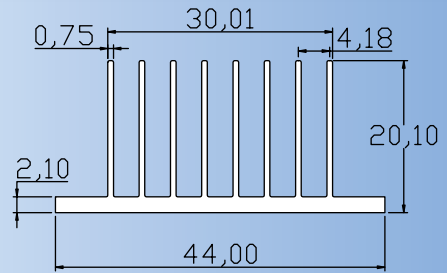

CS500-241-BA-00

Spec: 44.0*20.1*FREE±0.2

143

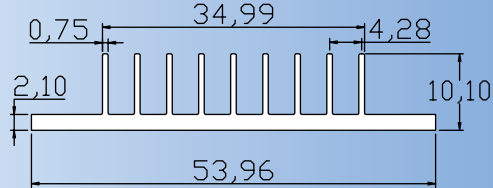

CS500-242-BA-00

Spec: 53.96*10.1*FREE±0.2

144

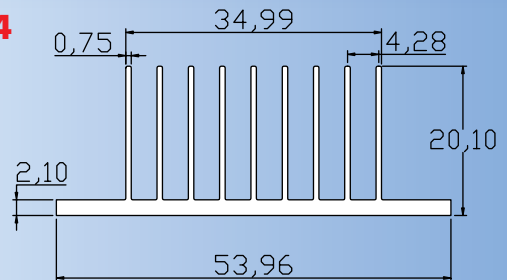

CS500-243-BA-00

Spec: 53.96*20.1*FREE±0.2

145

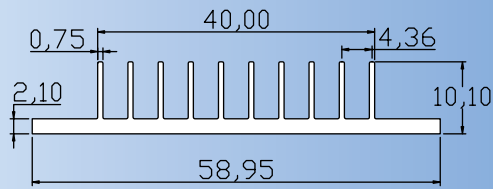

CS500-244-BA-00

Spec: 58.95*10.1*FREE±0.2

146

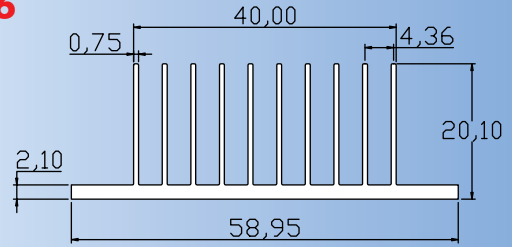

CS500-245-BA-00

Spec: 58.95*20.1*FREE±0.2

147

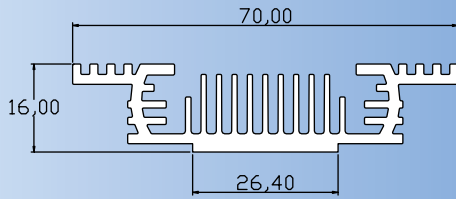

CS500-246-BA-00

Spec: 70.0*16.0*FREE±0.2

148

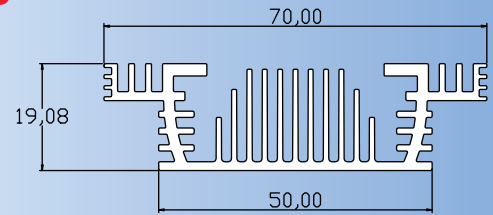

CS500-247-BA-00

Spec: 70.0*19.08*FREE±0.2

149

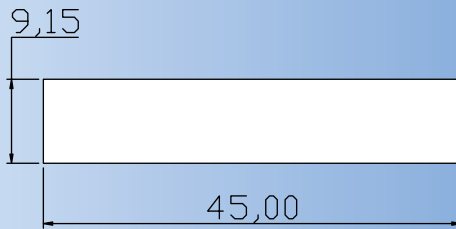

CS500-248-BA-00

Spec: 45.0*9.15*FREE±0.2

150

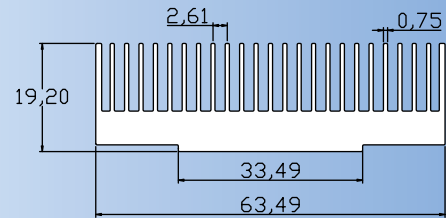

CS500-249-BA-00

Spec: 63.49*19.2*FREE±0.2

151

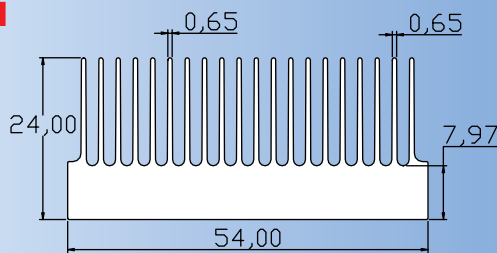

CS500-250-BA-00

Spec: 54.0*24.0*FREE±0.2

152

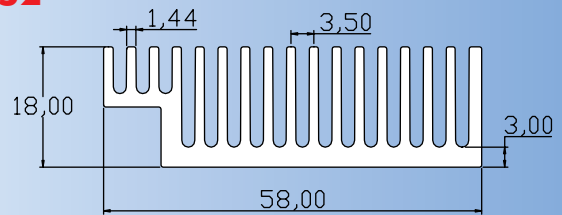

CS500-251-BA-00

Spec: 58.0*18.0*FREE±0.2

153

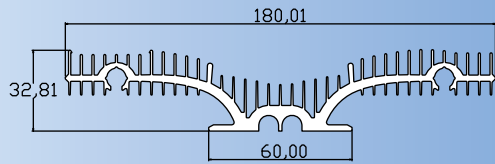

CS500-252-BA-00 Spec: 180.01*32.81*FREE±0.2

154

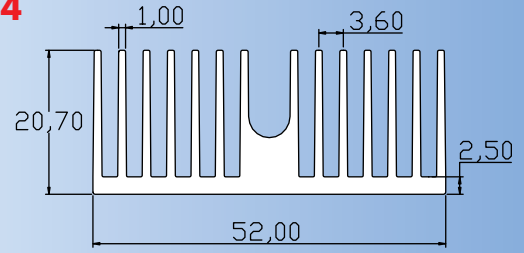

CS500-253-BA-00 Spec: 52.0*20.7*FREE±0.2

155

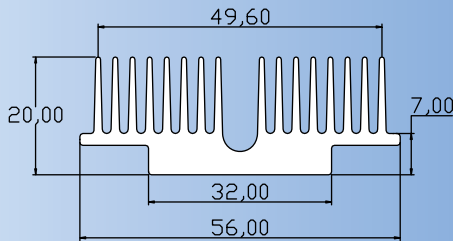

CS500-254-BA-00 Spec: 56.0*20.0*FREE±0.2

156

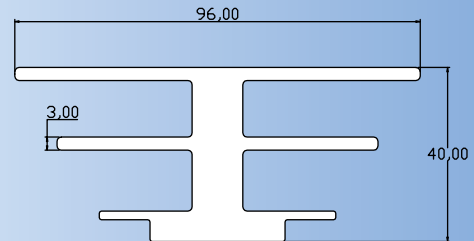

CS500-255-BA-00 Spec: 96.0*40.0*FREE±0.2

157

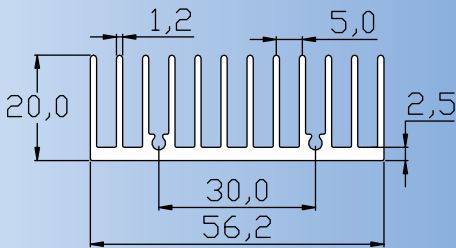

CS500-256-BA-00 Spec: 56.2*20.0*FREE±0.2

158

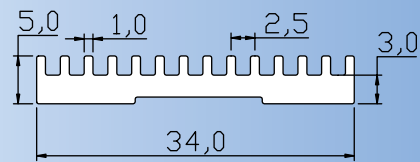

CS500-257-BA-00 Spec: 34.0*5.0*FREE±0.2

159

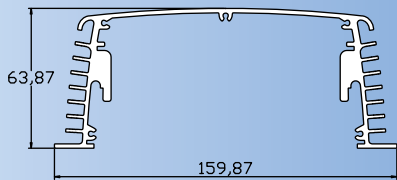

CS500-258-BA-00 Spec: 159.87*63.87*FREE±0.2

160

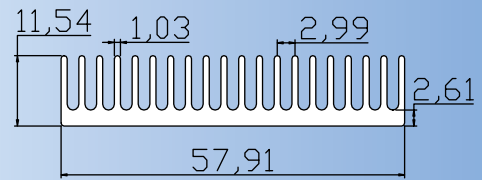

CS500-259-BA-00 Spec: 57.91*11.54*FREE±0.2

161

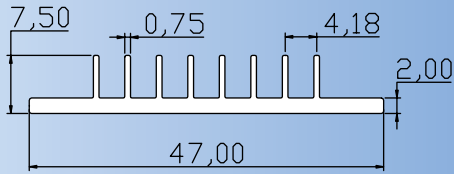

CS500-260-BA-00

Spec: 47.0*7.5*FREE±0.2

162

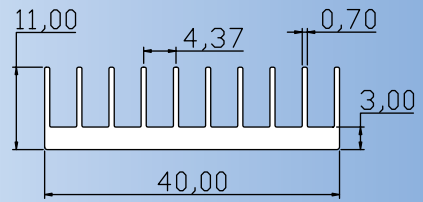

CS500-261-BA-00

Spec: 40.0*11.0*FREE±0.2

163

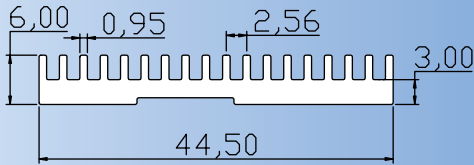

CS500-262-BA-00

Spec: 44.5*6.0*FREE±0.2

164

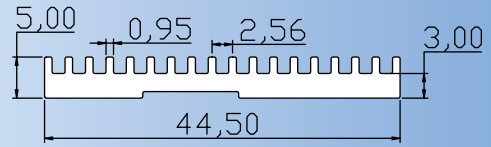

CS500-263-BA-00

Spec: 44.5*5.0*FREE±0.2

165

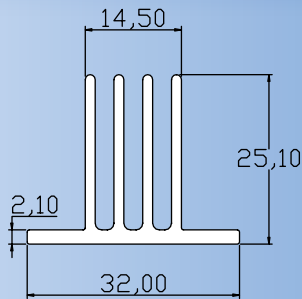

CS500-264-BA-00

Spec: 32.0*25.1*FREE±0.2

166

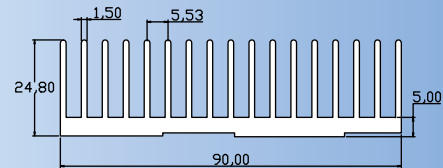

CS500-265-BA-00

Spec: 90.0*24.8*FREE±0.2

167

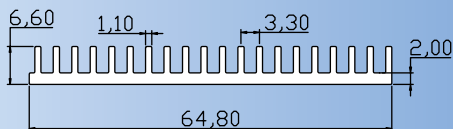

CS500-266-BA-00

Spec: 64.8*6.6*FREE±0.2

168

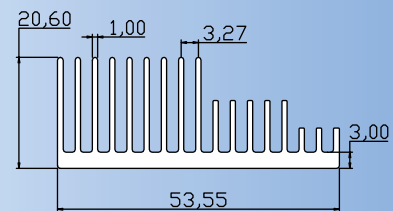

CS500-267-BA-00

Spec: 53.55*20.6*FREE±0.2

169

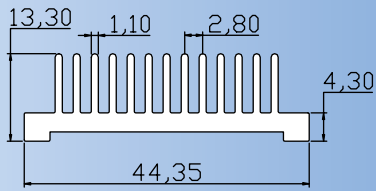

CS500-268-BA-00

Spec: 44.35*13.3*FREE±0.2

170

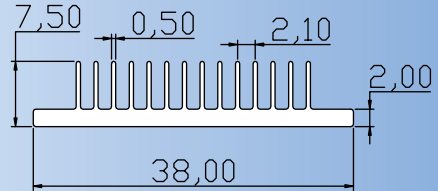

CS500-269-BA-00

Spec: 38.0*7.5*FREE±0.2

171

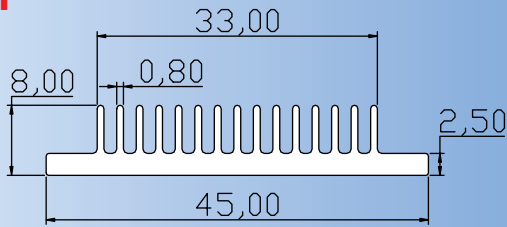

CS500-270-BA-00

Spec: 45.0*8.0*FREE±0.2

172

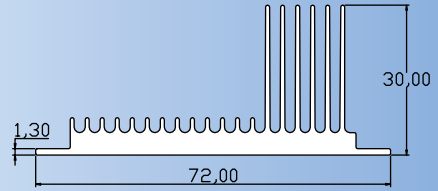

CS500-271-BA-00

Spec: 72.0*30.0*FREE±0.2

173

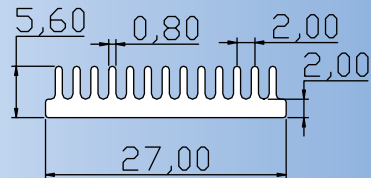

CS500-272-BA-00

Spec: 27.0*5.6*FREE±0.2

174

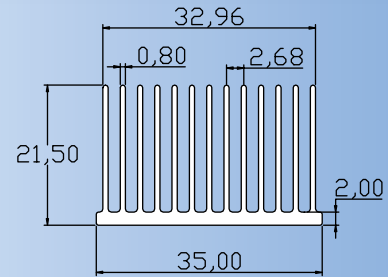

CS500-273-BA-00

Spec: 35.0*21.5*FREE±0.2

175

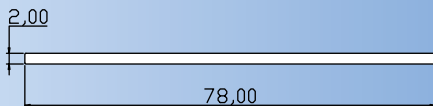

CS500-274-BA-00

Spec: 78.0*2.0*FREE±0.2

176

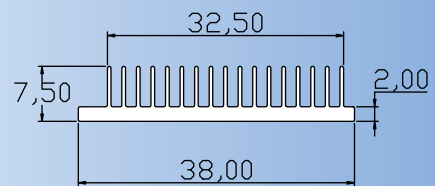

CS500-275-BA-00

Spec: 38.0*7.5*FREE±0.2

177

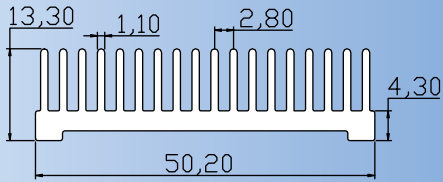

CS500-276-BA-00

Spec: 50.2*13.3*FREE±0.2

178

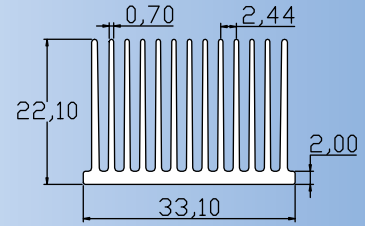

CS500-277-BA-00

Spec: 33.1*22.1*FREE±0.2

179

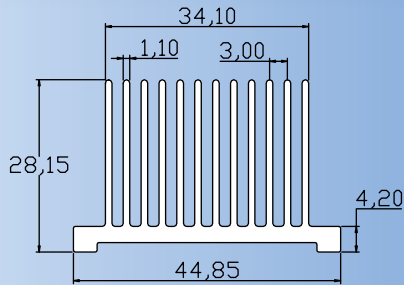

CS500-278-BA-00

Spec: 44.85*28.15*FREE±0.2

180

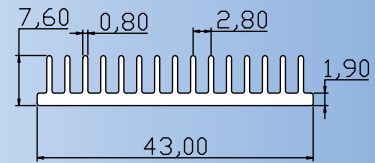

CS500-279-BA-00

Spec: 43.0*7.6*FREE±0.2

181

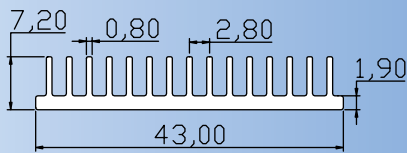

CS500-280-BA-00

Spec: 43.0*7.2*FREE±0.2

182

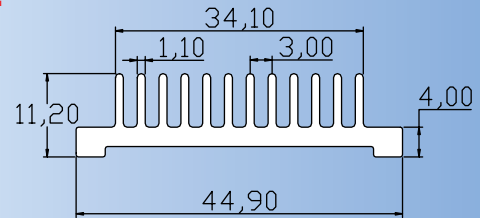

CS500-281-BA-00

Spec: 44.9*11.2*FREE±0.2

183

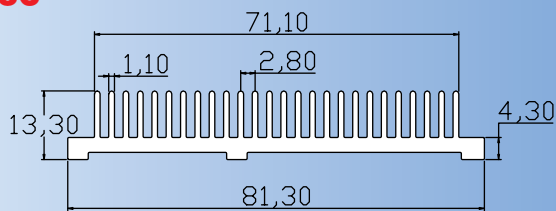

CS500-282-BA-00

Spec: 81.3*13.3*FREE±0.2

184

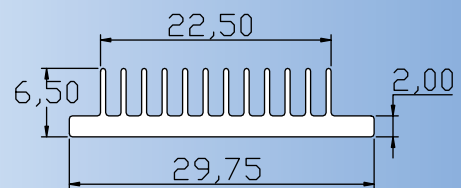

CS500-283-BA-00

Spec: 29.75*6.5*FREE±0.2

185

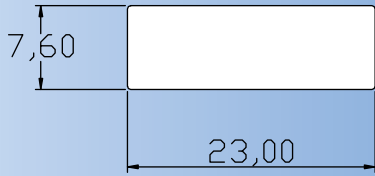

CS500-284-BA-00

Spec: 23.0*7.6*FREE±0.2

186

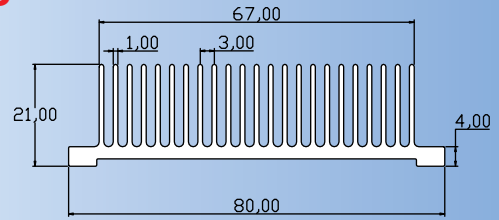

CS500-285-BA-00

Spec: 80.0*21.0*FREE±0.2

187

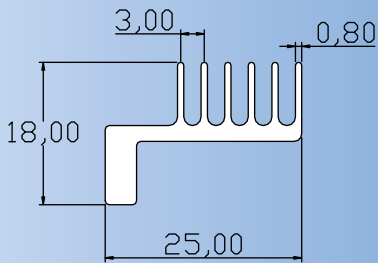

CS500-286-BA-00

Spec: 25.0*18.0*FREE±0.2

188

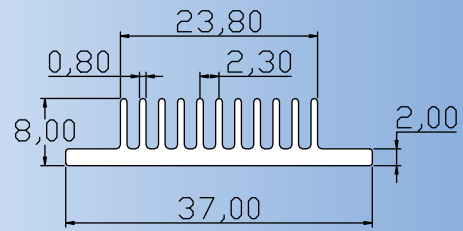

CS500-287-BA-00

Spec: 37.0*8.0*FREE±0.2

189

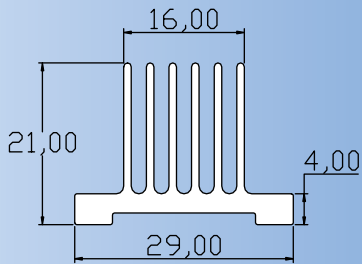

CS500-288-BA-00

Spec: 29.0*21.0*FREE±0.2

190

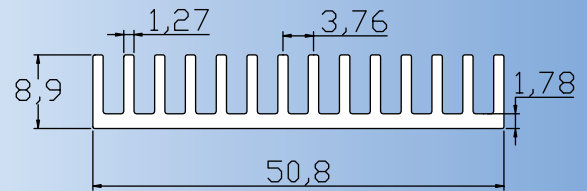

CS500-289-BA-00

Spec: 50.8*8.9*FREE±0.2

191

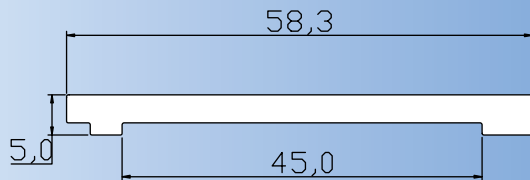

CS500-290-BA-00

Spec: 58.3*5.0*FREE±0.2

192

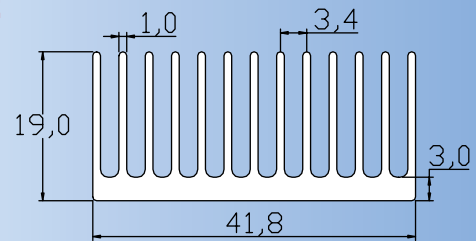

CS500-291-BA-00

Spec: 41.8*19.0*FREE±0.2

193

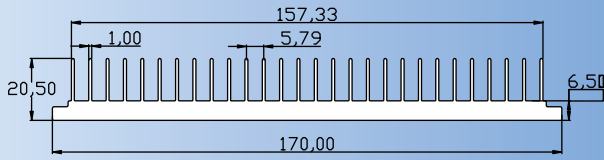

CS500-292-BA-00

Spec: 170.0*20.5*FREE±0.2

194

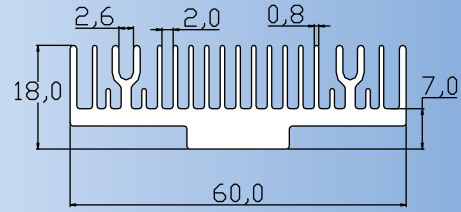

CS500-293-BA-00

Spec: 60.0*18.0*FREE±0.2

195

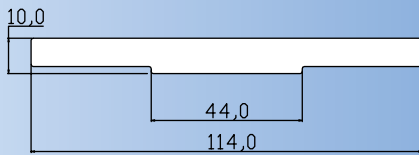

CS500-294-BA-00

Spec: 114.0*10.0*FREE±0.2

196

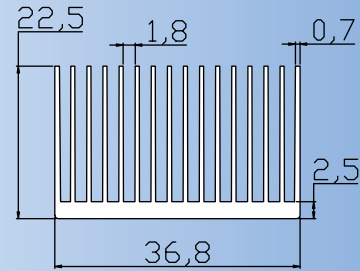

CS500-295-BA-00

Spec: 36.8*22.5*FREE±0.2

197

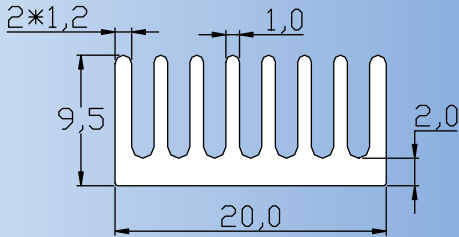

CS500-296-BA-00

Spec: 20.0*9.5*FREE±0.2

198

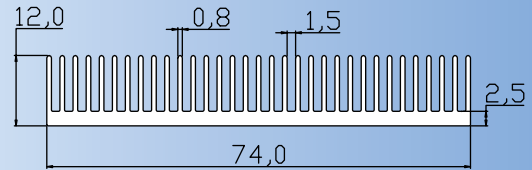

CS500-297-BA-00

Spec: 74.0*12.0*FREE±0.2

199

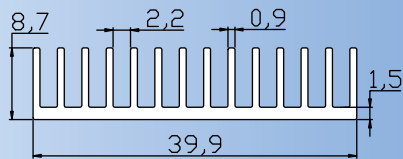

CS500-298-BA-00

Spec: 39.9*8.7*FREE±0.2

200

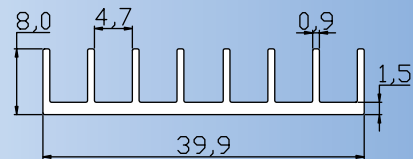

CS500-299-BA-00

Spec: 39.9*8.0*FREE±0.2

201

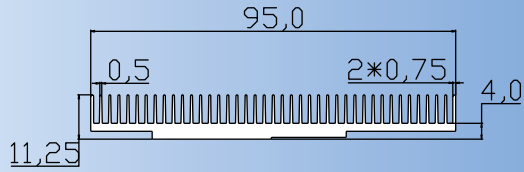

CS500-300-BA-00

Spec: 95.0*11.25*FREE±0.2

202

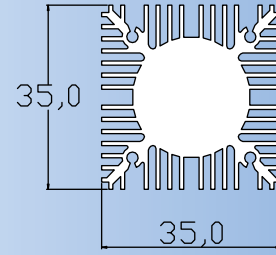

CS500-301-BA-00

Spec: 35.0*35.0*FREE±0.2

203

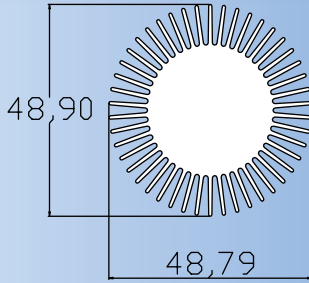

CS500-302-BA-00

Spec: 48.79*48.9*FREE±0.2

204

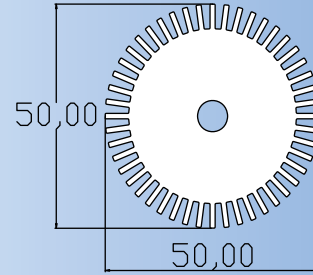

CS500-303-BA-00

Spec: 50.0*50.0*FREE±0.2

205

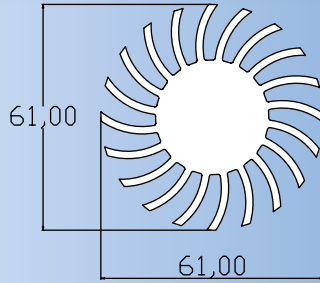

CS500-304-BA-00

Spec: 61.0*61.0*FREE±0.2

206

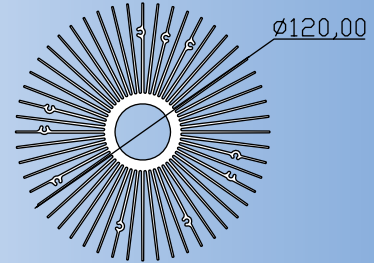

CS500-305-BA-00

Spec: Ø120.0*FREE±0.2



- *Bonded Fin Heat sink*
- *Stamped Fin*
- *Heat-pipe Assembly*
- *Precision Forging*
- *Die Casting*
- *Skived Fin*
- *Extrusion*

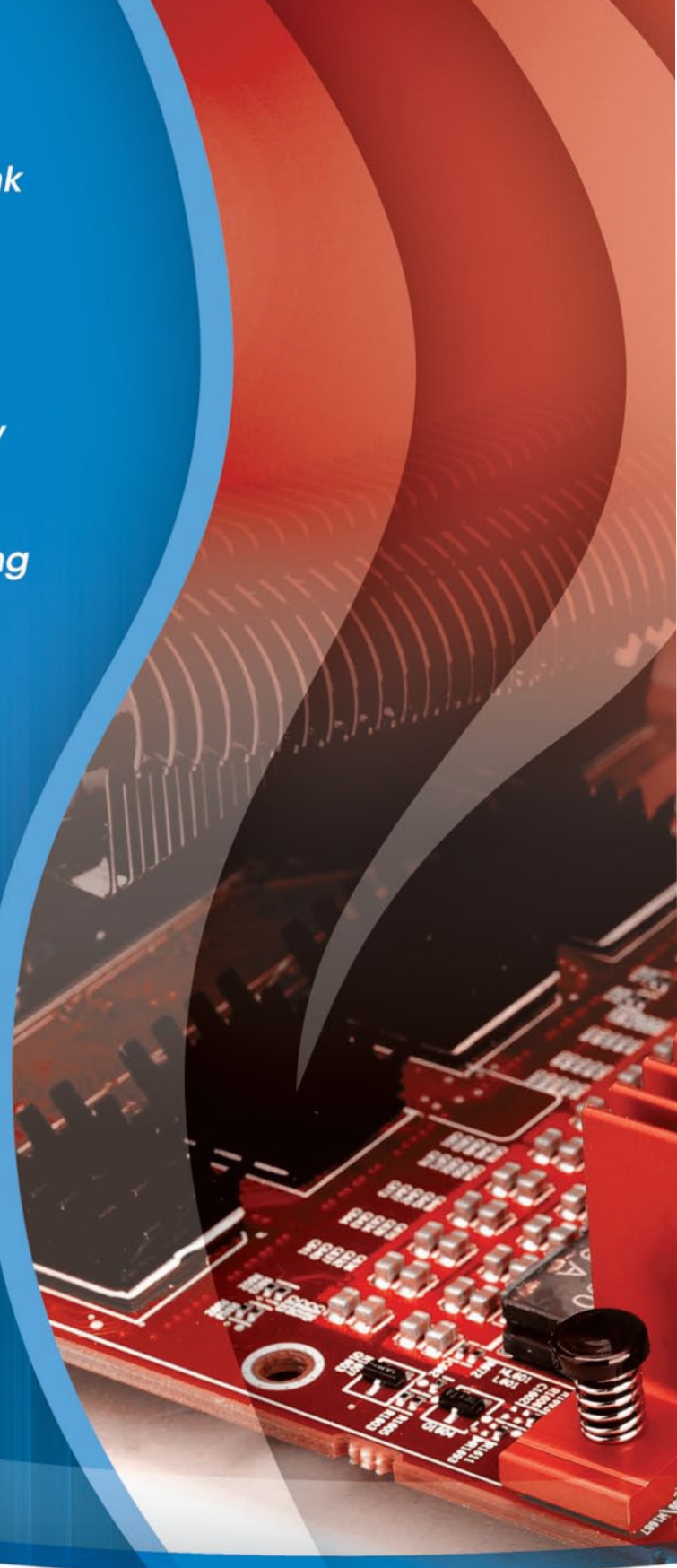

3111 Independence Dr.
Livermore, CA 94551

Tel: 888-509-2665
Tel: 925.292.1293
Fax: 925.292.5061

www.coolingsource.com