



 **Kendeil™**  
Aluminium  
Electrolytic  
Capacitors



# OVERVIEW

## COMPANY PRESENTATION

Product Road Map	page n.
Part number system	3
Cap weight table	4
Quality	5
	6

## TECHNICAL INFORMATION

Building an electrolytic capacitor	7
Electrical Characteristics	9
Reliability	12
Useful life	13
Guidelines for aluminium electrolytic capacitors	14
Manufacturing control flow	18

## CAPACITORS

All sections include specifications and standard ratings

### *Screw Capacitors*

K01 type Compact	85°C	15000H	19
K02 type Professional	105°C	5000H	29
K03 type Heavy discharge	70°C		37
K04 type Professional	85°C	20000H	40
K07 type Compact	85°C	2000H	45
K11 type Bulk application	85°C	15000H	51
K21 type High ripple application	85°C	15000H	54
K22 type High ripple application	105°C	5000H	58
K41 type Long Term Vibration Resistance	85°C	15000H	62
K42 type Long Term Vibration Resistance	105°C	5000H	71
K61 type Professional Audio Application	85°C	25000H	79
K71 type High miniaturization	85°C	15000H	82
K72 type High miniaturization	105°C	5000H	86
K91 type Low ESR	85°C	15000H	90
K92 type Low ESR	105°C	5000H	94

### *Snap-in Capacitors*

K05 type Professional	105°C	5000H	98
K06 type General Purpose	85°C	5000H	105
K15 type Professional	105°C	5000H	112
K16 type General Purpose	85°C	5000H	115
K25 type Low ESR Design	105°C	8000H	118
K26 type Low ESR Design	85°C	12000H	121
K55 type Solar Inverter Professional	105°C	6000H	124
K75 type High miniaturization	105°C	5000H	127
K76 type High miniaturization	85°C	5000H	132
K85 type Very Low ESR and Long Life	105°C	8000H	137
K95 type Low ESR	105°C	5000H	141

### *Motor Start Capacitors*

K13 type	145
----------	-----

## ACCESSORIES

Ring clips	148
Insulated hex nuts, washers	149
Mounting hardware	150
General warning	151
Distributors	152
Note	157

## COMPANY PRESENTATION

Kendeil is an Italian company with more than 35 years of experience in manufacturing high quality large can aluminium electrolytic capacitors.

Actual production range spreads from large can screw terminal type capacitors with high end performances to snap in terminal type capacitors mainly used on PCB boards, and to the motor start type for alternate current applications.

A continuous improvement in building technology and automatic computerized machines gives the company a leading role in the market of electronics components, along with competitive priced products and reliability performances. Also the flexibility of its structure is able to meet any custom design requirement.

All capacitors are international standards compliant CECC, DIN, IEC, under a Quality Certification ISO 9001 System.

Visit our website:  
[www.kendeil.com](http://www.kendeil.com)

# PRODUCT ROAD MAP

## Screw Terminals Type

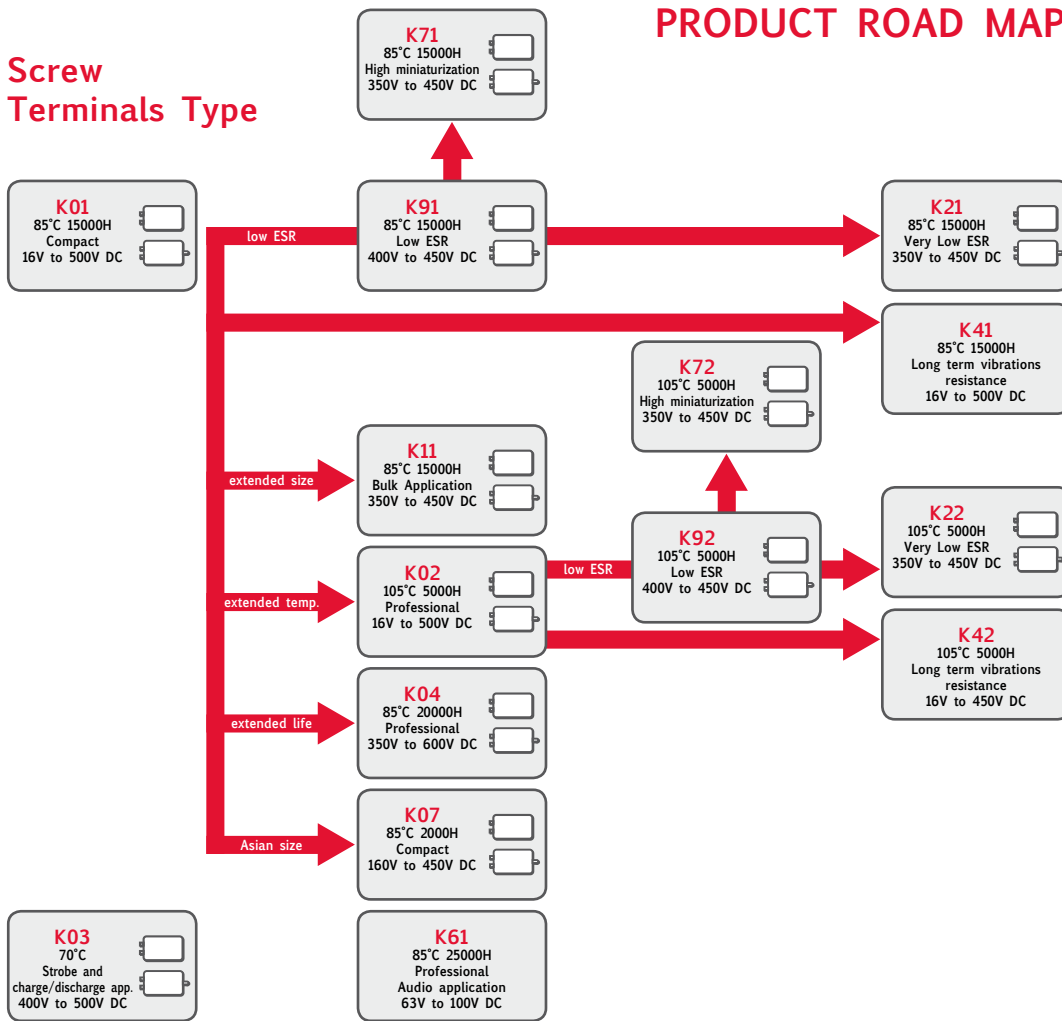

## Snap In Type

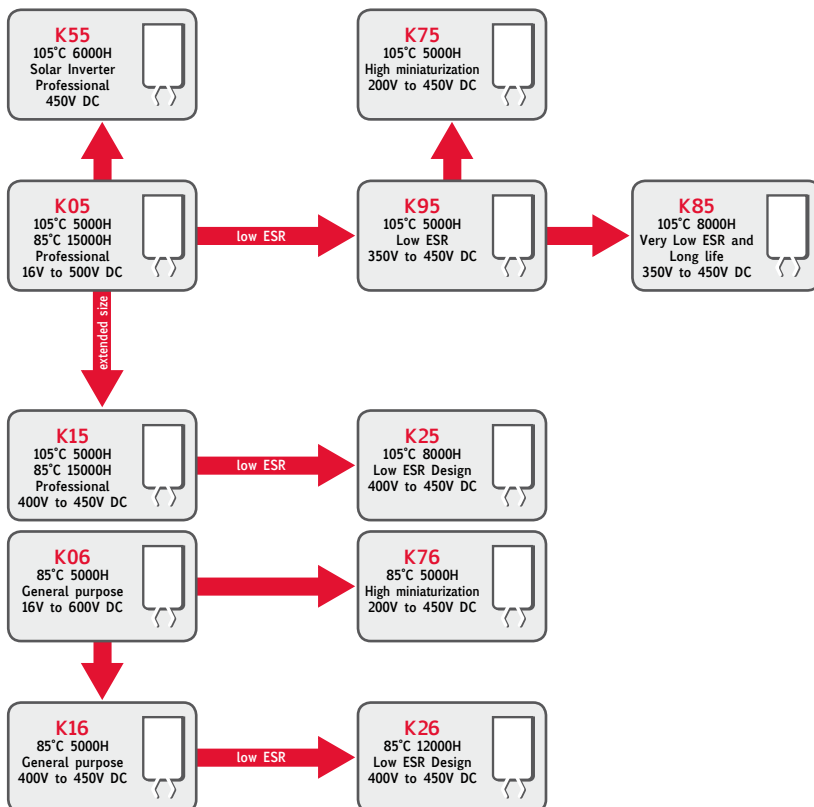

# PART NUMBER SYSTEM

New PART-NUMBER CODE in use since Sep 2010. Total length is 17 digits.  
Please see examples below and have a reference code from the standard ratings capacitors pages.

## SCREW AND SNAP IN CAPACITORS

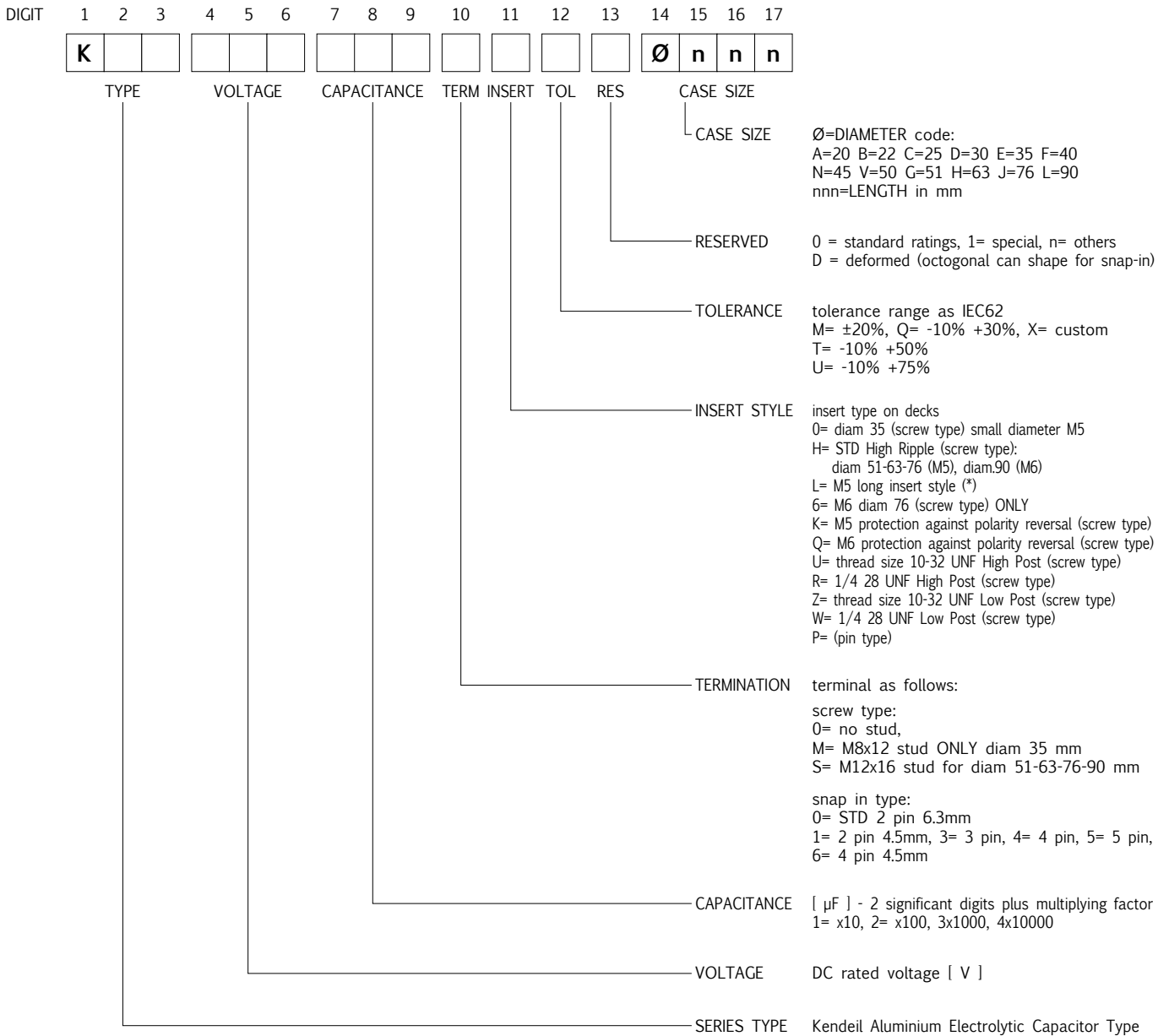

## EXAMPLES

K	0	1	1	0	0	2	2	3	0	H	M	0	H	1	0	5	K01 100V 22000µF, Hi ripple, -20%+20%, 63x105
K	0	1	0	6	3	2	2	3	S	H	Q	0	G	1	0	5	K01 63V 22000µF, stud M12x16, Hi rip. -10%+30%, 51x105
K	0	2	0	4	0	1	0	4	0	H	M	0	J	1	4	3	K02 40V 10000µF, Hi ripple, -20%+20%, 76x143
K	0	5	4	5	0	4	7	1	0	P	M	0	E	0	5	0	K05 450V 470µF, standard pin, ±20%, 35x50

Specifications subject to change without notice

(\*) Note for INSERT STYLE

M5 long insert style dedicated to not insulated bus bar  
(+2 mm height versus STD High Ripple code)

## CAP WEIGHT TABLE

SIZE ØxL [mm]	CASE CODE	APPROX UNIT WEIGHT grams	QTY/BOX pcs	BOX DIMENSIONS cm
35x51	E051	80	60	36 x 25 x 6
35x60	E060	70	60	36 x 25 x 8
35x79	E079	110	60	36 x 25 x 8
51x60	G060	110	42	38.5 x 38.5 x 14
51x79	G079	200	42	38.5 x 38.5 x 14
51x96	G096	252	42	38.5 x 38.5 x 14
51x105	G105	260	42	38.5 x 38.5 x 14
51x115	G115	270	42	38.5 x 38.5 x 20
51x130	G130	352	42	38.5 x 38.5 x 20
51x143	G143	370	42	38.5 x 38.5 x 20
63x60	H060	240	25	38.5 x 38.5 x 14
63x79	H079	280	25	38.5 x 38.5 x 14
63x96	H096	366	25	38.5 x 38.5 x 14
63x105	H105	420	25	38.5 x 38.5 x 14
63x115	H115	488	25	38.5 x 38.5 x 20
63x130	H130	527	25	38.5 x 38.5 x 20
63x143	H143	540	25	38.5 x 38.5 x 20
76x79	J079	450	16	38.5 x 38.5 x 14
76x105	J105	600	16	38.5 x 38.5 x 20
76x115	J115	616	16	38.5 x 38.5 x 20
76x130	J130	720	16	38.5 x 38.5 x 20
76x143	J143	940	16	38.5 x 38.5 x 20
76x214	J214	1540	8	37 x 26 x 26
90x145	L145	1250	6	37 x 26 x 26
90x220	L220	1790	6	37 x 26 x 26
90x240	L240	1880	6	37 x 26 x 26
22x25	B025	15	160	36 x 25 x 6
22x30	B030	19	160	36 x 25 x 6
22x40	B040	24	160	36 x 25 x 6
25x25	C025	16	126	36 x 25 x 6
25x30	C030	21	126	36 x 25 x 6
25x40	C040	30	126	36 x 25 x 6
25x50	C050	38	126	36 x 25 x 6
30x25	D025	24	88	36 x 25 x 6
30x30	D030	27	88	36 x 25 x 6
30x40	D040	38	88	36 x 25 x 6
30x50	D050	55	88	36 x 25 x 6
35x25	E025	42	60	36 x 25 x 6
35x30	E030	45	60	36 x 25 x 6
35x35	E035	50	60	36 x 25 x 6
35x40	E040	62	60	36 x 25 x 6
35x50	E050	78	60	36 x 25 x 6
35x60	E060	88	60	36 x 25 x 8
40x50	F050	98	48	36 x 25 x 6
40x60	F060	117	48	36 x 25 x 8
40x77	F077	138	48	36 x 25 x 8
40x97	F097	181	49	38.5 x 38.5 x 14
45x77	N077	200	49	38.5 x 38.5 x 14
45x97	N097	240	49	38.5 x 38.5 x 14
45x105	N105	260	49	38.5 x 38.5 x 14
50x60	V060	97	42	38.5 x 38.5 x 14
50x77	V077	180	42	38.5 x 38.5 x 14
50x105	V105	240	42	38.5 x 38.5 x 14

SCREW TYPE

SNAP-IN TYPE

NOTE: Only main products listed





# BUILDING AN ELECTROLYTIC CAPACITOR

## APPLICATIONS

A capacitor is an electrical component that stores a quantity of electrical charge defined with a linear relationship as:

$$Q = C \times V$$

where:  $Q$  = electrical charge [Coulomb]

$C$  = Capacitance [Farad]

$V$  = Voltage [Volt]

Usually values are indicated in a smaller unit called micro Farad [ $\mu\text{F}$ ] that is one million times smaller. An aluminium electrolytic capacitor is composed of one anode of aluminium foil (or one aluminium foil anode) having a dielectric oxidation on its surface, with semiconductor characteristics to prevent the current flow in one direction, and another aluminium foil cathode. There is also an electrolyte impregnated paper layer positioned between the anode and the cathode in order to avoid short circuits. Both the aluminium foils have been etched to obtain active surfaces, increasing their effective area. Aluminium tabs are then connected to the two foils to act as terminals. When in use the impregnated section is then closed inside an suitable case and sealed with a deck. The matching of thin dielectric and a large surface area allows to create capacitors with exceptional high capacitance per volume.

European (CECC) and International standards (IEC) have classified the capacitors in two categories. Electrolytic capacitors for high reliability applications (Long Life Grade): in addition of the possible over anodization (the difference between forming voltage and operating voltage) must generally satisfy high endurance requirements and a careful selection on materials is needed.

Such efforts are not required for capacitors standard version used for less severe reliability (General Purpose Grade).

The whole manufacturing process requested to build a Kendeil electrolytic capacitor could be reasonably split into the following phases:

- \* Etching
- \* Winding
- \* Impregnation
- \* Sealing
- \* Ageing
- \* Production Inspections

## ETCHING

Plates or electrodes are made of high purity, very thin aluminium foil (0.05 to 0.1 mm thickness). To get the maximum capacitance for a given electrode surface area, an electrochemical process called "etching" is used to dissolve metal and increase the surface area of the foil in the form of a dense network of microscopic channels.

The etching process consists of continuously running aluminium foil through a chloride solution with an AC, DC or AC/DC voltage applied between the etch solution and aluminium foil.

The increase in surface area is referred to as foil gain and can be increased as much as 100 times for foil being used in low voltage capacitor applications and 20 to 25 times for higher voltage applications. The dielectric of the aluminium electrolytic capacitor is composed of a thin layer of aluminium oxide ( $\text{Al}_2\text{O}_3$ ) which "forms" on the surface of the etched aluminium foil during a process called "formation."

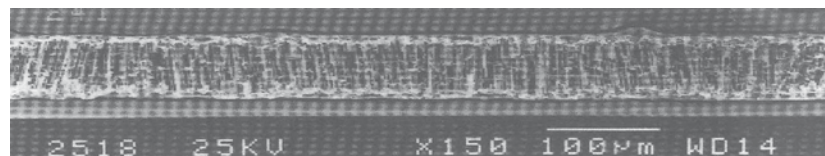

MICROGRAPHS VIEW OF ETCHED ALUMINIUM FOIL

Since capacitance is inversely proportional to the dielectric thickness and this is proportional to the forming voltage, the following relation is applicable:

$$\text{Capacitance} \times \text{Forming Voltage} = \text{Constant}$$

This is true for high voltage foils with a relatively coarse etch structure. However, for foils with extremely fine structures, the process to convert aluminium to aluminium oxide has a significant smoothing effect on the structure that might be described by a non-linear relationship.

## WINDING

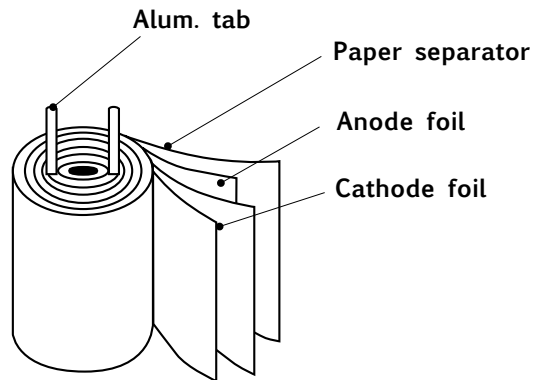

### THE CAPACITOR ELEMENT

Each capacitor contains two foils, the positive foil is called the ANODE and the negative is called the CATHODE. Both foils, along with a separator paper are rolled into a cylinder.

The separator paper prevents anode and cathode foils from coming into contact with each other and shorting. As part of a highly automated winding process, aluminium tabs are attached to the anode and cathode foils. This completed assembly of etched and formed foil, together with separator paper and attached tabs is called the capacitor ELEMENT.

## IMPREGNATION

The method of impregnation requires the winding element to be immersed into the electrolyte by either a vacuum/pressure cycle with or without applied heat or by simple absorption.

The electrolyte contains a solvent such as ethylene glycol and a solute such as ammonium borate.

Should the dielectric film be damaged, the presence of the electrolyte will allow the capacitor to heal itself by forming more oxide. By selecting different electrolytes, the capacitor characteristics such as operating temperature range, frequency response, shelf life and load life could be improved.

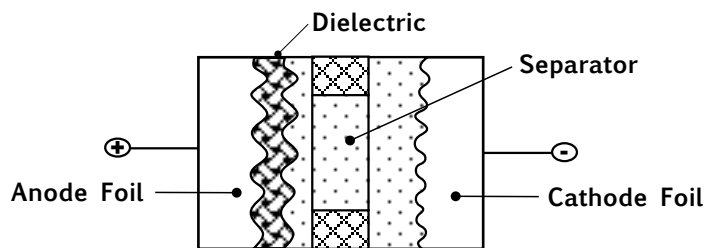

### The cross section for a typical element

## SEALING

After impregnation phase, the element is sealed into an aluminium can. Sealing deck materials may be rubber/bakelite or phenolic plastic.

## AGEING

Before being sleeved and packed the capacitor is aged and tested, this being the final process of the production chain, usually called "ageing". A voltage greater than the rated voltage is then applied at very high temperatures. The purpose is to reform or to repair any oxide film which may have been damaged during the slitting, winding and assembly processes, thus reducing the leakage current to an acceptable low level.

## PRODUCTION INSPECTIONS

After ageing, capacitors are 100% tested. All electrical requirements are checked using highly advanced automated test equipment and any rejects are removed. Capacitors are also visually inspected, and only capacitors passing both tests are accepted for packaging.

# ELECTRICAL CHARACTERISTICS

## RATED CAPACITANCE

The rated capacitance, defined at 100 Hz and 20°C, is the capacitance of an equivalent circuit having capacitance and resistance series connected. The value is indicated on the external sleeve, specified in micro Farads [μF]. Typical capacitance drift versus temperature and frequency, see below.

CAPACITANCE DRIFT VERSUS TEMPERATURE

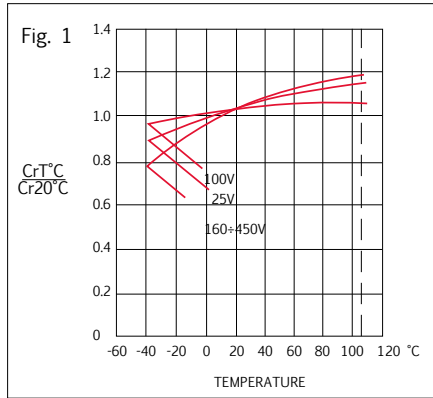

CAPACITANCE VERSUS FREQUENCY

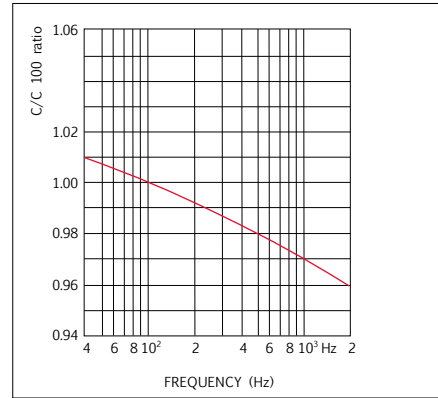

## RATED VOLTAGE ( $V_r$ )

The rated voltage is the value of voltage that could be applied continuously within the operating temperature range of capacitors. When using a capacitor with AC voltage superimposed on a DC voltage, care should be taken such that the peak value of AC voltage plus the DC voltage does not exceed the rated voltage.

Reverse polarization shall not exceed two times VDC value.

When capacitors are series connected, the voltage distribution across the series may not be the same. This is due to normal DC leakage distribution and should be considered in the design process either using a higher rated voltage capacitor or using balancing resistors in parallel with each series capacitor.

## SURGE VOLTAGE ( $V_p$ )

The surge voltage is the maximum overvoltage including DC, peak AC and transients to which the capacitor could be subjected for short periods of time (not more than 30 seconds in any 5 minute period).

Depending on applicable specifications, this test is usually performed at maximum operative temperature. A current limiting resistor of 1000 ohm should be used.

Charge is held for 30 seconds for 1000 cycles, then the capacitor is allowed to discharge without load for 5 minutes. Rated and surge voltage values for Kendeil capacitors are listed in following table, where a different relation is applied depending on rated value ( $V_r$ ).

	$V_p = 1.15 V_r$										$V_p = 1.10 V_r$			$V_p = 1.05 V_r$		
RATED VOLTAGE [V]	16	25	40	50	63	75	100	160	200	250	350	400	450	500	550	600
SURGE VOLTAGE [V]	18	29	46	57	72	86	115	184	230	287	385	440	495	525	578	630

## EQUIVALENT SERIES RESISTANCE ( ESR )

The equivalent series resistance is the resistance that a capacitor has to the alternating current flow. Various resistive components such as: electrolyte, paper foil, aluminium foil, tabs, and others determine the total ESR value. It is measured at 100 Hz and 20°C. It is related and dependant on temperature and frequency and generally when either these factors increase, a reduction in ESR results.

The construction technology of Kendeil capacitors reduces significantly the ESR value.

### Equivalent Standard Circuit

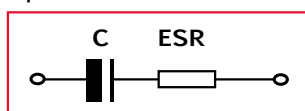

$$ESR = R_1 + R_2 + R_3$$

$R_1$  = Resistance of aluminium oxide thickness

$R_2$  = Resistance of electrolyte, spacer

$R_3$  = Resistance due to materials: foil length, tabs, terminations contact resistance

## LEAKAGE CURRENT (IL)

Measured at 20°C after 5 minutes under rated voltage.

It is the current flowing through the insulation resistance when a direct current is applied to the capacitor. After charging a capacitor to a set voltage we obtain, initially, a high current flow which decreases rapidly until a constant very small value is reached, the final leakage current. The leakage current value increases both with voltage and temperature. After a long storage period, the leakage current value can be exceeding the rated value and before the output measurement reanodization is necessary.

For typical leakage current versus time and temperature, see Fig. 2-3.

IL DRIFT VERSUS TIME

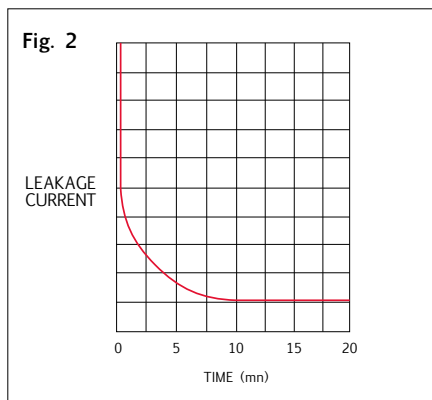

IL DRIFT VERSUS TEMPERATURE

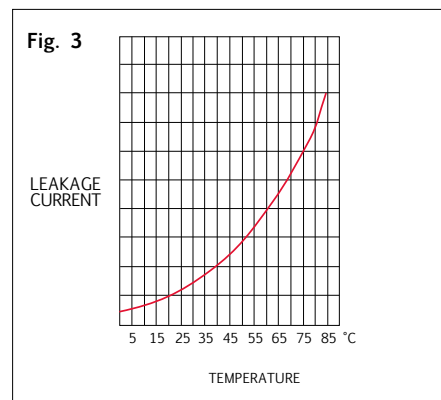

## DISSIPATION FACTOR (tan δ)

Dissipation factor or loss angle tangent (tan δ) is a main electrical characteristic of an electrolyte capacitor, a measure of the deviation from an ideal capacitance value.

Relationship is included in the following formula:

$$\tan \delta = 2 \pi f C ESR$$

where f = frequency      C= rated capacitance

Maximum values in the datasheets have been indicated at 100Hz and 20°C.  
Drift versus frequency as Fig. 4-5.

tg δ DRIFT VERSUS FREQUENCY  
LOW VOLTAGE (≤ 100 Vr d.c.)

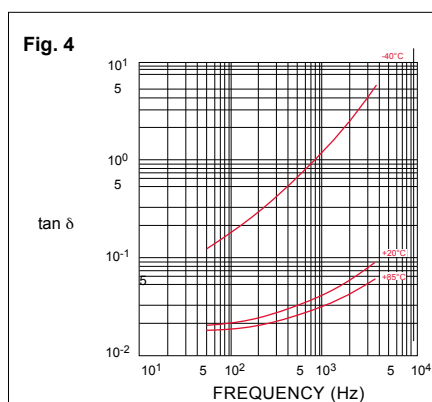

tg δ DRIFT VERSUS FREQUENCY  
HIGH VOLTAGE (> 100 Vr d.c.)

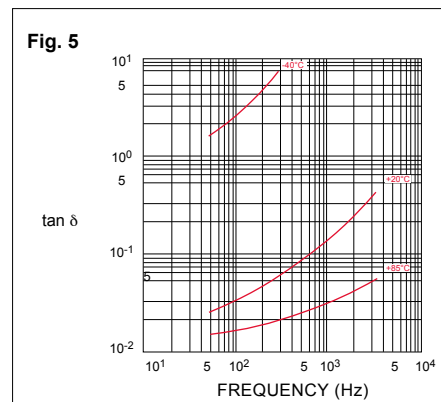

## INDUCTANCE

Some inductance is present in aluminium electrolytic capacitors, but values are usually less than few tens of nH.

## IMPEDANCE (Z)

$$Z = \sqrt{ESR^2 + (X_L - X_C)^2}$$

Impedance is dominated by the capacitive reactance ( $X_C$ ) at low frequencies and by the inductive reactance ( $X_L$ ) at high frequencies. At the point of series resonance  $Z=ESR$ . Typical impedance drift versus frequency, see Fig. 6-7.

**Z DRIFT VERSUS FREQUENCY  
HIGH VOLTAGE (> 100 V<sub>r</sub> d.c.)**

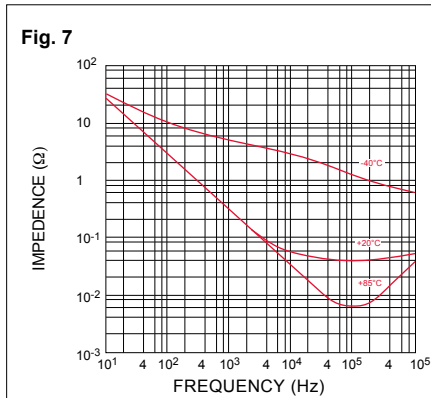

**Z DRIFT VERSUS FREQUENCY  
LOW VOLTAGE (≤ 100 V<sub>r</sub> d.c.)**

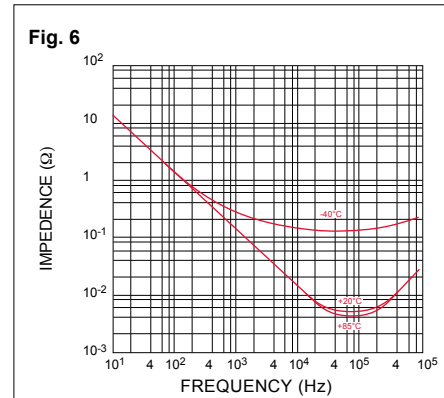

## RIPPLE CURRENT ( $I_r$ )

It is defined as the superimposed alternated ripple current (sinusoidal alternating current at 100 Hz). It depends mostly on an allowable temperature rise within a capacitor section due to the power relation formula:  $I^2 \times R$ . Heating occurs, due to an alternating current flowing through the equivalent series resistance of capacitor. Actual power must be considered when defining ripple current capability. The thermal gradient of an aluminium foil capacitor in an aluminium can is  $10^{-3}$  Watt/cm<sup>2</sup>/°C. Since the ripple current raises the temperature of the capacitor it has a significant effect on the operational life of the component. A diagram of useful life specifies life under given operating conditions of different temperatures values and ripple current values.

## SHELF LIFE (Voltage free storage)

Capacitors generally can be stored at temperatures up to 50°C without any reduction of their reliability. Overall characteristics such as capacitance, ESR and impedance should show good performance with no sensitive changes while the leakage current will exhibit a slow drift upwards.

In practical use, we experienced the following scheme meaningful for voltage rated classes of capacitors:

THREE YEARS	TWO YEARS
≤ 100V DC	> 100V DC

After an extended storage period, the leakage current value may exceed the rated value and, before the output measurement, a reanodization process is required.

It could be realized by applying the rated voltage at room temperature for one hour.

In any case it is advisable to use a maximum charging current of 5mA or twice typical value specified for each series.

With the advancements in aluminium electrolytic capacitor technology, the capacitors used in equipments must have a very long life characteristics and must operate even under severe conditions. A careful choice of a capacitor for a particular application and an adequate installation in the circuit will assure a good service life. In any case any component will eventually fail, usually this occurs due to a slow, steady drift of parameters called wear-out; sometimes there is a sharp change in capacitor properties also called catastrophic failure. In general terms the failure rate of aluminium electrolytic capacitors follows a bathtub curve with time as shown here.

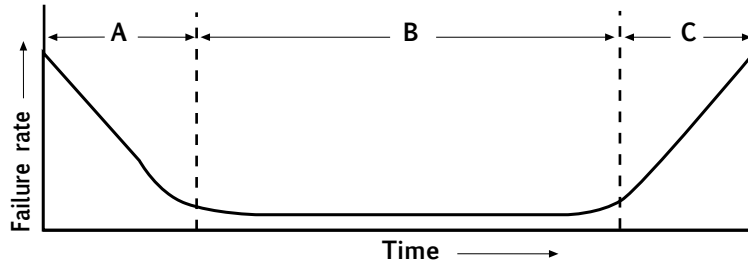

**THE BATHTUB CURVE**  
Three different areas are defined where capacitor life could be observed: A, B, C.

### (A) Initial Failure Period

This is the period during which failures are caused by deficiencies in design, structure, manufacturing processes or severe applications. Such failures occur soon after the components are exposed to circuit conditions. In aluminium electrolytic capacitors, these failures are either corrected through aging or found during the 100% inspection processes and do not reach the field.

Initial failures due to a bad application of the capacitor such as inappropriate ambient conditions, over voltage, reverse voltage or excessive ripple current can be avoided with an adequate circuit design and careful installation.

### (B) Random Failure Period (USEFUL LIFE)

Here the failure rate is low. During this period a constant failure rate is shown. These failures are not related to operating time but to application conditions. This period of useful life is normally calculated with a confidence level of 60%.

### (C) Wear-Out Failure Period

In this period the properties of a component gradually deteriorate and the failure rate increases with time. Aluminium electrolytic capacitors end their useful life during this period. Criteria for judging failures varies with application design factors.

Reliability represents this measure of the expected failure rate during the useful life of the capacitor. Failure rate is defined as the number of components failing during a unit working time. It is expressed by following formula:

1 fit = 1  $10^{-9}$ /hours (failure in time) also indicated as percentage of failures in 1000 hours.

$$\lambda = \text{number of failures} / (\text{number of components tested} \times \text{working time})$$

MTBF (Mean Time Before Failure) could be calculated according to failure rate following the relationship:

$$\text{MTBF} = 1/\lambda$$

This value defines the failure frequency occurring on a large number of components inside an equipment, therefore is not suitable to predict failure on one single capacitor. Statistical calculations should be used instead. It is helpful as a design tool to determinate reliability features for components and complex systems.

### EXAMPLE

A batch of 10000 capacitor tested, for 40000 operating hours, finding 4 failures.  
 $\lambda = 4/10000 \times 1/40000 \text{ h} = 10 \text{ fit} = 0.001\% / 1000 \text{ hours}$

The failure rate calculation is derived from endurance tests at specified temperatures, taking into account all measurable and non-measurable defects arised. Kind of measurable defects are meant for each type of capacitor endurance test point. While non-measurable defects are meant to be open and short circuit, safety valve break or electrolyte leakage. Ripple current and ambient temperature contribute to the internal temperature rise of the capacitor, so affecting its useful life. In general, every 10°C reduction in temperature carries a multiplier factor of two times the life value.

The typical useful life represents a period of time until the end of life of the capacitor. The end is caused by different incidents (or different failure modes) such as the following:

### MECHANICAL FAILURES

operation of safety vent due to overpressure, splitting of PVC sleeve and damaged insulation, unusable terminals, external short circuiting of terminals due to spilling of electrolyte.

### OVER FAILURES

when a short or open circuit occurs.

### ELECTRICAL CHARACTERISTICS FAILURES

In a group of capacitors considered to have reached the end when 3% of them have failed, useful life is influenced by following failure criteria:

#### END OF LIFE CRITERIA (for $V \leq 100V$ DC and for capacitors with diameter $\leq 35$ mm)

- ESR > 3 times initial value
- impedance > 3 times initial value
- capacitance value change of greater than 30%
- leakage current over initial limit.

#### END OF LIFE CRITERIA (for $V \geq 160V$ DC and for capacitors with diameter $\geq 40$ mm)

- ESR > 1.75 times initial value
- impedance > 1.75 times initial value
- capacitance value change of greater than 15%
- leakage current over initial limit.

In some cases, it is possible that even larger values of the above indicated could be applied without leading to failure, but generally capacitors tested in the laboratory at Kendeil show standard behaviour around these limits.

Obviously, when operating at lower voltages together with moderate temperature as well as lower values of current, the final life expectation should be better.

When an adequate cooling system has been provided, the overall performance is substantially better and the life of the capacitor is improved.

In normal conditions, statistics are produced after extensive endurance tests compliant to standard specifications. Depending of the type of capacitor, endurance tests have been undertaken over different lengths of time using capacitors coming from production batches. Data is collected and results summarized, so we have generated wide information displayed graphically for each model, which can be seen on each product datasheet. The useful lifetime regarding the ambient temperature is given by following practical formula:

$$\text{USEFUL LIFETIME} = L_{OPMAX} \times 2^{(T_{max}+10-T_c) / 10}$$

Where:

USEFUL LIFETIME expressed in hours

$L_{OPMAX}$  = Lifetime at max rated operating temperature (eg.: 10000 hs at 85°C)

$T_{max}$  = Actual operating temperature of the capacitors (eg.: 85°C for K01 type)

$T_c$  = Temperature of the core = internal hot spot of the capacitor (°C)

#### Example:

For a capacitor that has an internal core temperature of 55,43 °C, at ambient temperature of 45 °C, the life, expected calculation gives the following:

$$\begin{aligned} \text{USERFUL LIFETIME} &= 10000 \times 2^{(85+10-55.43) / 10} \\ &= 10000 \times 2^{3.956} \\ &= 155194 \text{ hours} \end{aligned}$$

#### NOTE

Applicable temperature range is the temperature depending on the capacitor type characteristics, usually situated in the operating range of -40°C to +85°C or 105°C . Typically, each 10°C step carries a reduction factor of 2 times the lifetime value.

Useful life is also determined by ripple current.

It is advisable not to apply a ripple current exceeding the max ripple current allowed as this will shorten capacitor life and may result in opening of the vent or catastrophic failure.

It often happens that heating due to ripple current is even more severe than ambient temperature stress.

# GUIDELINES FOR ALUMINIUM ELECTROLYTIC CAPACITORS

- POLARITY
- CHARGE - DISCHARGE APPLICATIONS
- INSULATION
- OPERATING TEMPERATURE
- CLIMATIC CONDITIONS
- MECHANICAL STRESS
- SOLDERING
- CLEANING
- STORAGE
- SAFETY
- BALANCING RESISTORS
- FLAMMABILITY

## • POLARITY

In DC applications polarity is required; if polarity is reversed, the circuit life will be shortened or the capacitor may be damaged. Generally, an intermittent reverse voltage of 1V DC is allowed. If during operation, it is possible that polarity could be reversed or unknown, extensive use of a bipolar capacitor is required.

## • CHARGE - DISCHARGE APPLICATIONS

Kendeil aluminium electrolytic capacitors are suitable for circuits in which a charge and discharge cycle is requested. The frequent cycles due to a charge or discharge operation could take some drop of capacitance value. In general one million of switching with rated voltage one cycle for second a time constant of 0.1 carries an overall capacitance decrease less than 10%.

## • INSULATION

In general all aluminium electrolytic capacitors are covered with a PVC sleeve, that is also used for marking. The aluminium can is not insulated from the cathode, so when the internal element needs to be electrically insulated from the can, capacitors specially designed for insulation requirements should be used.

## • OPERATING TEMPERATURE

A capacitor should be chosen with a maximum specified temperature greater than the operating temperature of the application; this will increase the capacitor useful lifetime.

## • CLIMATIC CONDITIONS

All Kendeil capacitors maintain good behaviour under any climatic conditions when operating conditions are within the design specifications limits of each product type. Since each capacitor is hermetically sealed, the wet element inside impregnated with electrolyte will not be exposed to external conditions such as high pressure or vacuum. Furthermore, all electrical parameters such as impedance, leakage current, ESR and capacitance, will not be significantly changed by these external conditions.

Temperature range of **Kendeil** electrolytic capacitors (IEC 68-1):

Capacitor type	IEC 68-1 code	Temperature Range
K01-K04-K07-K11-K21-K41-K61 screw	GP	-40°C + 85°C
K02-K22-K42 screw	GM	-40°C + 105°C
K05-K15-K25-K55 snap in	GM	-40°C + 105°C
K06-K16-K26 snap in	GP	-40°C + 85°C
K13 fast on (lug)	HS	-25°C + 75°C

## AIR PRESSURE

When operating at low values of external air pressure, there could also be an increase in the pressure inside the case. When an external vacuum exists, the pressure inside the capacitor could rise up to 1 bar. In these circumstances the internal vapour loss becomes greater resulting in an overall reduction in expected life.

## ALTITUDE

When in extreme altitude situations, consideration must be given to the shortening of capacitor life due to the reduced air density, preventing heat from being adequately dissipated from the external surfaces of the capacitor leading to an increase in internal temperatures.



## • MECHANICAL STRESS

If excessive force is applied to terminations, they may break or their connections with the inside element may be badly affected. The distance between terminations holes on the circuit board should be the same as the spacing between terminations on the capacitor.

## SCREW TERMINAL

Excessive torque force applied in tightening the screws into terminals will result in stripping the threads and possibly increasing the contact resistance. On the other hand, if screws are not enough tightened enough, the high contact resistance will cause localized heating at terminals plus an early failure of the capacitor.

## SNAP IN

Improper insertion into the circuit boards may break the terminals or impair their electrical connections with the internal elements. When provided, blank terminals of a multi-terminal capacitor should be considered to be at the same potential as the electrolyte, or cathode, and should therefore be isolated from the circuit.

## APPLICATION OF TORQUE TO ALUMINIUM THREADS

Please note the max applicable torque strength to screw type capacitors:

With M5 insert screw torque = 2Nm

With M6 insert screw torque = 4Nm

Screw torque strength for stud M8 = 4Nm

Screw torque strength for stud M12 = 8Nm

## • SOLDERING

Incorrect soldering may shrink or break the capacitor sleeve. Please read the following information carefully.

- When soldering a printed circuit board (PCB), the soldering temperature should not be excessive while time taken should be short. Otherwise it could have adverse effects on the electrical characteristics and insulating sleeves.
- During the soldering process, the sleeve may melt or break if it gets in contact with circuit board traces. Try to avoid this problem and do not locate circuit board traces under capacitor body.
- The sleeves may be melted by solder which migrates up through terminations holes in the circuit board.
- When soldering adjacent components to the capacitor, preheated lead wires or terminals may tear the capacitor sleeve if they come in contact with it. Therefore, capacitors are to be mounted carefully so that adjacent components terminations do not come into contact, particularly when mounting on through-hole circuit boards. For snap-in type capacitors: our products are in line with IEC standard and it means a resistance to soldering heat defined for solder bath method 260°C 10 s.

## • CLEANING

Aluminium can be aggressively attacked by halide ions, particularly by chloride ions. Even small amounts of chloride ions inside the capacitor will cause corrosion which contributes to rapid capacitance drop and venting. Therefore, the prevention of chloride contamination is the most important check point for quality control in production. Solvent proof capacitors are required when chlorinated hydrocarbons are used for cleaning. If aluminium electrolytic capacitors without the solvent-proof construction are present on the circuit board, alcohol based solvents are recommended for cleaning.

In this case, solvents such as methanol, ethanol, propanol and isopropanol should be used. Normal tests show that any detrimental effect is eliminated. An alkaline detergent may damage the aluminium metal and marking. Aqueous cleaning methods in conjunction with saponification are commonly used. However it is advisable to dry immediately with hot air, which is best achieved at 85°C for few minutes.

## • STORAGE

After having a capacitor exposed to high temperatures such as direct sunlight or heating elements, the capacitor life may be adversely affected. Also when capacitors have been stored under humid conditions for a long period of time, humidity will cause terminals to oxidize. Therefore it is highly recommended they should be stored at room temperature, in a dry place, out of direct sunlight.

A voltage treatment process should be applied after some years storage period.

When capacitors have been stored above room temperature, the anode foil may react with the electrolyte causing increased leakage current values. Application of normal voltages to these capacitors may result in higher leakage current values, but in most cases, they will return to normal levels in short time.

However on occasion it is possible that a certain amount of gas will be generated which might cause the safety vent to open. Capacitors that have been stored for long time should be subjected to a voltage reforming process which will regenerate internal dielectric layers.

## • SAFETY

When an escape of electrolyte has occurred, wash the affected area with hot water. Use rubber gloves to avoid skin contact. Any contact with eyes should be immediately irrigated with water and medical advice is sought. Kendeil electrolyte blends do not contain materials currently listed as carcinogenic or mutagenic such as polychlorinated biphenyls (PCB) or dimethylformamide (DMF). No Butyrolactone used as solvent.

Under exposure to electrolyte skin could become dry. Other irritations or effects may be caused to the mucous membranes particularly eyes, where conjunctivitis may result.

• **BALANCING RESISTORS in series and parallel connections**

The following explanation is given for a typical connection scheme, when two capacitors have been connected in series, this is a brief approach answering to the question “How much could be the maximum voltage applied to a capacitor?”

If we have two capacitors of 400V rated with ±20% tolerance range each. Total voltage applied is 800V (V<sub>circuit</sub>), in the best situation each capacitor is well balanced. Anyway the maximum and minimum values due to the tolerance range is then put in the formula. It is easy to calculate the maximum exposing voltage to whom the minimum capacitor could be applied.

$$V_{\text{MINCAP}} = V_{\text{circuit}} \times (1+20\%) / (\text{MIN}_{\text{tolerance}} + \text{MAX}_{\text{tolerance}})$$

Using the values from example, we have:  $V_{\text{MINCAP}} = 800 \times 1.2 / (0.8 + 1.2) = 480\text{V}$   
 This is the real maximum voltage value applied to the capacitor in a serial connection. It is strongly recommended to use a resistor that would share the over-voltage.  
 In the practical field of designing these kind of circuits, we have found that a good balancing system could be obtained using the following formula in which only the capacitor value is required.  
 We assume that a current from 15 to 20 times the leakage current value would be flowing in the resistor, therefore a simple relationship could be applied:

$$\text{Balancing Resistor [k}\Omega\text{]} = 60,000 / \text{Capacitance [}\mu\text{F]}$$

The resistor should have very good characteristic, usually with tolerance range of ±5% but better tolerance range is preferred when dealing with high transients and a top level performance is required.  
 When designing high current applications, a parallel configuration should be preferred.

**PRACTICAL TABLE**

Capacitor	Balancing Resistor
470 μF	127 k Ω
680 μF	88 k Ω
1000 μF	60 k Ω
2200 μF	27 k Ω
4700 μF	13 k Ω
6800 μF	9 k Ω
10000 μF	6 k Ω

**CONFIGURATION SCHEMES**

Two ways of connecting balancing resistors are implemented in the industry, depending on design and experience. Both of them have important features that must be borne in mind for the appropriate performances required.

**Single balancing resistor**

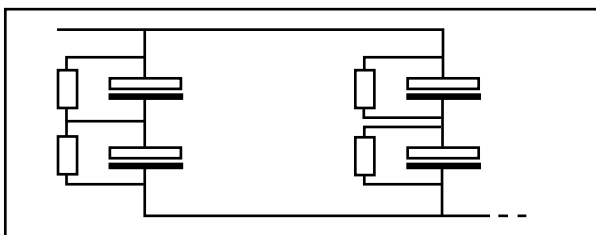

- (+) Plus features  
When one capacitor fails, the adjacent capacitor will probably fail too, but the other capacitor will remain undamaged.
- (-) Minus features  
There are many resistors to be placed in the circuit.

**Two parallel resistors**

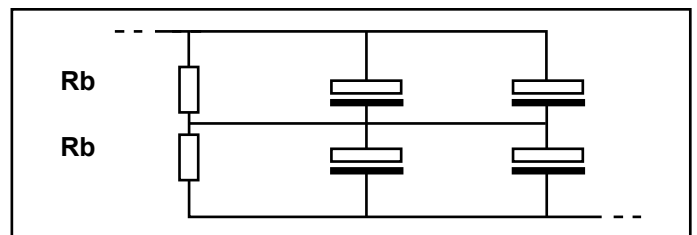

- (+) Plus features  
A better balancing system is achieved with “the most parallel capacitors used”.  
The total leakage current as the sum of the single branches components gives a very good balancing system. This configuration needs only two resistors and since the delta LC would be a very small value, it could be realized also without any resistor.
- (-) Minus features  
When one capacitor fails, the parallel branch in which it is operating will also fail as the total voltage will be applied under operating voltage conditions.

• **FLAMMABILITY**

Some component parts of a capacitor are suitable to burn depending on ambient temperature and adjacent elements, being made of plastic, PVC or other, even when classified as non flammable material.  
In the table you find the main materials with self extinguish capability under normal circumstances:

<b>PART</b>	<b>USE</b>	<b>MATERIAL</b>	
DECK	for screw type terminal for snap-in type terminal	Phenolic Rubber bakelite coupled	No ignition non flammable No ignition non flammable
CAN	for Motor Start type K13 ONLY	Polycarbonate (plastic)	Ignition not self extinguishing
SLEEVE	all screw snap-in type	PVC or PET	No ignition
VENT PLUG	for screw type terminal only	Silicone	Ignition non flammable
ELECTROLYTE	all internal wound elements in each capacitor	Glycol based (*)	not self extinguishing non flammable (*1) flash point 110°C higher then rated 85° or 105° class

(\*) NOTE FOR ELECTROLYTE

Kendeil uses glycol based electrolyte through all ranges of products.  
The impregnation process is computer controlled with supervisor agent software to assure the correct time and level of electrolyte needed by each single capacitor.  
Different kinds of electrolyte blends are being used, especially designed for low voltage, medium voltage and high voltage range.  
Each production batch is controlled in the internal laboratory to test the specifications of recipes.

<120V	120V - 400V	>400V
LOW VOLTAGE	MEDIUM VOLTAGE	HIGH VOLTAGE

(\*1) Flash point is defined as the lowest temperature at which a flame is ignited.  
In our case, no flammable behaviour is possible as the rated class of capacitors are under that value.

# MANUFACTURING CONTROL FLOW

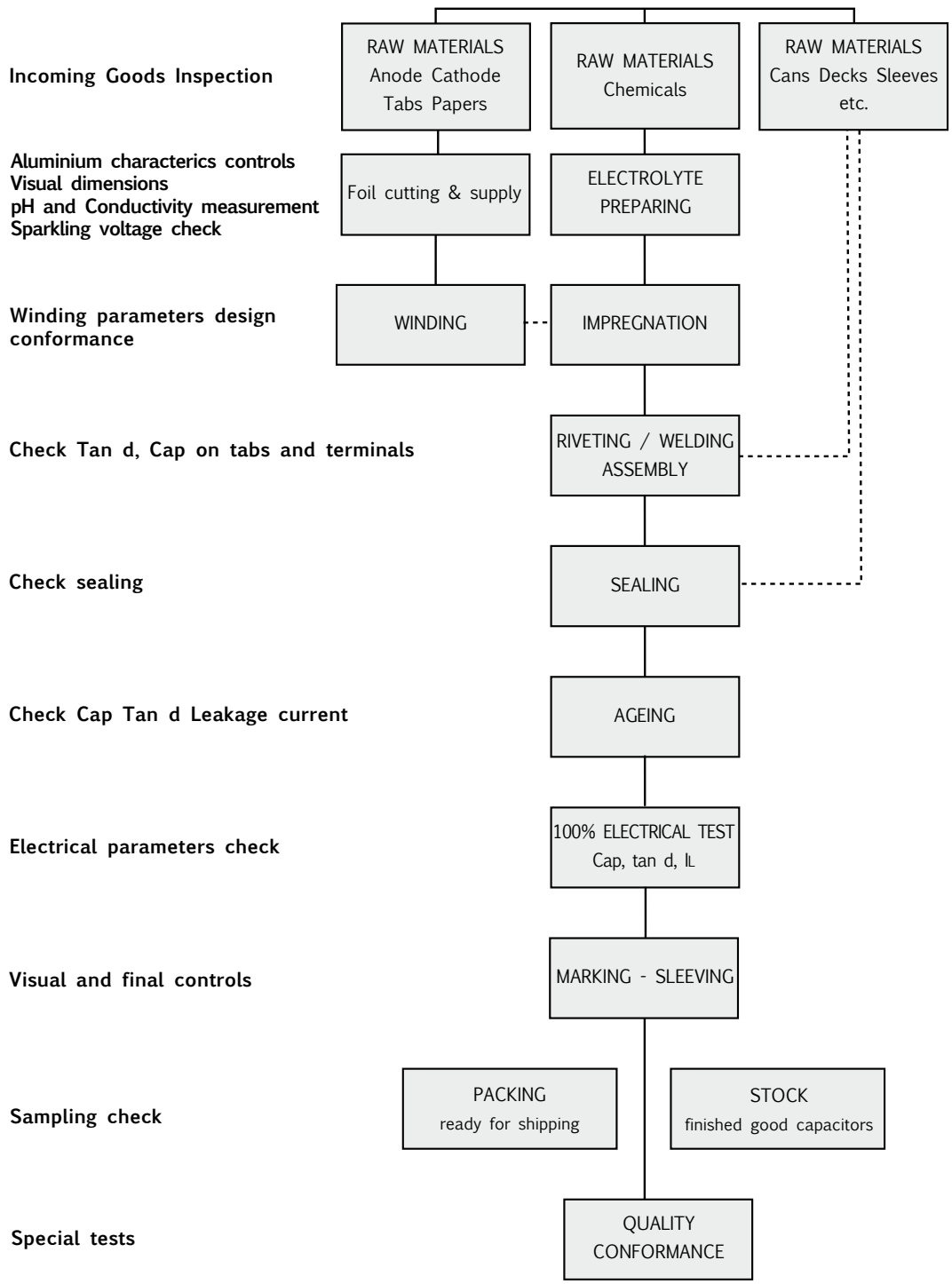

# K01 TYPE -40°C +85°C 15000H

RoHS Compliant

- Surge-proof capacitor in aluminium can with insulation sleeve.
- Poles brought out to heavy duty screw terminals.
- To be mounted with ring clips or with threaded stud
- Very high CV for unit volume with low ESR.
- High ripple current.
- Excellent electricals data in small dimensions case size.

## APPLICATIONS

Designed for professional power electronics. Switch mode power supplies, converters, filtering devices.

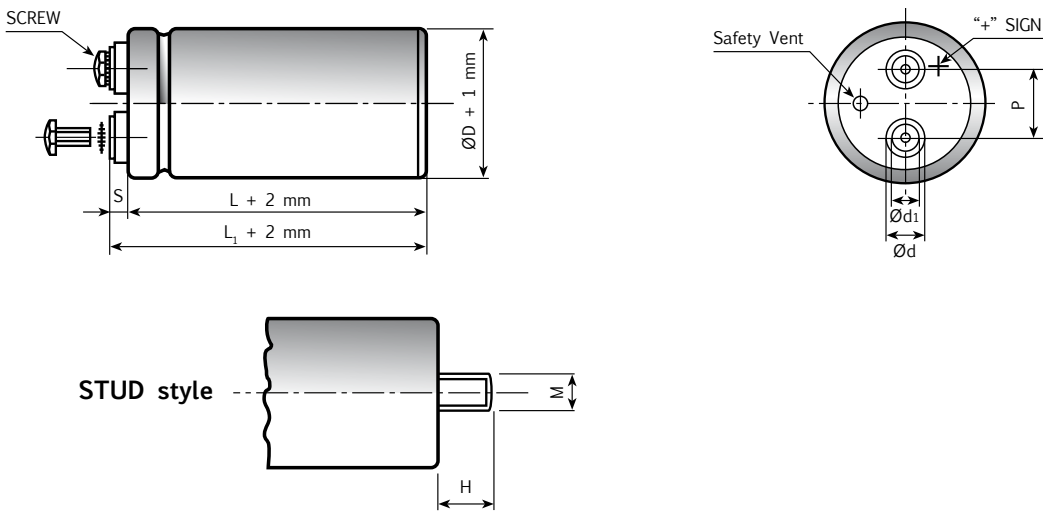

Diagram of dimensions (unit=mm)  
Insert and screw threads: Metric (mm), UNF (inches)

ØD	d	d1	P	STUD		INSERT	SCREW	L1	-L[-1+3]	S[-1+1]	INSERT STYLE CODE
				M	H						
35	11	7.9	12.7	M8	12	M5	5MA x 9.5	2.5	5	5	O
51	18.5	13	22.7	M12	16	M5	5MA x 9.5	2.5	5	5	H
63	18.5	13	28.6	M12	16	M5	5MA x 9.5	2.5	5	5	H
63	17.3	17.3	28.6	M12	16	UNF 1/4-28 Low Post	1/4-28 x 3/8"	3	4	4	W
63	17.3	17.3	28.6	M12	16	UNF 1/4-28 High Post	1/4-28 x 1/2"	6	7	7	R
63	7.9	7.9	28.6	M12	16	UNF 10-32 Low Post	10-32 x 1/4"	2	2.5	2.5	Z
63	12	7.9	28.6	M12	16	UNF 10-32 High Post	10-32 x 3/8"	6	7	7	U
76	18.5	13	31.8	M12	16	M5	5MA x 9.5	2.5	5	5	H
76	18.5	13	31.8	M12	16	M5	5MA x 9.5	2.5	7	7	L
76	23.2	17.7	31.8	M12	16	M6	6MA x 10	4.5	7	7	6
76	17.3	17.3	31.8	M12	16	UNF 1/4-28 Low Post	1/4-28 x 3/8"	3	4	4	W
76	17.3	17.3	31.8	M12	16	UNF 1/4-28 High Post	1/4-28 x 1/2"	6	7	7	R
76	7.9	7.9	31.8	M12	16	UNF 10-32 Low Post	10-32 x 1/4"	2	2.5	2.5	Z
76	12	7.9	31.8	M12	16	UNF 10-32 High Post	10-32 x 3/8"	6	7	7	U
90	23.2	17.7	31.8	M12	16	M6	6MA x 10	4.5	7	7	H

## SPECIFICATIONS

<b>Temperature Range</b>	Operating: -40°C +85°C Storage : Preferably below +25°C, not exceeding +40°C	[Environmental classification 40/85/56 IEC-68]																																										
<b>Rated Voltage Range (V<sub>r</sub>)</b>	from 16V to 500V DC																																											
<b>Surge Voltage (V<sub>p</sub>)</b>	V <sub>p</sub> = 1.05 V <sub>r</sub> (V <sub>r</sub> > 450V DC) V <sub>p</sub> = 1.15 V <sub>r</sub> (V <sub>r</sub> ≤ 250V DC) V <sub>p</sub> = 1.10 V <sub>r</sub> (V <sub>r</sub> > 250V DC)																																											
<b>Rated Capacitance Range</b>	from 220 µF to 1500000 µF																																											
<b>Capacitance Tolerance</b>	±20% at 100 Hz, 20°C [M class IEC-62] on request: -10% +30% at 100 Hz, 20°C [Q class IEC-62]																																											
<b>Leakage Current (I<sub>L</sub>)</b> (mA, 5 min, 20°C)	max I <sub>L</sub> = 0.006 C <sub>r</sub> V <sub>r</sub> + 4 µA At 85°C max I <sub>L</sub> = 0.04 C <sub>r</sub> V <sub>r</sub> µA	Kendeil product limit: I <sub>L</sub> = 0.003 C <sub>r</sub> V <sub>r</sub>																																										
<b>Ripple current (I<sub>r</sub>)</b>	Refer to table at 85°C and 100Hz. For different temperature and frequency multiplier must be used as follows:																																											
	<table style="width: 100%; border-collapse: collapse;"> <tr> <td style="text-align: left;">FREQUENCY</td> <td>50Hz</td> <td>100Hz</td> <td>500 Hz</td> <td>1000Hz</td> <td>&gt;10kHz</td> </tr> <tr> <td style="text-align: left;">MULTIPLIER</td> <td>0.8</td> <td>1.0</td> <td>1.2</td> <td>1.3</td> <td>1.5</td> </tr> <tr> <td colspan="6"> </td> </tr> <tr> <td style="text-align: left;">AMBIENT TEMP</td> <td>35°C</td> <td>45°C</td> <td>55°C</td> <td>65°C</td> <td>75°C</td> <td>85°C</td> <td>95°C</td> </tr> <tr> <td style="text-align: left;">MULTIPLIER</td> <td>2.2</td> <td>2.1</td> <td>1.8</td> <td>1.6</td> <td>1.4</td> <td>1.0</td> <td>0.5</td> </tr> <tr> <td style="text-align: left;">Maximum internal temperature</td> <td colspan="7">98°C</td> </tr> </table>		FREQUENCY	50Hz	100Hz	500 Hz	1000Hz	>10kHz	MULTIPLIER	0.8	1.0	1.2	1.3	1.5							AMBIENT TEMP	35°C	45°C	55°C	65°C	75°C	85°C	95°C	MULTIPLIER	2.2	2.1	1.8	1.6	1.4	1.0	0.5	Maximum internal temperature	98°C						
FREQUENCY	50Hz	100Hz	500 Hz	1000Hz	>10kHz																																							
MULTIPLIER	0.8	1.0	1.2	1.3	1.5																																							
AMBIENT TEMP	35°C	45°C	55°C	65°C	75°C	85°C	95°C																																					
MULTIPLIER	2.2	2.1	1.8	1.6	1.4	1.0	0.5																																					
Maximum internal temperature	98°C																																											
	Due to the current load capability of the contact elements, the following limits must not be exceeded:																																											
	<table style="width: 100%; border-collapse: collapse;"> <tr> <td style="text-align: left;">CAPACITOR DIAMETER</td> <td>35mm</td> <td>51mm</td> <td>63mm</td> <td>76mm</td> <td>90mm</td> </tr> <tr> <td style="text-align: left;">Maximum current</td> <td>20A</td> <td>30A</td> <td>40A</td> <td>50A</td> <td>70A</td> </tr> </table>		CAPACITOR DIAMETER	35mm	51mm	63mm	76mm	90mm	Maximum current	20A	30A	40A	50A	70A																														
CAPACITOR DIAMETER	35mm	51mm	63mm	76mm	90mm																																							
Maximum current	20A	30A	40A	50A	70A																																							
<b>Insulation Resistance</b>	At 100V DC for 1 min is >100 MΩ across insulating sleeve and terminals.																																											
<b>Vibration Resistance</b>	Frequency range: 10 Hz to 55 Hz, amplitude 0.75 mm Capacitor length ≤ 143 : max acceleration 10g for 3x2 h Capacitor length > 143 : max acceleration 5g for 3x0.5 h																																											
<b>Life test</b>	After 2,000 hours application of rated voltage at 85°C capacitors meet characteristics aside	Cap change ≤ 10% tan δ ≤ 130% Leakage current (I <sub>L</sub> ) < initial limit Impedance (Z) ≤ 130%																																										
<b>Shelf life</b>	After leaving capacitors under no load for 500 hours at 85°C, when restored at 20°C meet specifications aside	Cap change ≤ ±15% tan δ ≤ 150% Leakage current (I <sub>L</sub> ) < initial limit																																										
<b>Useful life</b> (V <sub>n</sub> , Temp rated I ripple applied)	> 200000 h at 40°C > 12000 h at 85°C for V <sub>r</sub> ≤ 100V and for V <sub>r</sub> ≥ 500V > 15000 h at 85°C for 100V < V <sub>r</sub> < 500V																																											
<b>Failure percentage</b> <b>Failure rate</b>	≤ 1% (during useful life) ≤ 25 fit (25 10 <sup>-9</sup> /h) (V <sub>r</sub> ≤ 160V DC) ≤ 33 fit (33 10 <sup>-9</sup> /h) (V <sub>r</sub> > 160V DC)																																											
<b>Self inductance</b>	Approx. 20 nH																																											
<b>Reference standards</b>	CECC 30.300 IEC 60384-4 LONG LIFE GRADE																																											

## K01 TYPE STANDARD RATINGS

Cap $\mu\text{F}$	$\varnothing \times L$ mm	Tan $\delta$ MAX 100 Hz 20°C	ESR TYP m $\Omega$ 100 Hz 20°C	Z TYP m $\Omega$ 10 kHz 20°C	Ir a.c. A max 100 Hz 85°C	PART NUMBER stud and insert style excluded
22000	35x60	0.35	18	16	6.6	K01016223__M0E060
33000	35x60	0.40	15	13	9.2	K01016333__M0E060
33000	35x79	0.40	15	13	10.2	K01016333__M0E079
47000	35x79	0.55	13	12	10.8	K01016473__M0E079
47000	51x79	0.55	13	12	12.5	K01016473__M0G079
68000	51x79	0.60	12	11	15.7	K01016683__M0G079
100000	51x79	0.80	10	11	16.5	K01016104__M0G079
100000	51x105	0.80	10	10	18.7	K01016104__M0G105
150000	51x105	1.10	10	9	19.5	K01016154__M0G105
150000	63x105	1.10	10	9	21.5	K01016154__M0H105
220000	63x105	1.50	8	8	22.4	K01016224__M0H105
330000	63x105	1.90	8	8	23.3	K01016334__M0H105
330000	76x105	1.90	8	8	25.0	K01016334__M0J105
470000	76x105	1.90	5	5	28.5	K01016474__M0J105
470000	76x143	1.90	5	5	32.0	K01016474__M0J143
680000	76x143	2.50	4	4	32.5	K01016684__M0J143
1000000	76x143	2.50	3	3	34.5	K01016105__M0J143
1500000	90x220	3.00	3	3	48.7	K01016155__M0L220

**RATED  
VOLTAGE  
VDC**

**16V**

Cap $\mu\text{F}$	$\varnothing \times L$ mm	Tan $\delta$ MAX 100 Hz 20°C	ESR TYP m $\Omega$ 100 Hz 20°C	Z TYP m $\Omega$ 10 kHz 20°C	Ir a.c. A max 100 Hz 85°C	PART NUMBER stud and insert style excluded
10000	35x60	0.25	27	21	5.9	K01025103__M0E060
15000	35x60	0.28	16	12	9.3	K01025153__M0E060
22000	35x79	0.35	18	16	11.8	K01025223__M0E079
33000	35x79	0.40	15	14	12.1	K01025333__M0E079
33000	51x79	0.40	15	14	13.3	K01025333__M0G079
47000	51x79	0.50	12	10	15.7	K01025473__M0G079
68000	51x79	0.60	10	9	16.4	K01025683__M0G079
68000	51x105	0.60	10	9	18.7	K01025683__M0G105
100000	51x105	0.70	10	9	19.5	K01025104__M0G105
100000	63x105	0.70	10	9	21.5	K01025104__M0H105
150000	63x105	1.00	9	9	22.0	K01025154__M0H105
150000	76x105	1.00	9	9	23.5	K01025154__M0J105
220000	76x105	1.50	9	9	24.2	K01025224__M0J105
220000	76x143	1.50	9	9	28.5	K01025224__M0J143
330000	76x143	2.00	9	9	30.5	K01025334__M0J143
470000	76x214	2.00	5	5	35.6	K01025474__M0J214

**RATED  
VOLTAGE  
VDC**

**25V**

## K01 TYPE STANDARD RATINGS

Cap µF	Ø x L mm	Tan δ MAX 100 Hz 20°C	ESR TYP m Ω 100 Hz 20°C	Z TYP m Ω 10 kHz 20°C	Ir a.c. A max 100 Hz 85°C	PART NUMBER stud and insert style excluded
10000	35x60	0.20	18	12	6.5	K01040103__M0E060
15000	35x60	0.25	13	10	7.4	K01040153__M0E060
15000	35x79	0.25	13	10	8.6	K01040153__M0E079
22000	35x79	0.30	16	14	8.9	K01040223__M0E079
22000	51x79	0.30	16	14	10.4	K01040223__M0G079
33000	51x79	0.35	15	13	13.5	K01040333__M0G079
47000	51x79	0.40	10	9	14.2	K01040473__M0G079
47000	51x105	0.40	10	9	15.1	K01040473__M0G105
47000	63x105	0.40	10	9	17.6	K01040473__M0H105
68000	51x105	0.50	10	8	18.2	K01040683__M0G105
68000	63x105	0.50	10	8	19.5	K01040683__M0H105
100000	63x105	0.60	9	8	21.2	K01040104__M0H105
150000	76x105	0.90	9	8	25.7	K01040154__M0J105
220000	76x143	1.00	6	6	31.5	K01040224__M0J143
330000	76x214	1.20	5	5	38.5	K01040334__M0J214

**RATED  
VOLTAGE  
VDC**

**40V**

Cap µF	Ø x L mm	Tan δ MAX 100 Hz 20°C	ESR TYP m Ω 100 Hz 20°C	Z TYP m Ω 10 kHz 20°C	Ir a.c. A max 100 Hz 85°C	PART NUMBER stud and insert style excluded
4700	35x60	0.20	33	30	5.6	K01050472__M0E060
6800	35x60	0.20	25	24	7.0	K01050682__M0E060
10000	35x60	0.20	21	20	10.0	K01050103__M0E060
15000	35x79	0.25	17	15	11.3	K01050153__M0E079
22000	51x79	0.30	16	13	13.1	K01050223__M0G079
33000	51x105	0.35	15	13	16.0	K01050333__M0G105
47000	51x105	0.40	12	10	16.2	K01050473__M0G105
47000	63x105	0.40	12	10	18.3	K01050473__M0H105
68000	63x105	0.60	12	9	18.0	K01050683__M0H105
68000	76x105	0.60	12	9	22.1	K01050683__M0J105
100000	76x105	0.90	8	8	23.8	K01050104__M0J105
100000	76x143	0.90	8	8	25.8	K01050104__M0J143
150000	76x143	1.00	6	6	31.5	K01050154__M0J143

**RATED  
VOLTAGE  
VDC**

**50V**



## K01 TYPE STANDARD RATINGS

Cap µF	Ø x L mm	Tan δ MAX 100 Hz 20°C	ESR TYP m Ω 100 Hz 20°C	Z TYP m Ω 10 kHz 20°C	Ir a.c. A max 100 Hz 85°C	PART NUMBER stud and insert style excluded
4700	35x60	0.15	29	25	6.2	K01063472__M0E060
6800	35x60	0.18	21	20	7.0	K01063682__M0E060
10000	35x79	0.20	21	20	8.7	K01063103__M0E079
10000	51x79	0.20	18	16	10.1	K01063103__M0G079
15000	51x79	0.25	15	13	11.1	K01063153__M0G079
22000	51x79	0.30	13	11	12.4	K01063223__M0G079
22000	51x105	0.30	13	11	14.6	K01063223__M0G105
33000	51x105	0.35	11	10	15.6	K01063333__M0G105
33000	63x105	0.35	11	10	17.9	K01063333__M0H105
47000	51x105	0.45	10	9	15.8	K01063473__M0G105
47000	63x105	0.45	11	10	18.8	K01063473__M0H105
68000	76x105	0.50	11	10	25.7	K01063683__M0J105
100000	76x105	0.55	8	8	31.5	K01063104__M0J105
100000	76x143	0.55	8	8	34.5	K01063104__M0J143
150000	76x143	0.60	6	6	36.1	K01063154__M0J143

**RATED  
VOLTAGE  
VDC**

**63V**

Cap µF	Ø x L mm	Tan δ MAX 100 Hz 20°C	ESR TYP m Ω 100 Hz 20°C	Z TYP m Ω 10 kHz 20°C	Ir a.c. A max 100 Hz 85°C	PART NUMBER stud and insert style excluded
4700	35x60	0.15	29	25	5.4	K01075472__M0E060
6800	35x79	0.18	20	20	8.5	K01075682__M0E079
10000	51x79	0.20	18	16	11.0	K01075103__M0G079
15000	51x105	0.25	15	13	12.7	K01075153__M0G105
22000	51x105	0.30	12	11	15.2	K01075223__M0G105
22000	63x105	0.30	12	11	16.2	K01075223__M0H105
33000	63x105	0.35	11	10	16.8	K01075333__M0H105
33000	76x105	0.35	11	10	18.5	K01075333__M0J105
47000	76x105	0.45	10	10	20.1	K01075473__M0J105
47000	76x143	0.45	10	10	22.1	K01075473__M0J143
68000	76x143	0.60	10	10	26.0	K01075683__M0J143
100000	76x143	0.60	8	8	34.9	K01075104__M0J143

**RATED  
VOLTAGE  
VDC**

**75V**

## K01 TYPE STANDARD RATINGS

Cap $\mu\text{F}$	$\varnothing \times L$ mm	Tan $\delta$ MAX 100 Hz 20°C	ESR TYP $\text{m}\Omega$ 100 Hz 20°C	Z TYP $\text{m}\Omega$ 10 kHz 20°C	Ir a.c. A max 100 Hz 85°C	PART NUMBER stud and insert style excluded
1500	35x60	0.15	84	65	4.0	K01100152__M0E060
2200	35x60	0.15	57	47	5.0	K01100222__M0E060
3300	35x60	0.15	48	39	5.3	K01100332__M0E060
3300	35x79	0.15	48	39	6.8	K01100332__M0E079
4700	35x79	0.15	30	26	7.5	K01100472__M0E079
4700	51x79	0.15	30	26	10.0	K01100472__M0G079
6800	51x79	0.20	23	20	11.1	K01100682__M0G079
10000	51x79	0.20	16	14	11.9	K01100103__M0G079
10000	51x105	0.20	16	14	13.9	K01100103__M0G105
10000	63x105	0.20	16	14	14.5	K01100103__M0H105
15000	51x105	0.25	13	12	14.8	K01100153__M0G105
15000	63x105	0.25	13	12	17.5	K01100153__M0H105
22000	63x105	0.25	12	12	18.2	K01100223__M0H105
33000	76x105	0.25	10	10	23.1	K01100333__M0J105
47000	76x143	0.30	10	9	30.2	K01100473__M0J143
68000	76x143	0.30	8	8	36.5	K01100683__M0J143
68000	76x214	0.40	6	5	39.5	K01100683__M0J214

**RATED  
VOLTAGE  
VDC**

**100V**

Cap $\mu\text{F}$	$\varnothing \times L$ mm	Tan $\delta$ MAX 100 Hz 20°C	ESR TYP $\text{m}\Omega$ 100 Hz 20°C	Z TYP $\text{m}\Omega$ 10 kHz 20°C	Ir a.c. A max 100 Hz 85°C	PART NUMBER stud and insert style excluded
1000	35x79	0.10	98	90	4.0	K01160102__M0E079
1500	51x79	0.10	62	71	5.3	K01160152__M0G079
2200	51x79	0.10	50	43	7.0	K01160222__M0G079
3300	51x105	0.12	35	30	8.6	K01160332__M0G105
4700	51x105	0.12	25	25	10.9	K01160472__M0G105
4700	63x105	0.12	25	25	11.9	K01160472__M0H105
6800	51x105	0.12	21	22	11.4	K01160682__M0G105
6800	63x105	0.12	20	22	13.0	K01160682__M0H105
10000	76x105	0.15	13	12	17.4	K01160103__M0J105
10000	76x143	0.15	13	12	19.4	K01160103__M0J143
15000	76x143	0.15	11	10	20.9	K01160153__M0J143
22000	76x143	0.20	10	10	26.4	K01160223__M0J143
33000	76x214	0.20	8	8	34.1	K01160333__M0J214

**RATED  
VOLTAGE  
VDC**

**160V**

## K01 TYPE STANDARD RATINGS

Cap $\mu\text{F}$	$\varnothing \times \text{L}$ mm	Tan $\delta$ MAX 100 Hz 20°C	ESR TYP m $\Omega$ 100 Hz 20°C	Z TYP m $\Omega$ 10 kHz 20°C	Ir a.c. A max 100 Hz 85°C	PART NUMBER stud and insert style excluded
680	35X60	0.10	124	119	3.4	K01200681__M0E060
1000	35x79	0.10	86	88	3.5	K01200102__M0E079
1500	51x79	0.10	60	63	5.8	K01200152__M0G079
2200	51x105	0.10	40	37	7.2	K01200222__M0G105
3300	51x105	0.12	32	30	9.0	K01200332__M0G105
3300	63x105	0.12	31	29	10.2	K01200332__M0H105
4700	51x105	0.12	28	26	10.4	K01200472__M0G105
4700	63x105	0.12	27	25	11.1	K01200472__M0H105
5600	63x105	0.12	21	18	12.1	K01200562__M0H105
6800	63x105	0.12	20	16	13.9	K01200682__M0H105
6800	76x105	0.12	19	15	14.3	K01200682__M0J105
8200	76x105	0.12	16	14	14.8	K01200822__M0J105
10000	76x105	0.15	13	12	15.8	K01200103__M0J105
10000	76x143	0.15	13	12	18.6	K01200103__M0J143
15000	76x143	0.18	12	12	21.4	K01200153__M0J143
22000	76x143	0.18	9	9	28.9	K01200223__M0J143
33000	76x214	0.22	8	8	36.1	K01200333__M0J214

**RATED  
VOLTAGE  
VDC**

**200V**

Cap $\mu\text{F}$	$\varnothing \times \text{L}$ mm	Tan $\delta$ MAX 100 Hz 20°C	ESR TYP m $\Omega$ 100 Hz 20°C	Z TYP m $\Omega$ 10 kHz 20°C	Ir a.c. A max 100 Hz 85°C	PART NUMBER stud and insert style excluded
470	35x60	0.10	211	200	2.8	K01250471__M0E060
680	35x79	0.10	127	121	3.5	K01250681__M0E079
1000	35x79	0.10	86	88	4.1	K01250102__M0E079
1500	51x79	0.10	64	56	5.0	K01250152__M0G079
2200	51x105	0.10	40	36	7.5	K01250222__M0G105
3300	51x105	0.12	31	26	9.8	K01250332__M0G105
3300	63x105	0.12	30	25	11.0	K01250332__M0H105
4700	63x105	0.12	24	21	11.8	K01250472__M0H105
4700	76x105	0.12	20	18	13.2	K01250472__M0J105
5600	76x105	0.12	17	16	13.8	K01250562__M0J105
6800	76x105	0.12	15	13	14.1	K01250682__M0J105
8200	76x143	0.12	14	13	16.0	K01250822__M0J105
10000	76x143	0.13	13	12	19.7	K01250103__M0J143
15000	76x143	0.13	11	11	21.9	K01250153__M0J143
22000	76x214	0.14	10	9	34.2	K01250223__M0J214

**RATED  
VOLTAGE  
VDC**

**250V**

## K01 TYPE STANDARD RATINGS

**RATED  
VOLTAGE  
VDC**

**350V**

Cap µF	Ø x L mm	Tan δ MAX 100 Hz 20°C	ESR TYP m Ω 100 Hz 20°C	Z TYP m Ω 10 kHz 20°C	Ir a.c. A max 100 Hz 85°C	PART NUMBER stud and insert style excluded
470	35X60	0.10	170	136	3.3	K01350471__M0E060
680	35X79	0.10	108	95	4.0	K01350681__M0E079
1000	51x79	0.10	79	62	5.0	K01350102__M0G079
1000	51x105	0.10	79	62	5.5	K01350102__M0G105
1500	51x105	0.10	60	52	7.4	K01350152__M0G105
2200	51x105	0.10	44	40	9.0	K01350222__M0G105
2200	63x105	0.10	37	34	9.5	K01350222__M0H105
3300	63x105	0.12	26	22	10.1	K01350332__M0H105
3300	76x105	0.12	26	22	12.8	K01350332__M0J105
4700	76x105	0.12	17	16	14.5	K01350472__M0J105
4700	76x143	0.12	17	16	17.5	K01350472__M0J143
5600	76x143	0.12	17	16	18.5	K01350562__M0J143
6800	76x143	0.12	16	15	19.2	K01350682__M0J143
8200	76x143	0.12	16	15	20.7	K01350822__M0J143
10000	76x143	0.12	15	15	23.0	K01350103__M0J143
10000	76x214	0.14	15	14	26.6	K01350103__M0J214
15000	76x214	0.15	14	14	31.7	K01350153__M0J214
22000	90x220	0.20	13	13	35.4	K01350223__M0L220

**RATED  
VOLTAGE  
VDC**

**400V**

Cap µF	Ø x L mm	Tan δ MAX 100 Hz 20°C	ESR TYP m Ω 100 Hz 20°C	Z TYP m Ω 10 kHz 20°C	Ir a.c. A max 100 Hz 85°C	PART NUMBER stud and insert style excluded
220	35x60	0.10	350	288	2.1	K01400221__M0E060
330	35x60	0.10	290	273	2.8	K01400331__M0E060
470	35x60	0.10	160	149	3.0	K01400471__M0E060
470	35x79	0.10	165	155	3.5	K01400471__M0E079
680	51x79	0.10	120	115	4.7	K01400681__M0G079
680	51x105	0.10	124	120	5.1	K01400681__M0G105
1000	51x79	0.10	105	95	5.8	K01400102__M0G079
1000	51x105	0.10	110	85	6.3	K01400102__M0G105
1500	51x105	0.10	65	55	7.0	K01400152__M0G105
1500	63x105	0.10	65	55	7.9	K01400152__M0H105
2200	51x105	0.10	50	47	8.3	K01400222__M0G105
2200	63x105	0.10	50	47	9.0	K01400222__M0H105
2200	76x105	0.10	50	47	10.7	K01400222__M0J105
3300	63x105	0.12	35	30	11.0	K01400332__M0H105
3300	76x105	0.12	35	30	13.1	K01400332__M0J105
3300	76x143	0.12	35	30	14.2	K01400332__M0J143
4700	76x105	0.15	30	29	14.9	K01400472__M0J105
4700	76x143	0.15	30	29	16.8	K01400472__M0J143
5600	76x143	0.15	26	25	19.0	K01400562__M0J143
6800	76x143	0.15	20	18	19.5	K01400682__M0J143
8200	76x143	0.15	22	20	19.0	K01400822__M0J143
10000	76x143	0.15	22	20	19.0	K01400103__M0J143
10000	76x214	0.15	20	19	26.0	K01400103__M0J214
15000	90x220	0.20	15	12	33.5	K01400153__M0L220

## K01 TYPE STANDARD RATINGS

Cap μF	Ø x L mm	Tan δ MAX 100 Hz 20°C	ESR TYP m Ω 100 Hz 20°C	Z TYP m Ω 10 kHz 20°C	Ir a.c. A max 100 Hz 85°C	PART NUMBER stud and insert style excluded
220	35X60	0.10	360	300	2.0	K01450221__M0E060
330	35X60	0.10	240	210	2.8	K01450331__M0E060
470	51x79	0.10	200	179	4.0	K01450471__M0G079
680	51X79	0.10	140	128	4.4	K01450681__M0G079
680	51x105	0.10	140	128	5.0	K01450681__M0G105
1000	51x79	0.10	100	88	4.8	K01450102__M0G079
1000	51x105	0.10	100	88	6.4	K01450102__M0G105
1500	51X105	0.10	67	55	7.1	K01450152__M0G105
1500	63x105	0.10	67	55	8.0	K01450152__M0H105
2200	63x105	0.10	60	55	9.0	K01450222__M0H105
2200	76x105	0.10	60	47	11.2	K01450222__M0J105
2200	76x143	0.10	60	47	12.5	K01450222__M0J143
3300	76x105	0.12	35	30	11.2	K01450332__M0J105
3300	76x143	0.12	35	30	12.9	K01450332__M0J143
4700	76x143	0.15	32	30	15.0	K01450472__M0J143
5600	76x143	0.15	26	25	19.0	K01450562__M0J143
6800	76x143	0.15	23	22	19.0	K01450682__M0J143
8200	76x143	0.15	22	20	19.0	K01450822__M0J143
10000	76x143	0.20	22	20	19.0	K01450103__M0J143
10000	76x214	0.20	20	19	23.1	K01450103__M0J214
12000	76x214	0.20	15	12	29.8	K01450123__M0J214
15000	90x220	0.20	14	12	32.6	K01450153__M0L220

**RATED  
VOLTAGE  
VDC**

**450V**

Cap μF	Ø x L mm	Tan δ MAX 100 Hz 20°C	ESR TYP m Ω 100 Hz 20°C	Z TYP m Ω 10 kHz 20°C	Ir a.c. A max 100 Hz 85°C	PART NUMBER stud and insert style excluded
1000	51x105	0.15	125	114	4.0	K01500102__M0G105
1500	63x105	0.15	100	91	5.2	K01500152__M0H105
2200	76x105	0.15	70	66	7.4	K01500222__M0J105
2200	76x143	0.15	70	66	8.2	K01500222__M0J143
3300	76x143	0.15	55	53	10.3	K01500332__M0J143
4700	76x143	0.15	35	32	11.6	K01500472__M0J143
5600	76x214	0.15	26	22	19.8	K01500562__M0J214
6800	76x214	0.15	24	22	20.2	K01500682__M0J214

**RATED  
VOLTAGE  
VDC**

**500V**

PLEASE TO CONTACT OUR TECHNICAL SERVICE FOR MORE INFORMATION OR SPEC-IN ANALYSIS.

## USEFUL LIFE K01

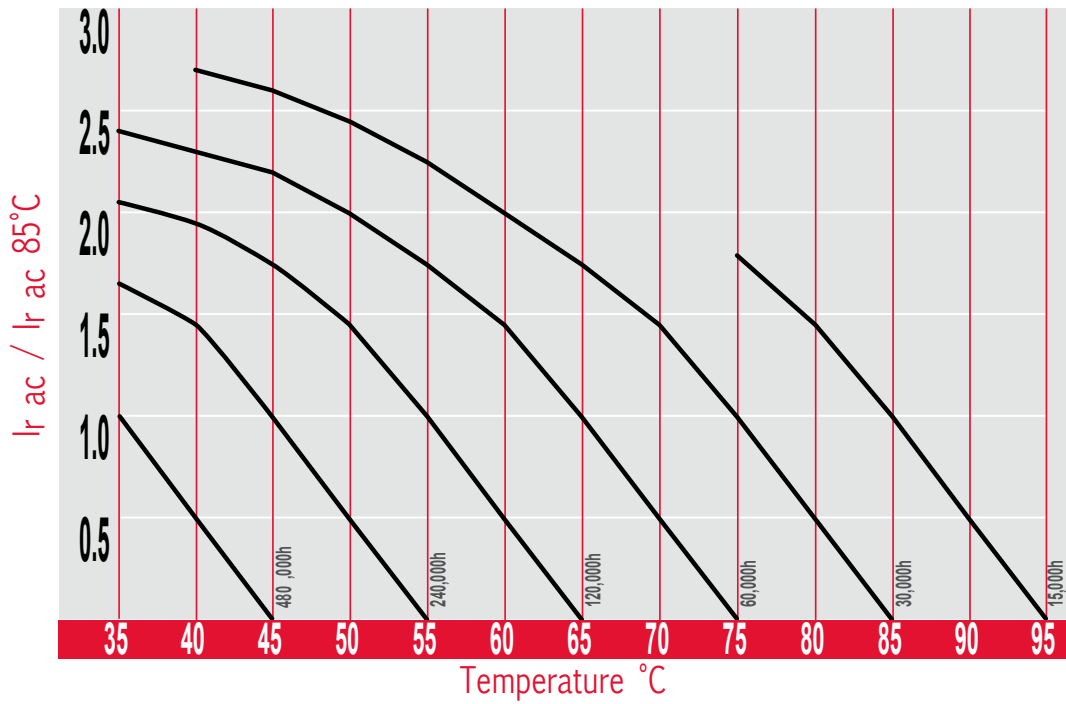

The graphs shows a typical trend of the standard capacitor load life.  
For a more accurate calculation of the load life for a specific capacitor, please use our calculator on the website [www.kendeil.com](http://www.kendeil.com) or enquiry our technical service.

# K02 TYPE -40°C +105°C 5000H

RoHS Compliant

- Surge-proof capacitor in aluminium can with insulation sleeve.
- Poles brought out to heavy duty screw terminals.
- To be mounted with ring clips or with threaded stud
- Very high CV for unit volume with low ESR and impedance.
- High ripple current capability. Extended temperature range.
- High level reliability with outstanding high frequency characteristics.

## APPLICATIONS

High professional power supplies. Switch power supplies, power converters, filtering devices, motor drive.

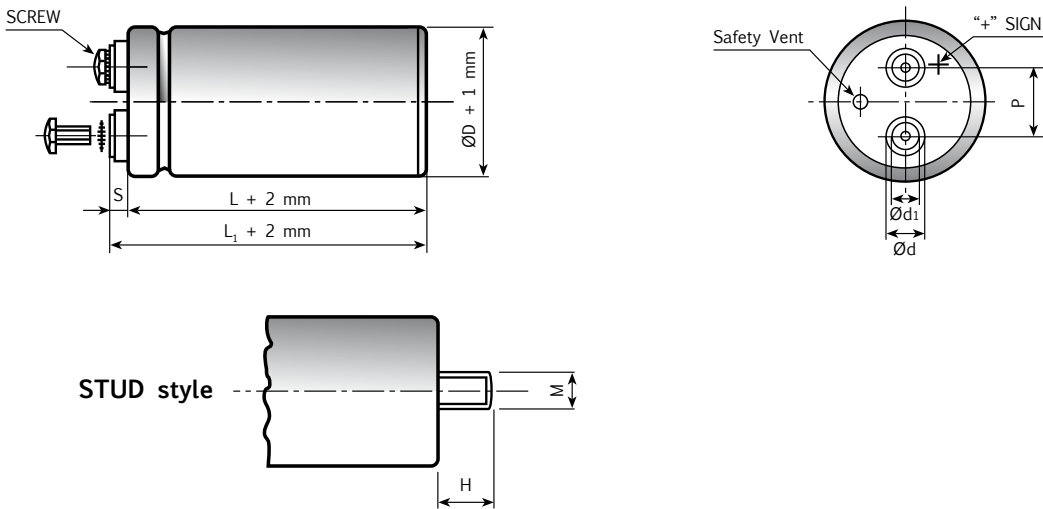

Diagram of dimensions (unit=mm)  
Insert and screw threads: Metric (mm), UNF (inches)

ØD	d	d1	P	STUD		INSERT	SCREW	L1	-L[-1+3]	S[-1+1]	INSERT STYLE CODE
				M	H						
35	11	7.9	12.7	M8	12	M5	5MA x 9.5	2.5		5	O
51	18.5	13	22.7	M12	16	M5	5MA x 9.5	2.5		5	H
63	18.5	13	28.6	M12	16	M5	5MA x 9.5	2.5		5	H
63	17.3	17.3	28.6	M12	16	UNF 1/4-28 Low Post	1/4-28 x 3/8"	3		4	W
63	17.3	17.3	28.6	M12	16	UNF 1/4-28 High Post	1/4-28 x 1/2"	6		7	R
63	7.9	7.9	28.6	M12	16	UNF 10-32 Low Post	10-32 x 1/4"	2		2.5	Z
63	12	7.9	28.6	M12	16	UNF 10-32 High Post	10-32 x 3/8"	6		7	U
76	18.5	13	31.8	M12	16	M5	5MA x 9.5	2.5		5	H
76	18.5	13	31.8	M12	16	M5	5MA x 9.5	2.5		7	L
76	23.2	17.7	31.8	M12	16	M6	6MA x 10	4.5		7	6
76	17.3	17.3	31.8	M12	16	UNF 1/4-28 Low Post	1/4-28 x 3/8"	3		4	W
76	17.3	17.3	31.8	M12	16	UNF 1/4-28 High Post	1/4-28 x 1/2"	6		7	R
76	7.9	7.9	31.8	M12	16	UNF 10-32 Low Post	10-32 x 1/4"	2		2.5	Z
76	12	7.9	31.8	M12	16	UNF 10-32 High Post	10-32 x 3/8"	6		7	U
90	23.2	17.7	31.8	M12	16	M6	6MA x 10	4.5		7	H

## SPECIFICATIONS

<b>Temperature Range</b>	Operating: -40°C +105°C Storage : Preferably below +25°C, not exceeding +40°C	[Environmental classification 40/105/56 IEC-68]																																																							
<b>Rated Voltage Range (V<sub>r</sub>)</b>	from 16V to 500V DC																																																								
<b>Surge Voltage (V<sub>p</sub>)</b>	V <sub>p</sub> = 1.15 V <sub>r</sub> (V <sub>r</sub> ≤ 250V DC) V <sub>p</sub> = 1.10 V <sub>r</sub> (V <sub>r</sub> > 250V DC)																																																								
<b>Rated Capacitance Range</b>	from 100 µF to 470,000 µF																																																								
<b>Capacitance Tolerance</b>	±20% at 100 Hz, 20°C [M class IEC-62] on request: -10% +30% at 100 Hz, 20°C [Q class IEC-62]																																																								
<b>Leakage Current (I<sub>L</sub>)</b> (mA, 5 min, 20°C)	max I <sub>L</sub> = 0.003 C <sub>r</sub> V <sub>r</sub> + 4 µA At 85°C max I <sub>L</sub> = 0.02 C <sub>r</sub> V <sub>r</sub> µA																																																								
<b>Ripple current (I<sub>r</sub>)</b>	Refer to table at 105°C and 100Hz. For different temperature and frequency multiplier must be used as follows:																																																								
	<table style="width: 100%; border-collapse: collapse;"> <tr> <td style="text-align: left;">FREQUENCY</td> <td>50Hz</td> <td>100Hz</td> <td>500 Hz</td> <td>1000Hz</td> <td>&gt;10kHz</td> <td></td> <td></td> <td></td> <td></td> <td></td> </tr> <tr> <td style="text-align: left;">MULTIPLIER</td> <td>0.8</td> <td>1.0</td> <td>1.2</td> <td>1.3</td> <td>1.5</td> <td></td> <td></td> <td></td> <td></td> <td></td> </tr> <tr> <td style="text-align: left;">AMBIENT TEMP</td> <td>35°C</td> <td>45°C</td> <td>55°C</td> <td>65°C</td> <td>75°C</td> <td>85°C</td> <td>95°C</td> <td>105°C</td> <td>110°C</td> <td></td> </tr> <tr> <td style="text-align: left;">MULTIPLIER</td> <td>3.0</td> <td>2.80</td> <td>2.60</td> <td>2.40</td> <td>2.20</td> <td>1.80</td> <td>1.5</td> <td>1.0</td> <td>0.5</td> <td></td> </tr> <tr> <td style="text-align: left;">Maximum internal temperature</td> <td colspan="10">108°C</td> </tr> </table>		FREQUENCY	50Hz	100Hz	500 Hz	1000Hz	>10kHz						MULTIPLIER	0.8	1.0	1.2	1.3	1.5						AMBIENT TEMP	35°C	45°C	55°C	65°C	75°C	85°C	95°C	105°C	110°C		MULTIPLIER	3.0	2.80	2.60	2.40	2.20	1.80	1.5	1.0	0.5		Maximum internal temperature	108°C									
FREQUENCY	50Hz	100Hz	500 Hz	1000Hz	>10kHz																																																				
MULTIPLIER	0.8	1.0	1.2	1.3	1.5																																																				
AMBIENT TEMP	35°C	45°C	55°C	65°C	75°C	85°C	95°C	105°C	110°C																																																
MULTIPLIER	3.0	2.80	2.60	2.40	2.20	1.80	1.5	1.0	0.5																																																
Maximum internal temperature	108°C																																																								
	Due to the current load capability of the contact elements, the following limits must not be exceeded:																																																								
	<table style="width: 100%; border-collapse: collapse;"> <tr> <td style="text-align: left;">CAPACITOR DIAMETER</td> <td>35mm</td> <td>51mm</td> <td>63mm</td> <td>76mm</td> <td>90mm</td> </tr> <tr> <td style="text-align: left;">Maximum current</td> <td>20A</td> <td>30A</td> <td>40A</td> <td>50A</td> <td>70A</td> </tr> </table>		CAPACITOR DIAMETER	35mm	51mm	63mm	76mm	90mm	Maximum current	20A	30A	40A	50A	70A																																											
CAPACITOR DIAMETER	35mm	51mm	63mm	76mm	90mm																																																				
Maximum current	20A	30A	40A	50A	70A																																																				
<b>Insulation Resistance</b>	At 100V DC for 1 min is >100 MΩ across insulating sleeve and terminals.																																																								
<b>Vibration Resistance</b>	Frequency range: 10 Hz to 55 Hz, amplitude 0.75 mm Capacitor length ≤ 143 : max acceleration 10g for 3x2 h Capacitor length > 143 : max acceleration 5g for 3x0.5 h																																																								
<b>Life test</b>	After 2,000 hours application of rated voltage at 105°C capacitors meet characteristics aside	Cap change ≤ 10% tan δ ≤ 130% Leakage current (I <sub>L</sub> ) < initial limit Impedance (Z) ≤ 130%																																																							
<b>Shelf life</b>	After leaving capacitors under no load for 500 hours at 105°C when restored at 20°C meet specifications aside	Cap change ≤ ±15% tan δ ≤ 150% Leakage current (I <sub>L</sub> ) < initial limit																																																							
<b>Useful life</b> (V <sub>n</sub> , Temp rated I ripple applied)	250000 h at 40°C 5000 h at 105°C																																																								
<b>Failure percentage</b> <b>Failure rate</b>	≤ 1% (during useful life) ≤ 30 fit (30 10 <sup>-9</sup> /h) (V <sub>r</sub> ≤ 160V DC) ≤ 40 fit (40 10 <sup>-9</sup> /h) (V <sub>r</sub> > 160V DC)																																																								
<b>Self inductance</b>	Approx. 20 nH																																																								
<b>Reference standards</b>	CECC 30.300 IEC 60384-4 LONG LIFE GRADE																																																								



## K02 TYPE STANDARD RATINGS

Cap $\mu\text{F}$	$\varnothing \times L$ mm	Tan $\delta$ MAX 100 Hz 20°C	ESR TYP m $\Omega$ 100 Hz 20°C	Z TYP m $\Omega$ 10 kHz 20°C	Ir a.c. A max 100 Hz 105°C	PART NUMBER stud and insert style excluded
10000	35x60	0.25	25	24	3.3	K02016103__M0E060
15000	35x60	0.30	16	16	3.5	K02016153__M0E060
22000	35x60	0.35	12	12	4.4	K02016223__M0E060
33000	35x60	0.40	12	12	4.6	K02016333__M0E060
47000	35x79	0.55	9	10	7.5	K02016473__M0E079
68000	51x79	0.60	8	8	11.9	K02016683__M0G079
100000	51x105	0.80	8	8	12.3	K02016104__M0G105
150000	63x105	1.10	7	7	15.4	K02016154__M0H105
220000	76x105	1.50	7	7	18.8	K02016224__M0J105
330000	76x105	1.90	7	7	19.7	K02016334__M0J105
470000	76x143	2.00	6	6	22.5	K02016474__M0J143

**RATED  
VOLTAGE  
VDC**

**16V**

Cap $\mu\text{F}$	$\varnothing \times L$ mm	Tan $\delta$ MAX 100 Hz 20°C	ESR TYP m $\Omega$ 100 Hz 20°C	Z TYP m $\Omega$ 10 kHz 20°C	Ir a.c. A max 100 Hz 105°C	PART NUMBER stud and insert style excluded
10000	35x60	0.20	23	18	3.8	K02025103__M0E060
15000	35x60	0.25	16	12	4.8	K02025153__M0E060
22000	35x60	0.30	12	12	7.0	K02025223__M0E060
33000	51x79	0.35	10	10	8.9	K02025333__M0G079
47000	51x79	0.40	9	9	11.6	K02025473__M0G079
68000	51x105	0.50	8	8	13.0	K02025683__M0G105
100000	63x105	0.60	8	8	15.8	K02025104__M0H105
150000	76x105	0.90	7	7	18.3	K02025154__M0J105
220000	76x143	1.30	7	7	21.6	K02025224__M0J143
330000	76x143	2.00	7	7	23.8	K02025334__M0J143

**RATED  
VOLTAGE  
VDC**

**25V**

Cap $\mu\text{F}$	$\varnothing \times L$ mm	Tan $\delta$ MAX 100 Hz 20°C	ESR TYP m $\Omega$ 100 Hz 20°C	Z TYP m $\Omega$ 10 kHz 20°C	Ir a.c. A max 100 Hz 105°C	PART NUMBER stud and insert style excluded
4700	35x60	0.20	31	29	3.3	K02040472__M0E060
6800	35x60	0.20	23	20	3.9	K02040682__M0E060
10000	35x79	0.20	16	12	4.8	K02040103__M0E079
15000	35x79	0.20	12	10	5.4	K02040153__M0E079
22000	51x79	0.25	10	10	8.9	K02040223__M0G079
33000	51x105	0.35	10	10	11.2	K02040333__M0G105
47000	51x105	0.45	9	9	13.8	K02040473__M0G105
47000	63x105	0.45	9	9	14.5	K02040473__M0H105
68000	63x105	0.60	7	7	15.0	K02040683__M0H105
68000	76x105	0.60	7	7	15.9	K02040683__M0J105
100000	76x105	0.90	7	7	19.1	K02040104__M0J105
100000	76x143	0.90	7	7	21.0	K02040104__M0J143
150000	76x143	1.30	7	7	25.9	K02040154__M0J143

**RATED  
VOLTAGE  
VDC**

**40V**

## K02 TYPE STANDARD RATINGS

Cap $\mu\text{F}$	$\varnothing \times L$ mm	Tan $\delta$ MAX 100 Hz 20°C	ESR TYP m $\Omega$ 100 Hz 20°C	Z TYP m $\Omega$ 10 kHz 20°C	Ir a.c. A max 100 Hz 105°C	PART NUMBER stud and insert style excluded
2200	35x60	0.15	72	60	2.5	K02063222__M0E060
3300	35x60	0.15	48	39	3.5	K02063332__M0E060
4700	35x60	0.15	33	28	4.2	K02063472__M0E060
6800	35x79	0.18	18	13	6.3	K02063682__M0E079
10000	51x79	0.20	15	11	8.2	K02063103__M0G079
15000	51x79	0.25	15	13	8.9	K02063153__M0G079
15000	51x105	0.25	13	10	18.0	K02063153__M0G105
22000	51x105	0.30	11	10	11.8	K02063223__M0G105
22000	63x105	0.30	11	10	13.5	K02063223__M0H105
33000	63x105	0.35	11	10	14.8	K02063333__M0H105
33000	76x105	0.35	11	8	16.6	K02063333__M0J105
47000	76x105	0.45	9	8	17.7	K02063473__M0J105
47000	76x143	0.45	9	8	19.0	K02063473__M0J143
68000	76x105	0.45	8	8	20.1	K02063683__M0J105
68000	76x143	0.70	8	8	22.8	K02063683__M0J143
100000	76x143	0.70	8	8	24.1	K02063104__M0J143

**RATED  
VOLTAGE  
VDC**

**63V**

Cap $\mu\text{F}$	$\varnothing \times L$ mm	Tan $\delta$ MAX 100 Hz 20°C	ESR TYP m $\Omega$ 100 Hz 20°C	Z TYP m $\Omega$ 10 kHz 20°C	Ir a.c. A max 100 Hz 105°C	PART NUMBER stud and insert style excluded
1000	35x60	0.15	110	100	2.9	K02100102__M0E060
1500	35x60	0.15	80	73	3.2	K02100152__M0E060
2200	35x60	0.15	59	53	4.4	K02100222__M0E060
3300	35x79	0.15	33	31	5.8	K02100332__M0E079
4700	51x79	0.15	25	22	7.2	K02100472__M0G079
6800	51x79	0.15	19	17	8.9	K02100682__M0G079
6800	51x105	0.15	19	17	8.9	K02100682__M0G105
10000	51x105	0.15	17	15	11.0	K02100103__M0G105
10000	63x105	0.15	17	15	12.5	K02100103__M0H105
15000	63x105	0.15	12	12	15.1	K02100153__M0H105
22000	76x105	0.18	10	9	16.5	K02100223__M0J105
33000	76x143	0.22	8	8	20.9	K02100333__M0J143

**RATED  
VOLTAGE  
VDC**

**100V**

## K02 TYPE STANDARD RATINGS

Cap $\mu\text{F}$	$\varnothing \times L$ mm	Tan $\delta$ MAX 100 Hz 20°C	ESR TYP m $\Omega$ 100 Hz 20°C	Z TYP m $\Omega$ 10 kHz 20°C	Ir a.c. A max 100 Hz 105°C	PART NUMBER stud and insert style excluded
1000	35x79	0.11	105	90	3.3	K02160102__M0E079
1500	51x79	0.11	65	60	4.1	K02160152__M0G079
2200	51X105	0.11	46	43	4.8	K02160222__M0G105
3300	63x105	0.11	32	30	6.8	K02160332__M0H105
4700	63x105	0.11	27	25	8.5	K02160472__M0H105
6800	76x105	0.13	23	20	11.3	K02160682__M0J105
10000	76x105	0.14	22	20	14.2	K02160103__M0J105
10000	76x143	0.15	17	16	14.9	K02160103__M0J143
15000	76x143	0.20	16	12	17.2	K02160153__M0J143
22000	76X214	0.20	11	10	19.0	K02160223__M0J214

**RATED  
VOLTAGE  
VDC**

**160V**

Cap $\mu\text{F}$	$\varnothing \times L$ mm	Tan $\delta$ MAX 100 Hz 20°C	ESR TYP m $\Omega$ 100 Hz 20°C	Z TYP m $\Omega$ 10 kHz 20°C	Ir a.c. A max 100 Hz 105°C	PART NUMBER stud and insert style excluded
680	35X60	0.11	133	98	2.5	K02200681__M0E060
1000	51x79	0.11	85	64	4.6	K02200102__M0G079
1500	51x105	0.11	65	58	5.1	K02200152__M0G105
2200	51x105	0.11	60	53	6.1	K02200222__M0G105
3300	63x105	0.11	40	35	7.9	K02200332__M0H105
4700	63x105	0.11	25	23	8.7	K02200472__M0H105
5600	63x105	0.11	22	20	9.8	K02200562__M0H105
6800	76X105	0.11	18	16	11.8	K02200682__M0J105
8200	76X105	0.11	17	15	12.8	K02200822__M0J105
10000	76x105	0.13	15	13	14.5	K02200103__M0J105
10000	76x143	0.15	13	12	16.0	K02200103__M0J143
15000	76x143	0.20	12	11	17.3	K02200153__M0J143
22000	76x214	0.20	11	10	18.9	K02200223__M0J214

**RATED  
VOLTAGE  
VDC**

**200V**

## K02 TYPE STANDARD RATINGS

Cap $\mu\text{F}$	$\varnothing \times L$ mm	Tan $\delta$ MAX 100 Hz 20°C	ESR TYP m $\Omega$ 100 Hz 20°C	Z TYP m $\Omega$ 10 kHz 20°C	Ir a.c. A max 100 Hz 105°C	PART NUMBER stud and insert style excluded
470	35x60	0.11	211	193	2.0	K02250471__M0E060
680	35x79	0.11	130	98	2.2	K02250681__M0E079
1000	51x79	0.11	110	85	4.1	K02250102__M0G079
1500	51x105	0.11	74	65	5.4	K02250152__M0G105
2200	51x105	0.11	41	39	6.8	K02250222__M0G105
3300	63x105	0.11	30	26	8.2	K02250332__M0H105
4700	76x105	0.11	18	17	11.9	K02250472__M0J105
5600	76x105	0.11	17	16	13.2	K02250562__M0J105
6800	76x143	0.15	15	14	14.3	K02250682__M0J143
8200	76x143	0.15	14	14	15.2	K02250822__M0J143
10000	76x143	0.20	14	13	16.0	K02250103__M0J143
15000	76x214	0.20	12	10	17.4	K02250153__M0J214

**RATED  
VOLTAGE  
VDC**

**250V**

Cap $\mu\text{F}$	$\varnothing \times L$ mm	Tan $\delta$ MAX 100 Hz 20°C	ESR TYP m $\Omega$ 100 Hz 20°C	Z TYP m $\Omega$ 10 kHz 20°C	Ir a.c. A max 100 Hz 105°C	PART NUMBER stud and insert style excluded
330	35x60	0.11	255	196	1.8	K02350331__M0E060
470	35x79	0.11	170	141	2.1	K02350471__M0E079
680	51x79	0.11	128	96	3.8	K02350681__M0G079
1000	51x105	0.11	85	68	5.0	K02350102__M0G105
1500	63x105	0.11	59	52	6.4	K02350152__M0H105
2200	76x105	0.11	44	40	8.1	K02350222__M0J105
3300	76x105	0.11	26	23	10.2	K02350332__M0J105
4700	76x143	0.11	18	16	13.5	K02350472__M0J143
5600	76x143	0.12	18	17	14.3	K02350562__M0J143
6800	76x143	0.15	16	15	15.1	K02350682__M0J143
8200	76x143	0.15	16	15	17.8	K02350822__M0J143
10000	76x214	0.20	15	14	19.9	K02350103__M0J214

**RATED  
VOLTAGE  
VDC**

**350V**

## K02 TYPE STANDARD RATINGS

Cap µF	Ø x L mm	Tan δ MAX 100 Hz 20°C	ESR TYP m Ω 100 Hz 20°C	Z TYP m Ω 10 kHz 20°C	Ir a.c. A max 100 Hz 105°C	PART NUMBER stud and insert style excluded
220	35x60	0.11	350	280	1.4	K02400221__M0E060
330	35x60	0.11	250	210	2.2	K02400331__M0E060
470	51x79	0.11	170	150	2.8	K02400471__M0G079
680	51x79	0.11	110	100	3.2	K02400681__M0G079
1000	51x105	0.11	95	82	4.1	K02400102__M0G105
1500	63x105	0.11	64	53	5.8	K02400152__M0H105
2200	63x105	0.11	45	53	6.0	K02400222__M0H105
2200	76x105	0.11	45	39	7.3	K02400222__M0J105
3300	76x143	0.11	28	25	11.1	K02400332__M0J143
4700	76x143	0.11	24	23	12.8	K02400472__M0J143
5600	76x143	0.12	21	17	12.9	K02400562__M0J143
6800	76x214	0.15	19	15	15.5	K02400682__M0J214
8200	76x214	0.15	18	16	18.0	K02400822__M0J214
10000	90x220	0.20	16	14	22.5	K02400103__M0L220

**RATED  
VOLTAGE  
VDC**

**400V**

Cap µF	Ø x L mm	Tan δ MAX 100 Hz 20°C	ESR TYP m Ω 100 Hz 20°C	Z TYP m Ω 10 kHz 20°C	Ir a.c. A max 100 Hz 105°C	PART NUMBER stud and insert style excluded
100	35x60	0.11	800	650	1.2	K02450101__M0E060
150	35x60	0.11	550	490	1.6	K02450151__M0E060
220	35x60	0.11	370	310	1.8	K02450221__M0E060
330	35x79	0.11	240	210	2.4	K02450331__M0E079
470	51x79	0.11	200	179	3.0	K02450471__M0G079
680	51x105	0.11	140	128	4.2	K02450681__M0G105
1000	51x105	0.11	100	88	4.4	K02450102__M0G105
1000	63x105	0.11	100	88	5.3	K02450102__M0H105
1500	63x105	0.11	63	57	5.7	K02450152__M0H105
1500	76x105	0.11	63	57	6.6	K02450152__M0J105
2200	76x143	0.11	60	47	8.8	K02450222__M0J143
3300	76x143	0.15	35	30	10.4	K02450332__M0J143
4700	76x143	0.15	28	25	10.9	K02450472__M0J143
5600	76x143	0.15	21	17	11.2	K0245056 2__M0J143
6800	76x214	0.15	21	16	15.5	K02450682__M0J214
8200	76x214	0.15	18	16	19.2	K02450822__M0J214
10000	90x220	0.20	16	14	22.5	K02450103__M0L220

**RATED  
VOLTAGE  
VDC**

**450V**

## K02 TYPE STANDARD RATINGS

Cap μF	Ø x L mm	Tan δ MAX 100 Hz 20°C	ESR TYP m Ω 100 Hz 20°C	Z TYP m Ω 10 kHz 20°C	I <sub>r</sub> a.c. A max 100 Hz 105°C	PART NUMBER termination digit excluded
1000	51x105	0.11	100	88	4.0	K02500102__HMOG105
1500	63x105	0.11	64	58	5.4	K02500152__HM0H105
1800	63x105	0.11	61	53	5.7	K02500182__HM0H105
2200	76x105	0.11	60	47	6.9	K02500222__HM0J105
2700	76x143	0.13	40	32	8.7	K02500272__HM0J143
3300	76x143	0.15	37	31	9.4	K02500332__HM0J143
3900	76x143	0.15	31	28	10.1	K02500392__HM0J143
4700	76x143	0.15	29	26	10.3	K02500472__HM0J143
5600	76x214	0.15	23	19	14.3	K02500562__HM0J214
6800	76x214	0.15	21	16	14.8	K02500682__HM0J214
6800	90x145	0.15	21	16	13.3	K02500682__HM0L145
8200	90x220	0.15	19	15	18.6	K02500822__HM0L220
10000	90x220	0.20	17	15	20.0	K02500103__HM0L220

**RATED  
VOLTAGE  
VDC**

**500V**

## USEFUL LIFE K02

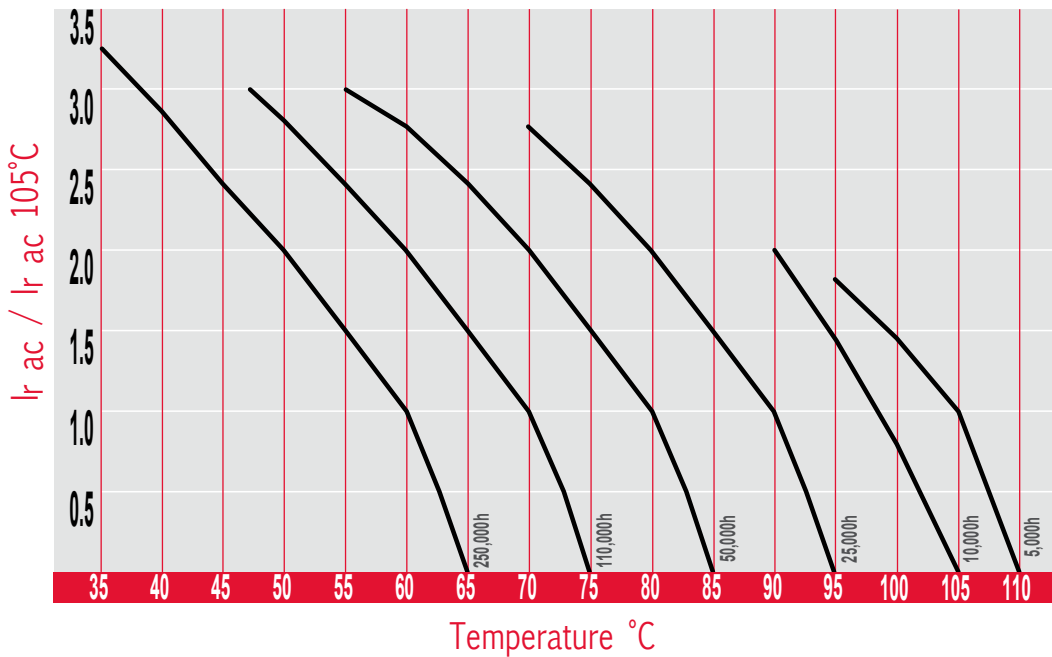

The graphs shows a typical trend of the standard capacitor load life. For a more accurate calculation of the load life for a specific capacitor, please use our calculator on the website [www.kendeil.com](http://www.kendeil.com) or enquiry our technical service.

**PLEASE TO CONTACT OUR TECHNICAL SERVICE FOR MORE INFORMATION OR SPEC-IN ANALYSIS.**

- Surge-proof capacitor in aluminium can with insulation sleeve.
- Heavy charge/discharge duty.
- To be mounted with ring clips or with threaded stud.

**APPLICATIONS**

Extreme application welding. Strobe applications.

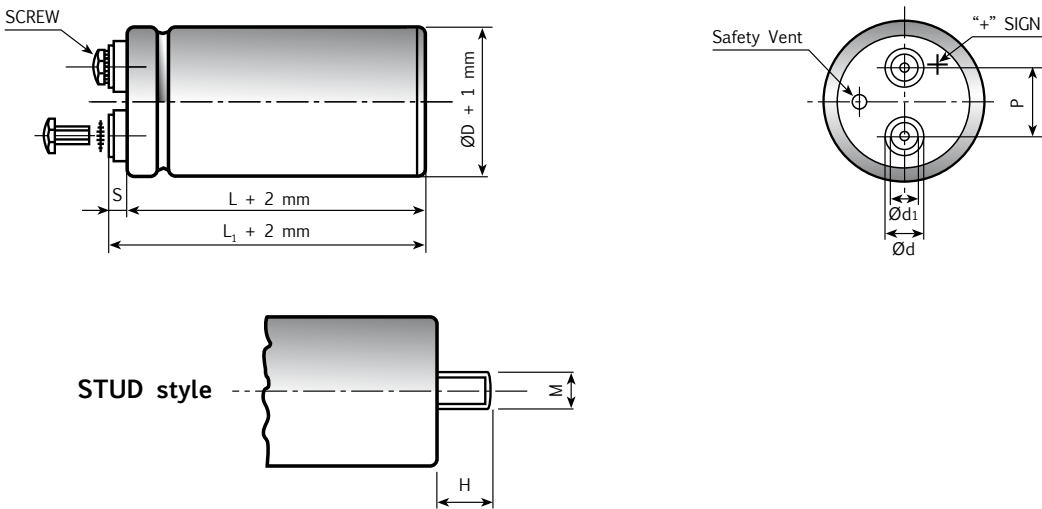

Diagram of dimensions (unit=mm)  
Insert and screw threads: Metric (mm), UNF (inches)

ØD	d	d1	P	STUD		INSERT	SCREW	L <sub>1</sub>	L[-1+3]	S[-1+1]	INSERT STYLE CODE
				M	H						
35	11	7.9	12.7	M8	12	M5	5MA x 9.5	2.5		5	O
51	18.5	13	22.7	M12	16	M5	5MA x 9.5	2.5		5	H
63	18.5	13	28.6	M12	16	M5	5MA x 9.5	2.5		5	H
63	17.3	17.3	28.6	M12	16	UNF 1/4-28 Low Post	1/4-28 x 3/8"	3		4	W
63	17.3	17.3	28.6	M12	16	UNF 1/4-28 High Post	1/4-28 x 1/2"	6		7	R
63	7.9	7.9	28.6	M12	16	UNF 10-32 Low Post	10-32 x 1/4"	2		2.5	Z
63	12	7.9	28.6	M12	16	UNF 10-32 High Post	10-32 x 3/8"	6		7	U
76	18.5	13	31.8	M12	16	M5	5MA x 9.5	2.5		5	H
76	18.5	13	31.8	M12	16	M5	5MA x 9.5	2.5		7	L
76	23.2	17.7	31.8	M12	16	M6	6MA x 10	4.5		7	6
76	17.3	17.3	31.8	M12	16	UNF 1/4-28 Low Post	1/4-28 x 3/8"	3		4	W
76	17.3	17.3	31.8	M12	16	UNF 1/4-28 High Post	1/4-28 x 1/2"	6		7	R
76	7.9	7.9	31.8	M12	16	UNF 10-32 Low Post	10-32 x 1/4"	2		2.5	Z
76	12	7.9	31.8	M12	16	UNF 10-32 High Post	10-32 x 3/8"	6		7	U
90	23.2	17.7	31.8	M12	16	M6	6MA x 10	4.5		7	H

## SPECIFICATIONS

<b>Temperature Range</b>	Operating: -20°C +70°C Storage : Preferably below +25°C, not exceeding +40°C
<b>Rated Voltage Range (V<sub>r</sub>)</b>	from 400V to 500V DC
<b>Surge Voltage (V<sub>p</sub>)</b>	V <sub>p</sub> = 1.05 V <sub>r</sub> (V <sub>r</sub> > = 475V DC) - V <sub>p</sub> = 1.10 V <sub>r</sub> (V <sub>r</sub> > 250V DC)
<b>Rated Capacitance Range</b>	from 560 μF to 3300 μF
<b>Capacitance Tolerance</b>	±20% at 100 Hz, 20°C [M class IEC-62] on request: -10% +30% at 100 Hz, 20°C [Q class IEC-62]
<b>Leakage Current (I<sub>L</sub>)</b> (5 min, 20°C)	max I <sub>L</sub> = 0.006 C <sub>r</sub> V <sub>r</sub> + 4 μA
<b>Insulation Resistance</b>	At 100V DC for 1 min is >100 M Ω across insulating sleeve and terminals.
<b>Vibration Resistance</b>	Frequency range: 10 Hz to 55 Hz, amplitude 0.75 mm Capacitor length ≤ 143 : max acceleration 10g for 3x2 h Capacitor length > 143 : max acceleration 5g for 3x0.5 h
<b>Discharge Life</b>	Test conditions: 10000 times at room temperatures (5-35°C) Charge and Discharge cycles: 30 sec  Cap change ≤ 10% tan δ ≤ 150% Leakage current (I <sub>L</sub> ) < 150% of initial limit Impedance (Z) ≤ 200%
<b>Shelf life</b>	After leaving capacitors under no load for 500 hours at 55°C when restored at 20°C meet specifications aside Cap change ≤ ±15% tan δ ≤ 150% Leakage current (I <sub>L</sub> ) < initial limit
<b>Failure percentage</b> <b>Failure rate</b>	≤ 1% (during useful life) ≤ 33 fit (33 10 <sup>-9</sup> /h) (V <sub>r</sub> > 160V DC)
<b>Self inductance</b>	Approx. 20 nH
<b>Reference standards</b>	CECC 30.300 IEC 60384-4 LONG LIFE GRADE



## K03 TYPE STANDARD RATINGS

Cap μF	Ø x L mm	Tan δ MAX 100 Hz 20°C	PART NUMBER stud and insert style excluded
680	51x105	0.10	K03400681__M0G105
820	51x105	0.10	K03400821__M0G105
1000	63x105	0.10	K03400102__M0H105
1200	63x105	0.10	K03400122__M0H105
1500	76x105	0.10	K03400152__M0J105
2200	76x143	0.10	K03400222__M0J143
3300	90x145	0.10	K03400332__M0L145

**RATED  
VOLTAGE  
VDC**

**400V**

Cap μF	Ø x L mm	Tan δ MAX 100 Hz 20°C	PART NUMBER stud and insert style excluded
680	51x105	0.10	K03450681__M0G105
820	51x105	0.10	K03450821__M0G105
1000	63x105	0.10	K03450102__M0H105
1200	63x105	0.10	K03450122__M0H105
1500	76x105	0.10	K03450152__M0J105
2200	76x143	0.10	K03450222__M0J143
3300	90x145	0.10	K03450332__M0L145

**RATED  
VOLTAGE  
VDC**

**450V**

Cap μF	Ø x L mm	Tan δ MAX 100 Hz 20°C	PART NUMBER stud and insert style excluded
560	51x105	0.15	K03475561__M0G105
680	51x105	0.15	K03475681__M0G105
820	51x105	0.15	K03475821__M0G105
1000	63x105	0.15	K03475102__M0H105
1000	63x105	0.15	K03475102__M0H105
1000	76x105	0.15	K03475102__M0J105
1000	76x143	0.15	K03475102__M0J143
1500	76x143	0.15	K03475152__M0J143
2200	90x145	0.15	K03475222__M0L145

**RATED  
VOLTAGE  
VDC**

**475V**

Cap μF	Ø x L mm	Tan δ MAX 100 Hz 20°C	PART NUMBER stud and insert style excluded
560	51x105	0.15	K03500581__M0G105
680	63x105	0.15	K03500681__M0H105
820	63x105	0.15	K03500821__M0H105
1000	63x105	0.15	K03500102__M0H105
1000	63x105	0.15	K03500102__M0H105
1000	63x143	0.15	K03500102__M0H143
1500	76x143	0.15	K03500152__M0J143
2200	90x145	0.15	K03500222__M0L145

**RATED  
VOLTAGE  
VDC**

**500V**

# K04 TYPE -40°C +85°C 20000H

RoHS Compliant

- Extended life
- Surge-proof capacitor in aluminium can with insulation sleeve.
- To be mounted with ring clips or with threaded stud.
- Designed for high resistances to voltage spikes.

## APPLICATIONS

Power supplies, motor drives, welding, energy storage.

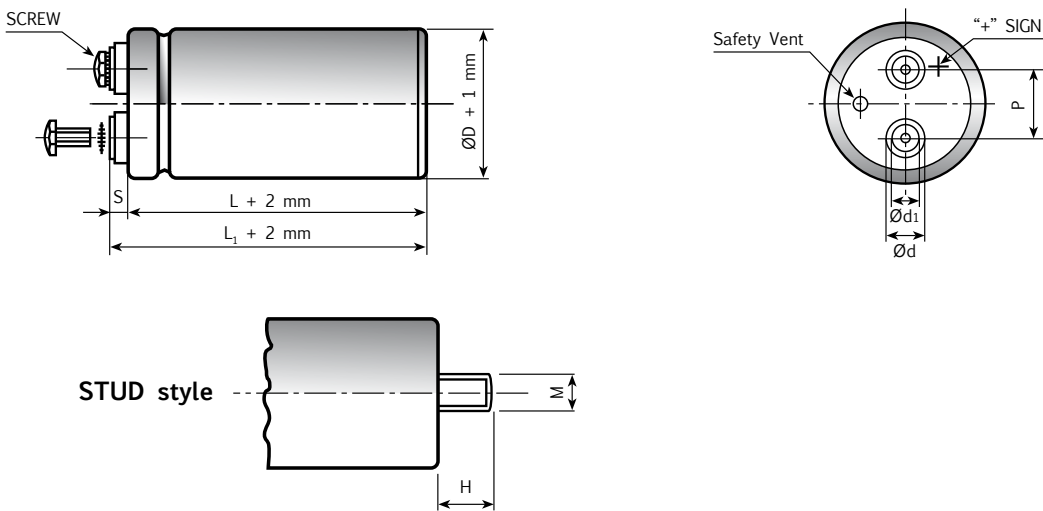

Diagram of dimensions (unit=mm)  
Insert and screw threads: Metric (mm), UNF (inches)

ØD	d	d1	P	STUD M	H	INSERT	SCREW	L1	-L[-1+3]	S[-1+1]	INSERT STYLE CODE
35	11	7.9	12.7	M8	12	M5	5MA x 9.5	2.5		5	O
51	18.5	13	22.7	M12	16	M5	5MA x 9.5	2.5		5	H
63	18.5	13	28.6	M12	16	M5	5MA x 9.5	2.5		5	H
63	17.3	17.3	28.6	M12	16	UNF 1/4-28 Low Post	1/4-28 x 3/8"	3		4	W
63	17.3	17.3	28.6	M12	16	UNF 1/4-28 High Post	1/4-28 x 1/2"	6		7	R
63	7.9	7.9	28.6	M12	16	UNF 10-32 Low Post	10-32 x 1/4"	2		2.5	Z
63	12	7.9	28.6	M12	16	UNF 10-32 High Post	10-32 x 3/8"	6		7	U
76	18.5	13	31.8	M12	16	M5	5MA x 9.5	2.5		5	H
76	18.5	13	31.8	M12	16	M5	5MA x 9.5	2.5		7	L
76	23.2	17.7	31.8	M12	16	M6	6MA x 10	4.5		7	6
76	17.3	17.3	31.8	M12	16	UNF 1/4-28 Low Post	1/4-28 x 3/8"	3		4	W
76	17.3	17.3	31.8	M12	16	UNF 1/4-28 High Post	1/4-28 x 1/2"	6		7	R
76	7.9	7.9	31.8	M12	16	UNF 10-32 Low Post	10-32 x 1/4"	2		2.5	Z
76	12	7.9	31.8	M12	16	UNF 10-32 High Post	10-32 x 3/8"	6		7	U
90	23.2	17.7	31.8	M12	16	M6	6MA x 10	4.5		7	H

## SPECIFICATIONS

<b>Temperature Range</b>	Operating: -40°C +85°C Storage : Preferably below +25°C, not exceeding +40°C	[Environmental classification 40/85/56 IEC-68]																																				
<b>Rated Voltage Range (V<sub>r</sub>)</b>	from 350V to 600V DC																																					
<b>Surge Voltage (V<sub>p</sub>)</b>	V <sub>p</sub> = 1.10 V <sub>r</sub> (V <sub>r</sub> ≤ 500 V DC)	V <sub>p</sub> = 1.05 V <sub>r</sub> (V <sub>r</sub> > 500 V DC)																																				
<b>Rated Capacitance Range</b>	from 1500 µF to 15000 µF																																					
<b>Capacitance Tolerance</b>	±20% at 100 Hz, 20°C [M class IEC-62] on request: -10% +30% at 100 Hz, 20°C [Q class IEC-62]																																					
<b>Leakage Current (I<sub>L</sub>)</b> (mA, 5 min, 20°C)	max I <sub>L</sub> = 0.006 C <sub>r</sub> V <sub>r</sub> + 4 µA At 85°C max I <sub>L</sub> = 0.04 C <sub>r</sub> V <sub>r</sub> µA	Kendeil product limit: I <sub>L</sub> = 0.003 C <sub>r</sub> V <sub>r</sub>																																				
<b>Ripple current (I<sub>r</sub>)</b>	Refer to table at 85°C and 100Hz: <table border="1" style="width: 100%; border-collapse: collapse;"> <thead> <tr> <th>FREQUENCY</th> <th>50Hz</th> <th>100 Hz</th> <th>500Hz</th> <th>1000Hz</th> <th>&gt;10kHz</th> </tr> </thead> <tbody> <tr> <td>MULTIPLIER</td> <td>0.8</td> <td>1.0</td> <td>1.2</td> <td>1.3</td> <td>1.5</td> </tr> </tbody> </table> <table border="1" style="width: 100%; border-collapse: collapse;"> <thead> <tr> <th>AMBIENT TEMP</th> <th>35°C</th> <th>45°C</th> <th>55°C</th> <th>65°C</th> <th>75°C</th> <th>85°C</th> <th>95°C</th> </tr> </thead> <tbody> <tr> <td>MULTIPLIER</td> <td>2.2</td> <td>2.1</td> <td>1.8</td> <td>1.6</td> <td>1.4</td> <td>1.0</td> <td>0.5</td> </tr> </tbody> </table> Due to the current load capability of the contact elements, the following limits must not be exceeded: <table border="1" style="width: 100%; border-collapse: collapse;"> <thead> <tr> <th>CAPACITOR DIAMETER</th> <th>63mm</th> <th>76mm</th> <th>90mm</th> </tr> </thead> <tbody> <tr> <td>Maximum current</td> <td>40A</td> <td>50A</td> <td>70A</td> </tr> </tbody> </table>		FREQUENCY	50Hz	100 Hz	500Hz	1000Hz	>10kHz	MULTIPLIER	0.8	1.0	1.2	1.3	1.5	AMBIENT TEMP	35°C	45°C	55°C	65°C	75°C	85°C	95°C	MULTIPLIER	2.2	2.1	1.8	1.6	1.4	1.0	0.5	CAPACITOR DIAMETER	63mm	76mm	90mm	Maximum current	40A	50A	70A
FREQUENCY	50Hz	100 Hz	500Hz	1000Hz	>10kHz																																	
MULTIPLIER	0.8	1.0	1.2	1.3	1.5																																	
AMBIENT TEMP	35°C	45°C	55°C	65°C	75°C	85°C	95°C																															
MULTIPLIER	2.2	2.1	1.8	1.6	1.4	1.0	0.5																															
CAPACITOR DIAMETER	63mm	76mm	90mm																																			
Maximum current	40A	50A	70A																																			
<b>Insulation Resistance</b>	At 100V DC for 1 min is >100 MΩ across insulating sleeve and terminals.																																					
<b>Vibration Resistance</b>	Frequency range: 10 Hz to 55 Hz, amplitude 0.75 mm Capacitor length ≤ 143 : max acceleration 10g for 3x2 h Capacitor length > 143 : max acceleration 5g for 3x0.5 h																																					
<b>Life test</b>	After 4,000 hours application of rated voltage at 85°C capacitors meet characteristics aside	Cap change ≤ 10% tan δ ≤ 130% Leakage current (I <sub>L</sub> ) < initial limit Impedance (Z) ≤ 130%																																				
<b>Shelf life</b>	After leaving capacitors under no load for 2000 hours at 85°C, when restored at 20°C meet specifications aside	Cap change ≤ ±15% tan δ ≤ 150% Leakage current (I <sub>L</sub> ) < initial limit																																				
<b>Working life</b> (V <sub>n</sub> , Temp rated I ripple applied)	> 20000 h 85°C for V< 450V > 15000 h for V≤ 500V > 12000 h for V= 550V > 6000 h for V= 600V	Cap change ≤ ±25% tan δ ≤ 300% Leakage current (I <sub>L</sub> ) < initial limit																																				
<b>Failure percentage</b> <b>Failure rate</b>	≤ 1% (during working life) ≤ 33 fit (33 10 <sup>-9</sup> /h)																																					
<b>Self inductance</b>	Approx. 20 nH																																					
<b>Reference standards</b>	CECC 30.300 IEC 60384-4 LONG LIFE GRADE																																					

## K04 TYPE STANDARD RATINGS

Cap $\mu\text{F}$	$\varnothing \times L$ mm	Tan $\delta$ MAX 100 Hz 20°C	ESR TYP m $\Omega$ 100 Hz 20°C	Z TYP m $\Omega$ 10 kHz 20°C	Ir a.c. A max 100 Hz 85°C	PART NUMBER stud and insert style excluded
2200	63x105	0.13	42	30	11.0	K04350222__M0H105
3300	63x105	0.13	30	22	12.6	K04350332__M0H105
3300	76x105	0.13	30	22	13.8	K04350332__M0H105
4700	76x105	0.13	23	15	16.1	K04350472__M0J105
4700	76x143	0.13	23	15	18.5	K04350472__M0J143
5600	76x143	0.15	19	14	20.0	K04350562__M0J143
6800	76x143	0.15	15	11	21.8	K04350682__M0J143
8200	76x143	0.15	13	9	23.6	K04350822__M0J143
10000	76x214	0.17	11	8	31.7	K04350103__M0J214
15000	90x220	0.18	7	5	42.0	K04350153__M0L220

**RATED  
VOLTAGE  
VDC**

**350V**

Cap $\mu\text{F}$	$\varnothing \times L$ mm	Tan $\delta$ MAX 100 Hz 20°C	ESR TYP m $\Omega$ 100 Hz 20°C	Z TYP m $\Omega$ 10 kHz 20°C	Ir a.c. A max 100 Hz 85°C	PART NUMBER stud and insert style excluded
1500	63x105	0.15	105	85	7.5	K04400152__M0H105
2200	63x105	0.15	80	63	8.8	K04400222__M0H105
2200	76x105	0.15	80	63	10.2	K04400222__M0J105
3300	63x105	0.15	50	40	10.7	K04400332__M0H105
3300	76x143	0.15	50	40	14.1	K04400332__M0J143
4700	76x105	0.17	40	32	14.7	K04400472__M0J105
4700	76x143	0.17	40	32	17.7	K04400472__M0J143
6800	76x143	0.17	27	22	18.0	K04400682__M0J143
10000	76x214	0.20	20	17	27.8	K04400103__M0J214

**RATED  
VOLTAGE  
VDC**

**400V**

Cap $\mu\text{F}$	$\varnothing \times L$ mm	Tan $\delta$ MAX 100 Hz 20°C	ESR TYP m $\Omega$ 100 Hz 20°C	Z TYP m $\Omega$ 10 Hz 20°C	Ir a.c. A max 100 Hz 85°C	PART NUMBER stud and insert style excluded
1500	63x105	0.15	105	85	7.5	K04420152__M0H105
2200	63x105	0.15	80	63	8.8	K04420222__M0H105
2200	76x105	0.15	80	63	10.2	K04420222__M0J105
3300	63x105	0.15	50	40	10.7	K04420332__M0H105
3300	76x143	0.15	50	40	14.1	K04420332__M0J143
4700	76x105	0.17	40	32	14.7	K04420472__M0J105
4700	76x143	0.17	40	32	17.7	K04420472__M0J143
6800	76x143	0.17	27	22	18.0	K04420682__M0J143
10000	76x214	0.20	20	17	27.8	K04420103__M0J214

**RATED  
VOLTAGE  
VDC**

**420V**

## K04 TYPE STANDARD RATINGS

Cap $\mu\text{F}$	$\varnothing$ x L mm	Tan $\delta$ MAX 100 Hz 20°C	ESR TYP m $\Omega$ 100 Hz 20°C	Z TYP m $\Omega$ 10 Hz 20°C	I <sub>r</sub> a.c. A max 100 Hz 85°C	PART NUMBER stud and insert style excluded
1500	63x105	0.15	105	85	7.5	K04450152__M0H105
2200	63x105	0.15	80	63	8.8	K04450222__M0H105
2200	76x105	0.15	80	63	10.2	K04450222__M0J105
3300	63x105	0.15	50	40	10.7	K04450332__M0H105
3300	76x143	0.15	50	40	14.1	K04450332__M0J143
4700	76x105	0.17	40	32	14.7	K04450472__M0J105
4700	76x143	0.17	40	32	17.7	K04450472__M0J143
6800	76x143	0.17	27	22	18.0	K04450682__M0J143
10000	76x214	0.20	20	17	27.8	K04450103__M0J214
12000	90x220	0.20	15	11	34.5	K04450123__M0L220

**RATED  
VOLTAGE  
VDC**

**450V**

Cap $\mu\text{F}$	$\varnothing$ x L mm	Tan $\delta$ MAX 100 Hz 20°C	ESR TYP m $\Omega$ 100 Hz 20°C	Z TYP m $\Omega$ 10 Hz 20°C	I <sub>r</sub> a.c. A max 100 Hz 85°C	PART NUMBER stud and insert style excluded
1500	63x105	0.15	95	76	7.7	K04500152__M0H105
2200	63x105	0.15	65	55	8.9	K04500222__M0H105
2200	76x105	0.15	65	55	10.0	K04500222__M0J105
2200	76x143	0.15	65	55	11.4	K04500222__M0J143
3300	76x143	0.15	48	39	13.9	K04500332__M0J143
3900	76x143	0.17	38	34	14.7	K04500392__M0J143
4700	76x143	0.17	38	33	16.1	K04500472__M0J143
5600	76x143	0.17	30	26	17.5	K04500562__M0J143
6800	76x214	0.17	27	22	23.0	K04500682__M0J214
10000	90x220	0.20	20	17	30.4	K04500103__M0L220

**RATED  
VOLTAGE  
VDC**

**500V**

Cap $\mu\text{F}$	$\varnothing$ x L mm	Tan $\delta$ MAX 100 Hz 20°C	ESR TYP m $\Omega$ 100 Hz 20°C	Z TYP m $\Omega$ 10 Hz 20°C	I <sub>r</sub> a.c. A max 100 Hz 85°C	PART NUMBER stud and insert style excluded
1500	63x105	0.19	109	88	6.5	K04550152__M0H105
1800	76x105	0.19	99	80	7.6	K04550182__M0J105
2200	76x143	0.19	81	70	9.5	K04550222__M0J143
3300	76x143	0.20	59	49	10.2	K04550332__M0J143
4700	76x214	0.20	48	41	16.0	K04550472__M0J214
6800	90x220	0.21	34	28	18.1	K04550682__M0L220

**RATED  
VOLTAGE  
VDC**

**550V**

## K04 TYPE STANDARD RATINGS

Cap µF	Ø x L mm	Tan δ MAX 100 Hz 20°C	ESR TYP m Ω 100 Hz 20°C	Z TYP m Ω 10 Hz 20°C	Ir a.c. A max 100 Hz 85°C	PART NUMBER termination digit excluded
1500	63x105	0.15	71	54	7.9	K04600152__HM0H105
1800	76x105	0.15	61	47	9.5	K04600182__HM0J105
2200	76x143	0.15	48	37	11.9	K04600222__HM0J143
3300	76x143	0.15	36	27	14.1	K04600332__HM0J143
3900	90x145	0.15	28	22	17.3	K04600392__HM0L145
4700	76x214	0.15	21	17	18.7	K04600472__HM0J214
4700	90x145	0.15	23	19	20.1	K04600472__HM0L145
6800	90x220	0.15	16	13	26.9	K04600682__HM0L220

**RATED  
VOLTAGE  
VDC**

**600V**

PLEASE TO CONTACT OUR TECHNICAL SERVICE FOR MORE INFORMATION OR SPEC-IN ANALYSIS.

# K07 TYPE -40°C +85°C 2000H

RoHS Compliant

- Surge-proof capacitor in aluminium can with insulation sleeve
- To be mounted with ring clips or with threaded stud
- Case size optimized for Asian Market

## APPLICATIONS

Industrial Market, UPS, Frequency Converters

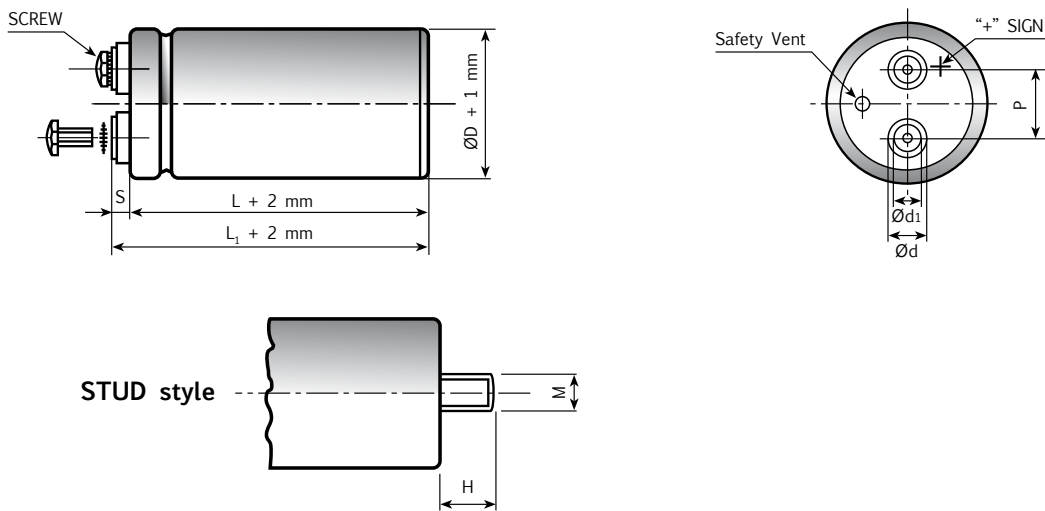

Diagram of dimensions (unit=mm)  
Insert and screw threads: Metric (mm), UNF (inches)

ØD	d	d1	P	STUD M	H	INSERT	SCREW	L <sub>1</sub>	-L[-1+3]	S[-1+1]	INSERT STYLE CODE
35	11	7.9	12.7	M8	12	M5	5MA x 9.5	2.5		5	O
51	18.5	13	22.7	M12	16	M5	5MA x 9.5	2.5		5	H
63	18.5	13	28.6	M12	16	M5	5MA x 9.5	2.5		5	H
63	17.3	17.3	28.6	M12	16	UNF 1/4-28 Low Post	1/4-28 x 3/8"	3		4	W
63	17.3	17.3	28.6	M12	16	UNF 1/4-28 High Post	1/4-28 x 1/2"	6		7	R
63	7.9	7.9	28.6	M12	16	UNF 10-32 Low Post	10-32 x 1/4"	2		2.5	Z
63	12	7.9	28.6	M12	16	UNF 10-32 High Post	10-32 x 3/8"	6		7	U
76	18.5	13	31.8	M12	16	M5	5MA x 9.5	2.5		5	H
76	18.5	13	31.8	M12	16	M5	5MA x 9.5	2.5		7	L
76	23.2	17.7	31.8	M12	16	M6	6MA x 10	4.5		7	6
76	17.3	17.3	31.8	M12	16	UNF 1/4-28 Low Post	1/4-28 x 3/8"	3		4	W
76	17.3	17.3	31.8	M12	16	UNF 1/4-28 High Post	1/4-28 x 1/2"	6		7	R
76	7.9	7.9	31.8	M12	16	UNF 10-32 Low Post	10-32 x 1/4"	2		2.5	Z
76	12	7.9	31.8	M12	16	UNF 10-32 High Post	10-32 x 3/8"	6		7	U
90	23.2	17.7	31.8	M12	16	M6	6MA x 10	4.5		7	H

## SPECIFICATIONS

<b>Temperature Range</b>	Operating: -40°C +85°C Storage : Preferably below +25°C, not exceeding +40°C																									
<b>Rated Voltage Range (V<sub>r</sub>)</b>	from 160V to 350V DC from 400V to 450V DC																									
<b>Surge Voltage (V<sub>p</sub>)</b>	V <sub>p</sub> = 1.15 V <sub>r</sub> (V <sub>r</sub> ≤ 250V DC) V <sub>p</sub> = 1.10 V <sub>r</sub> (V <sub>r</sub> > 250V DC)																									
<b>Rated Capacitance Range</b>	from 1800 μF to 47000 μF																									
<b>Capacitance Tolerance</b>	±20% at 120 Hz, 20°C [M class IEC-62] on request: -10% +30% at 120 Hz, 20°C [Q class IEC-62]																									
<b>Leakage Current (I<sub>L</sub>) (5 min, 20°C)</b>	max I <sub>L</sub> = 0.008 C <sub>r</sub> V <sub>r</sub> + 4 μA																									
<b>Ripple current (I<sub>r</sub>)</b>	<p>Refer to table at 85°C and 120Hz:</p> <table border="1"> <thead> <tr> <th>FREQUENCY</th> <th>50Hz</th> <th>100Hz</th> <th>500Hz</th> <th>1000Hz</th> <th>&gt;10kHz</th> </tr> </thead> <tbody> <tr> <td>MULTIPLIER</td> <td>0.88</td> <td>1.0</td> <td>1.45</td> <td>1.5</td> <td>1.55</td> </tr> </tbody> </table> <p>Due to the current load capability of the contact elements, the following limits must not be exceeded:</p> <table border="1"> <thead> <tr> <th>CAPACITOR DIAMETER</th> <th>35mm</th> <th>51mm</th> <th>63mm</th> <th>76mm</th> <th>90mm</th> </tr> </thead> <tbody> <tr> <td>Maximum current</td> <td>20A</td> <td>30A</td> <td>40A</td> <td>50A</td> <td>70A</td> </tr> </tbody> </table>		FREQUENCY	50Hz	100Hz	500Hz	1000Hz	>10kHz	MULTIPLIER	0.88	1.0	1.45	1.5	1.55	CAPACITOR DIAMETER	35mm	51mm	63mm	76mm	90mm	Maximum current	20A	30A	40A	50A	70A
FREQUENCY	50Hz	100Hz	500Hz	1000Hz	>10kHz																					
MULTIPLIER	0.88	1.0	1.45	1.5	1.55																					
CAPACITOR DIAMETER	35mm	51mm	63mm	76mm	90mm																					
Maximum current	20A	30A	40A	50A	70A																					
<b>Insulation Resistance</b>	At 100V DC for 1 min is >100 MΩ across insulating sleeve and terminals.																									
<b>Vibration Resistance</b>	Frequency range: 10 Hz to 55 Hz, amplitude 0.75 mm Capacitor length ≤ 130 : max acceleration 10G for 3x2 h Capacitor length > 130 : max acceleration 5G for 3x0.5 h																									
<b>Life test</b>	After 2,000 hours application of rated voltage at 85°C capacitors meet characteristics aside	<table border="1"> <tr> <td>Cap change</td> <td>≤ 10%</td> </tr> <tr> <td>tan δ</td> <td>≤ 130%</td> </tr> <tr> <td>Leakage current (I<sub>L</sub>)</td> <td>&lt; initial limit</td> </tr> <tr> <td>Impedance (Z)</td> <td>≤ 130%</td> </tr> </table>	Cap change	≤ 10%	tan δ	≤ 130%	Leakage current (I <sub>L</sub> )	< initial limit	Impedance (Z)	≤ 130%																
Cap change	≤ 10%																									
tan δ	≤ 130%																									
Leakage current (I <sub>L</sub> )	< initial limit																									
Impedance (Z)	≤ 130%																									
<b>Shelf life</b>	After leaving capacitors under no load for 500 hours at 85°C, when restored at 20°C meet specifications aside	<table border="1"> <tr> <td>Cap change</td> <td>≤ ±15%</td> </tr> <tr> <td>tan δ</td> <td>≤ 150%</td> </tr> <tr> <td>Leakage current (I<sub>L</sub>)</td> <td>&lt; initial limit</td> </tr> </table>	Cap change	≤ ±15%	tan δ	≤ 150%	Leakage current (I <sub>L</sub> )	< initial limit																		
Cap change	≤ ±15%																									
tan δ	≤ 150%																									
Leakage current (I <sub>L</sub> )	< initial limit																									
<b>Self inductance</b>	Approx. 20 nH																									
<b>Reference standards</b>	CECC 30.300 IEC 60384-4 LONG LIFE GRADE																									



## K07 TYPE STANDARD RATINGS

**RATED  
VOLTAGE  
VDC**

**160V**

Cap µF	Ø x L mm	Tan δ MAX 120 Hz 20°C	ESR TYP m Ω 120 Hz 20°C	Ir a.c. A max 120 Hz 40°C	Ir a.c. A max 120 Hz 85°C	PART NUMBER stud and insert style excluded
6800	51x96	0.15	21	23.4	10.9	K07160682__M0G096
8200	51x105	0.15	18	27.5	12.8	K07160822__M0G105
10000	51x115	0.15	13	29.0	13.5	K07160103__M0G115
10000	63x96	0.15	13	26.6	12.4	K07160103__M0H096
12000	51x130	0.15	13	34.1	15.8	K07160123__M0G130
15000	63x105	0.15	13	31.3	14.6	K07160153__M0H105
15000	63x115	0.15	13	32.4	15.1	K07160153__M0H115
18000	63x130	0.15	12	38.1	17.7	K07160183__M0H130
22000	63x143	0.20	10	48.1	22.4	K07160223__M0H143
22000	76x105	0.20	10	48.1	22.4	K07160223__M0J105
22000	76x115	0.20	10	49.7	23.1	K07160223__M0J115
27000	76x130	0.20	10	54.4	25.3	K07160273__M0J130
33000	76x143	0.20	8	65.7	30.6	K07160333__M0J143
47000	76x214	0.25	7	81.5	37.6	K07160473__M0J214
47000	76x220	0.25	7	81.5	37.6	K07160473__M0J220

**RATED  
VOLTAGE  
VDC**

**200V**

Cap µF	Ø x L mm	Tan δ MAX 120 Hz 20°C	ESR TYP m Ω 120 Hz 20°C	Ir a.c. A max 120 Hz 40°C	Ir a.c. A max 120 Hz 85°C	PART NUMBER stud and insert style excluded
5600	51x96	0.15	27	23.0	10.7	K07200562__M0G096
6800	51x105	0.15	22	27.0	12.6	K07200682__M0G105
6800	63x96	0.15	22	26.4	12.3	K07200682__M0H096
8200	51x115	0.15	18	28.5	13.2	K07200822__M0G115
10000	51x130	0.15	13	33.4	15.5	K07200103__M0G130
10000	63x105	0.15	13	31.3	14.6	K07200103__M0H105
12000	63x115	0.15	13	31.9	14.8	K07200123__M0H115
14000	63x130	0.15	12	37.6	17.5	K07200143__M0H130
15000	63x143	0.15	12	40.4	18.8	K07200153__M0H143
15000	76x105	0.15	12	40.4	18.8	K07200153__M0J105
18000	76x115	0.15	12	44.5	20.7	K07200183__M0J115
22000	76x130	0.18	10	50.0	23.4	K07200223__M0J130
27000	76x143	0.18	9	64.6	30.0	K07200273__M0J143
33000	76x214	0.22	8	75.7	35.2	K07200333__M0J214
33000	76x220	0.22	8	75.7	35.2	K07200333__M0J220

## K07 TYPE STANDARD RATINGS

**RATED  
VOLTAGE  
VDC**

**250V**

Cap $\mu\text{F}$	$\varnothing$ x L mm	Tan $\delta$ MAX 120 Hz 20°C	ESR TYP m $\Omega$ 120 Hz 20°C	Ir a.c. A max 120 Hz 40°C	Ir a.c. A max 120 Hz 85°C	PART NUMBER stud and insert style excluded
3900	51x96	0.15	32	22.0	10.2	K07250392__M0G096
4700	51x105	0.15	25	25.7	11.9	K07250472__M0G105
5600	51x115	0.15	24	27.5	12.8	K07250562__M0G115
6800	51x130	0.15	19	32.1	14.9	K07250682__M0G130
4700	63x96	0.15	30	25.7	12.0	K07250472__M0H096
8200	63x105	0.15	22	30.9	14.4	K07250822__M0H105
10000	63x115	0.15	20	31.6	14.7	K07250103__M0H115
12000	63x130	0.15	19	37.1	17.2	K07250123__M0H130
12000	63x143	0.15	19	45.8	21.3	K07250123__M0H143
12000	76x105	0.15	19	45.8	21.3	K07250123__M0J105
12000	76x115	0.15	19	47.4	22.0	K07250123__M0J115
15000	76x130	0.15	16	46.3	21.5	K07250153__M0J130
18000	76x143	0.20	10	47.6	22.1	K07250183__M0J143
27000	76x214	0.25	8	70.0	32.6	K07250273__M0J214
27000	76x220	0.25	8	70.0	32.6	K07250273__M0J220

**RATED  
VOLTAGE  
VDC**

**315V**

Cap $\mu\text{F}$	$\varnothing$ x L mm	Tan $\delta$ MAX 120 Hz 20°C	ESR TYP m $\Omega$ 120 Hz 20°C	Ir a.c. A max 120 Hz 40°C	Ir a.c. A max 120 Hz 85°C	PART NUMBER stud and insert style excluded
2200	51x96	0.15	31	19.4	9.0	K07315222__M0G096
2700	51x105	0.15	24	22.6	10.5	K07315272__M0G105
2700	51x115	0.15	24	23.4	10.9	K07315272__M0G115
3300	51x130	0.15	20	27.3	12.7	K07315332__M0G130
2700	63x96	0.15	24	23.2	10.8	K07315272__M0H096
3900	63x105	0.15	20	28.1	13.1	K07315392__M0H105
4700	63x115	0.15	20	29.8	13.9	K07315472__M0H115
5600	63x130	0.15	17	34.7	16.1	K07315562__M0H130
6800	63x143	0.15	14	39.8	18.5	K07315682__M0H143
5600	76x105	0.15	14	39.0	18.1	K07315562__M0J105
6800	76x115	0.15	12	42.5	19.8	K07315682__M0J115
8200	76x130	0.15	10	49.2	22.9	K07315822__M0J130
10000	76x143	0.15	8	49.4	23.0	K07315103__M0J143
15000	76x214	0.20	8	67.6	31.4	K07315153__M0J214
15000	76x220	0.25	8	67.6	31.4	K07315153__M0J220

## K07 TYPE STANDARD RATINGS

Cap $\mu\text{F}$	$\varnothing \times L$ mm	Tan $\delta$ MAX 120 Hz 20°C	ESR TYP m $\Omega$ 120 Hz 20°C	Ir a.c. A max 120 Hz 40°C	Ir a.c. A max 120 Hz 85°C	PART NUMBER stud and insert style excluded
1800	51x96	0.15	33	18.8	8.7	K07350182__M0G096
2200	51x105	0.15	26	21.8	10.1	K07350222__M0G105
2700	51x115	0.15	23	23.9	11.1	K07350272__M0G115
3300	51x130	0.15	19	27.9	13.0	K07350332__M0G130
3300	63x96	0.15	27	23.5	10.9	K07350332__M0H096
3900	63x105	0.15	20	27.8	12.9	K07350392__M0H105
3900	63x115	0.15	20	28.8	13.4	K07350392__M0H115
4700	63x130	0.15	17	33.6	15.6	K07350472__M0H130
5600	63x143	0.15	13	39.8	18.5	K07350562__M0H143
5600	76x105	0.15	13	39.8	18.5	K07350562__M0J105
5600	76x115	0.15	13	41.1	19.2	K07350562__M0J115
6800	76x130	0.15	12	41.1	19.2	K07350682__M0J130
8200	76x143	0.15	12	45.2	21.0	K07350822__M0J143
10000	76x143	0.15	12	46.3	21.5	K07350103__M0J143
12000	76x214	0.20	8	66.1	30.7	K07350123__M0J214
12000	76x220	0.25	8	66.1	30.7	K07350123__M0J220

**RATED  
VOLTAGE  
VDC**

**350V**

Cap $\mu\text{F}$	$\varnothing \times L$ mm	Tan $\delta$ MAX 120 Hz 20°C	ESR TYP m $\Omega$ 120 Hz 20°C	Ir a.c. A max 120 Hz 40°C	Ir a.c. A max 120 Hz 85°C	PART NUMBER stud and insert style excluded
2200	51x130	0.20	77	17.37	6.53	K07400222__M0G130
2200	63x96	0.20	84	17.03	6.40	K07400222__M0H096
2700	63x96	0.20	75	19.02	7.15	K07400272__M0H096
3300	63x105	0.20	59	22.75	8.40	K07400332__M0H105
3300	63x115	0.20	59	22.75	8.55	K07400332__M0H115
3900	63x130	0.20	49	26.06	9.80	K07400392__M0H130
4700	76x105	0.20	41	28.60	10.60	K07400472__M0J105
4700	76x115	0.20	41	28.60	10.75	K07400472__M0J115
5600	76x130	0.20	34	32.45	12.20	K07400562__M0J130
6800	76x143	0.20	24	38.84	14.50	K07400682__M0J143
6800	76x155	0.20	24	38.84	14.60	K07400682__M0J155
8200	90x157	0.20	22	44.74	16.82	K07400822__M0L157
10000	90x157	0.20	19	49.29	18.53	K07400103__M0L157
12000	90x196	0.20	16	59.87	22.51	K07400123__M0L196
15000	90x220	0.20	13	69.90	26.28	K07400153__M0L220

**RATED  
VOLTAGE  
VDC**

**400V**

## K07 TYPE STANDARD RATINGS

Cap $\mu\text{F}$	$\varnothing \times L$ mm	Tan $\delta$ MAX 120 Hz 20°C	ESR TYP m $\Omega$ 120 Hz 20°C	Ir a.c. A max 120 Hz 40°C	Ir a.c. A max 120 Hz 85°	PART NUMBER stud and insert style excluded
1800	51x130	0.20	84	16.25	6.11	K07450182__M0G130
2200	63x96	0.20	80	17.35	6.52	K07450222__M0H096
2700	63x105	0.20	62	20.74	7.60	K07450272__M0H105
2700	63x115	0.20	62	20.74	7.80	K07450272__M0H115
3300	63x130	0.20	51	24.22	9.11	K07450332__M0H130
3900	76x105	0.20	44	26.25	9.70	K07450392__M0J105
3900	76x115	0.20	44	26.25	9.87	K07450392__M0J115
4700	76x130	0.20	36	30.90	11.62	K07450472__M0J130
5600	76x143	0.20	30	35.69	13.22	K07450562__M0J143
5600	76x155	0.20	30	35.69	13.42	K07450562__M0J155
6800	90x157	0.20	25	41.36	15.55	K07450682__M0L157
8200	90x157	0.20	22	45.09	16.95	K07450822__M0L157
10000	90x196	0.20	18	54.75	20.60	K07450103__M0L196
12000	90x220	0.20	15	63.15	23.75	K07450123__M0L220

**RATED  
VOLTAGE  
VDC**

**450V**

PLEASE TO CONTACT OUR TECHNICAL SERVICE FOR MORE INFORMATION OR SPEC-IN ANALYSIS.

## LOAD LIFE K07

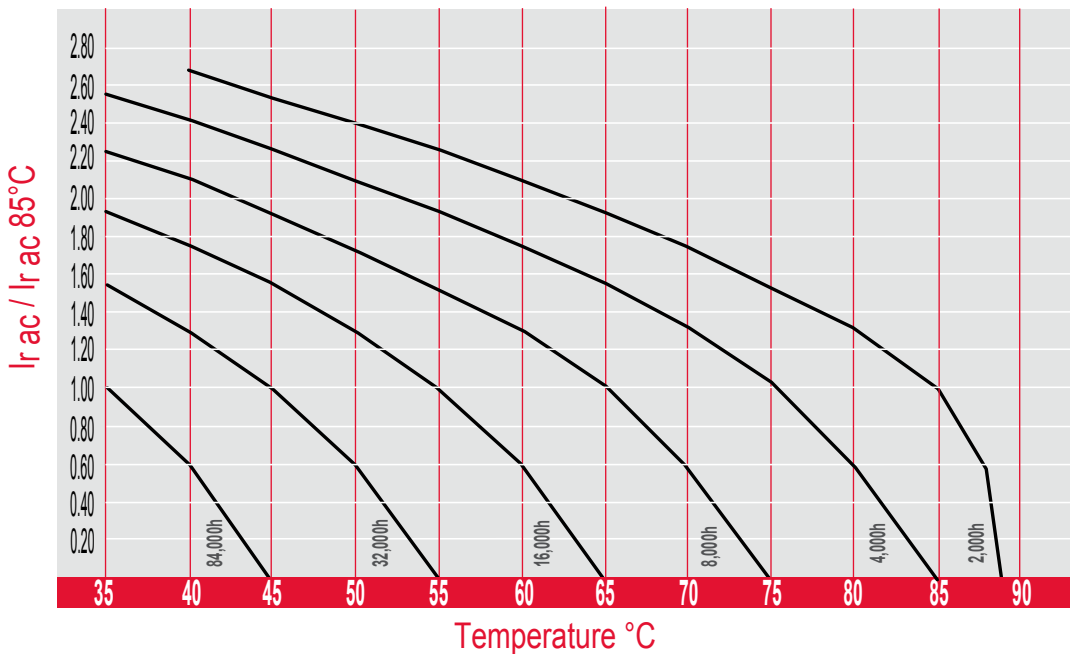

The graphs shows a typical trend of the standard capacitor load life. For a more accurate calculation of the load life for a specific capacitor, please use our calculator on the website [www.kendeil.com](http://www.kendeil.com) or enquiry our technical service.

# K11 TYPE -40°C +85°C 15000H

RoHS Compliant

- Surge-proof capacitor in aluminium can with insulation sleeve.
- To be mounted with ring clips or with threaded stud
- Design optimized for parallel connection and high density of energy

## APPLICATIONS

Energy Storage, Bulk.

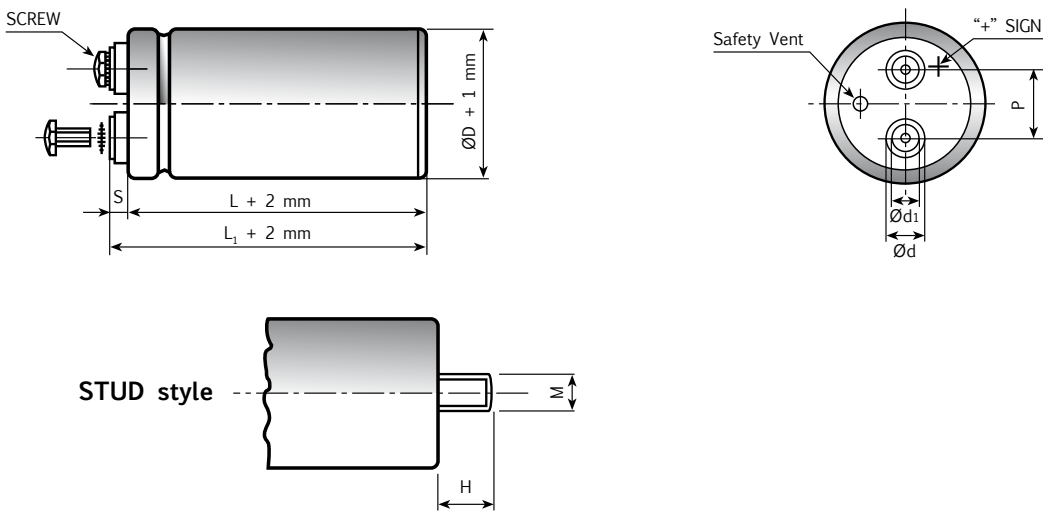

Diagram of dimensions (unit=mm)  
Insert and screw threads: Metric (mm), UNF (inches)

ØD	d	d1	P	STUD		INSERT	SCREW	L <sub>1</sub> -L[-1+3]	S[-1+1]	INSERT STYLE CODE
				M	H					
35	11	7.9	12.7	M8	12	M5	5MA x 9.5	2.5	5	O
51	18.5	13	22.7	M12	16	M5	5MA x 9.5	2.5	5	H
63	18.5	13	28.6	M12	16	M5	5MA x 9.5	2.5	5	H
63	17.3	17.3	28.6	M12	16	UNF 1/4-28 Low Post	1/4-28 x 3/8"	3	4	W
63	17.3	17.3	28.6	M12	16	UNF 1/4-28 High Post	1/4-28 x 1/2"	6	7	R
63	7.9	7.9	28.6	M12	16	UNF 10-32 Low Post	10-32 x 1/4"	2	2.5	Z
63	12	7.9	28.6	M12	16	UNF 10-32 High Post	10-32 x 3/8"	6	7	U
76	18.5	13	31.8	M12	16	M5	5MA x 9.5	2.5	5	H
76	18.5	13	31.8	M12	16	M5	5MA x 9.5	2.5	7	L
76	23.2	17.7	31.8	M12	16	M6	6MA x 10	4.5	7	6
76	17.3	17.3	31.8	M12	16	UNF 1/4-28 Low Post	1/4-28 x 3/8"	3	4	W
76	17.3	17.3	31.8	M12	16	UNF 1/4-28 High Post	1/4-28 x 1/2"	6	7	R
76	7.9	7.9	31.8	M12	16	UNF 10-32 Low Post	10-32 x 1/4"	2	2.5	Z
76	12	7.9	31.8	M12	16	UNF 10-32 High Post	10-32 x 3/8"	6	7	U
90	23.2	17.7	31.8	M12	16	M6	6MA x 10	4.5	7	H

## SPECIFICATIONS

<b>Temperature Range</b>	Operating: -40°C +85°C Storage : Preferably below +25°C, not exceeding +40°C																																			
<b>Rated Voltage Range (V<sub>r</sub>)</b>	from 350V to 450V DC																																			
<b>Surge Voltage (V<sub>p</sub>)</b>	V <sub>p</sub> = 1.10 V <sub>r</sub> (V <sub>r</sub> ≤ 250V DC)																																			
<b>Rated Capacitance Range</b>	from 12000 μF to 34000 μF																																			
<b>Capacitance Tolerance</b>	±20% at 100 Hz, 20°C [M class IEC-62] on request: -10% +30% at 100 Hz, 20°C [Q class IEC-62]																																			
<b>Leakage Current (I<sub>L</sub>)</b> (mA, 5 min, 20°C)	max I <sub>L</sub> = 0.006 C <sub>r</sub> V <sub>r</sub> + 4 μA At 85°C max I <sub>L</sub> = 0.04 C <sub>r</sub> V <sub>r</sub> μA	Kendeil product limit: I <sub>L</sub> = 0.003 C <sub>r</sub> V <sub>r</sub>																																		
<b>Ripple current (I<sub>r</sub>)</b>	Refer to table at 85°C and 100Hz: <table border="1" style="width: 100%; border-collapse: collapse;"> <thead> <tr> <th>FREQUENCY</th> <th>50Hz</th> <th>100 Hz</th> <th>500Hz</th> <th>1000Hz</th> <th>&gt;10kHz</th> </tr> </thead> <tbody> <tr> <td>MULTIPLIER</td> <td>0.8</td> <td>1.0</td> <td>1.2</td> <td>1.3</td> <td>1.5</td> </tr> </tbody> </table> <table border="1" style="width: 100%; border-collapse: collapse;"> <thead> <tr> <th>AMBIENT TEMP</th> <th>35°C</th> <th>45°C</th> <th>55°C</th> <th>65°C</th> <th>75°C</th> <th>85°C</th> <th>95°C</th> </tr> </thead> <tbody> <tr> <td>MULTIPLIER</td> <td>2.2</td> <td>2.1</td> <td>1.8</td> <td>1.6</td> <td>1.4</td> <td>1.0</td> <td>0.5</td> </tr> </tbody> </table> Due to the current load capability of the contact elements, the following limits must not be exceeded: <table border="1" style="width: 100%; border-collapse: collapse;"> <thead> <tr> <th>CAPACITOR DIAMETER</th> <th>76mm</th> <th>90mm</th> </tr> </thead> <tbody> <tr> <td>Maximum current</td> <td>50A</td> <td>70A</td> </tr> </tbody> </table>		FREQUENCY	50Hz	100 Hz	500Hz	1000Hz	>10kHz	MULTIPLIER	0.8	1.0	1.2	1.3	1.5	AMBIENT TEMP	35°C	45°C	55°C	65°C	75°C	85°C	95°C	MULTIPLIER	2.2	2.1	1.8	1.6	1.4	1.0	0.5	CAPACITOR DIAMETER	76mm	90mm	Maximum current	50A	70A
FREQUENCY	50Hz	100 Hz	500Hz	1000Hz	>10kHz																															
MULTIPLIER	0.8	1.0	1.2	1.3	1.5																															
AMBIENT TEMP	35°C	45°C	55°C	65°C	75°C	85°C	95°C																													
MULTIPLIER	2.2	2.1	1.8	1.6	1.4	1.0	0.5																													
CAPACITOR DIAMETER	76mm	90mm																																		
Maximum current	50A	70A																																		
<b>Insulation Resistance</b>	At 100V DC for 1 min is >100 MΩ across insulating sleeve and terminals.																																			
<b>Vibration Resistance</b>	Frequency range: 10 Hz to 55 Hz, amplitude 0.75 mm max acceleration 10G for 3x2 h																																			
<b>Life test</b>	After 2,000 hours application of rated voltage at 85°C capacitors meet characteristics aside	Cap change ≤ 10% tan δ ≤ 130% Leakage current (I <sub>L</sub> ) < initial limit Impedance (Z) ≤ 130%																																		
<b>Shelf life</b>	After leaving capacitors under no load for 500 hours at 85°C when restored at 20°C meet specifications aside	Cap change ≤ ±15% tan δ ≤ 150% Leakage current (I <sub>L</sub> ) < initial limit																																		
<b>Useful life</b> (V <sub>n</sub> , Temp rated I ripple applied)	> 15000 h at 85°C																																			
<b>Failure percentage</b> <b>Failure rate</b>	≤ 1% (during useful life) ≤ 33 fit (33 10 <sup>-9</sup> /h)																																			
<b>Self inductance</b>	Approx. 20 nH																																			
<b>Reference standards</b>	CECC 30.300 IEC 60384-4 LONG LIFE GRADE																																			

## K11 TYPE STANDARD RATINGS

Cap $\mu\text{F}$	$\varnothing \times \text{L}$ mm	Tan $\delta$ MAX 100 Hz 20°C	I <sub>r</sub> a.c. A max 100 Hz 85°C	PART NUMBER stud and insert style excluded
19000	76x214	0.25	18.0	K11350193__M0J214
20000	76x240	0.25	18.0	K11350203__M0J240
22000	76x214	0.25	18.4	K11350223__M0J214
24000	76x240	0.25	18.5	K11350243__M0J240
27000	90x220	0.25	21.0	K11350273__M0L220
30000	90x220	0.25	21.4	K11350303__M0L220
30000	90x240	0.25	22.0	K11350303__M0L240
34000	90x240	0.25	22.5	K11350343__M0L240

**RATED  
VOLTAGE  
VDC**

**350V**

Cap $\mu\text{F}$	$\varnothing \times \text{L}$ mm	Tan $\delta$ MAX 100 Hz 20°C	I <sub>r</sub> a.c. A max 100 Hz 85°C	PART NUMBER stud and insert style excluded
15000	76x214	0.25	16.0	K11400153__M0J214
16000	76x240	0.25	17.7	K11400163__M0J240
18000	76x214	0.25	16.3	K11400183__M0J214
20000	76x240	0.25	18.1	K11400203__M0J240
21000	90x220	0.25	21.5	K11400213__M0L220
23000	90x240	0.25	23.2	K11400233__M0L240
25000	90x220	0.25	21.9	K11400253__M0L220
29000	90x240	0.25	23.7	K11400293__M0L240

**RATED  
VOLTAGE  
VDC**

**400V**

Cap $\mu\text{F}$	$\varnothing \times \text{L}$ mm	Tan $\delta$ MAX 100 Hz 20°C	I <sub>r</sub> a.c. A max 100 Hz 85°C	PART NUMBER stud and insert style excluded
12000	76x214	0.20	16.0	K11450123__M0J214
13000	76x240	0.20	17.5	K11450133__M0J240
15000	76x214	0.20	16.4	K11450153__M0J214
16000	76x240	0.20	18.0	K11450163__M0J240
17000	90x220	0.20	20.9	K11450173__M0L220
18000	90x240	0.20	22.5	K11450183__M0L240
20000	90x220	0.20	21.6	K11450203__M0L220
23000	90x240	0.20	23.1	K11450233__M0L240

**RATED  
VOLTAGE  
VDC**

**450V**

# K21 TYPE -40°C +85°C 15000H

RoHS Compliant

- Surge-proof capacitor in aluminium can with insulation sleeve.
- To be mounted with ring clips or with threaded stud
- Design optimized for high ripple current applications

## APPLICATIONS

Designed for professional application. Switch mode power suppliers, high ripple current converters, motor drives.

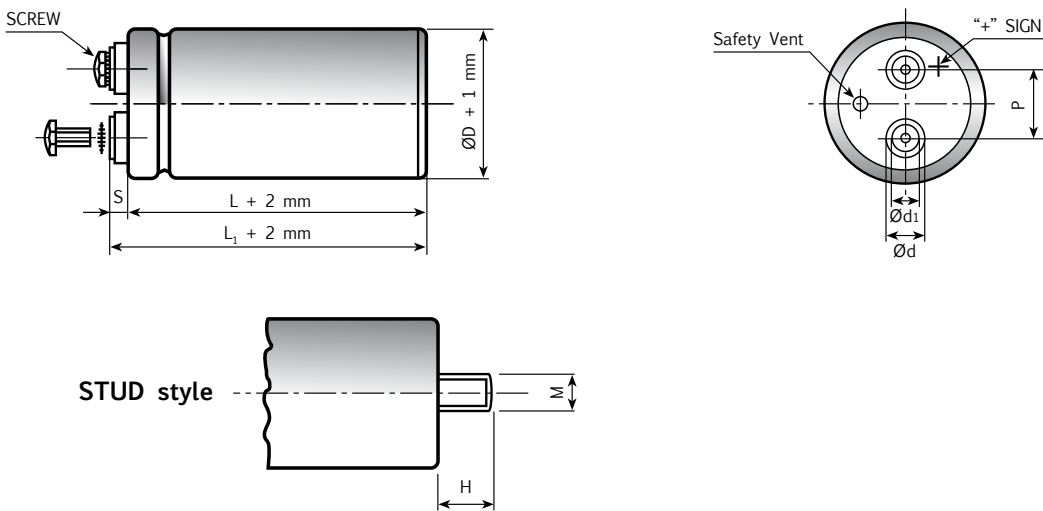

Diagram of dimensions (unit=mm)  
Insert and screw threads: Metric (mm), UNF (inches)

ØD	d	d1	P	STUD		INSERT	SCREW	L <sub>1</sub>	-L[-1+3]	S[-1+1]	INSERT STYLE CODE
				M	H						
35	11	7.9	12.7	M8	12	M5	5MA x 9.5	2.5		5	O
51	18.5	13	22.7	M12	16	M5	5MA x 9.5	2.5		5	H
63	18.5	13	28.6	M12	16	M5	5MA x 9.5	2.5		5	H
63	17.3	17.3	28.6	M12	16	UNF 1/4-28 Low Post	1/4-28 x 3/8"	3		4	W
63	17.3	17.3	28.6	M12	16	UNF 1/4-28 High Post	1/4-28 x 1/2"	6		7	R
63	7.9	7.9	28.6	M12	16	UNF 10-32 Low Post	10-32 x 1/4"	2		2.5	Z
63	12	7.9	28.6	M12	16	UNF 10-32 High Post	10-32 x 3/8"	6		7	U
76	18.5	13	31.8	M12	16	M5	5MA x 9.5	2.5		5	H
76	18.5	13	31.8	M12	16	M5	5MA x 9.5	2.5		7	L
76	23.2	17.7	31.8	M12	16	M6	6MA x 10	4.5		7	6
76	17.3	17.3	31.8	M12	16	UNF 1/4-28 Low Post	1/4-28 x 3/8"	3		4	W
76	17.3	17.3	31.8	M12	16	UNF 1/4-28 High Post	1/4-28 x 1/2"	6		7	R
76	7.9	7.9	31.8	M12	16	UNF 10-32 Low Post	10-32 x 1/4"	2		2.5	Z
76	12	7.9	31.8	M12	16	UNF 10-32 High Post	10-32 x 3/8"	6		7	U
90	23.2	17.7	31.8	M12	16	M6	6MA x 10	4.5		7	H



## SPECIFICATIONS

<b>Temperature Range</b>	Operating: -40°C +85°C Storage : Preferably below +25°C, not exceeding +40°C	[Environmental classification 40/85/56 IEC-68]																																						
<b>Rated Voltage Range (V<sub>r</sub>)</b>	from 350V to 450V DC																																							
<b>Surge Voltage (V<sub>p</sub>)</b>	V <sub>p</sub> = 1.10 V <sub>r</sub>																																							
<b>Rated Capacitance Range</b>	from 1200 µF to 15000 µF																																							
<b>Capacitance Tolerance</b>	±20% at 100 Hz, 20°C [M class IEC-62] on request: -10% +30% at 100 Hz, 20°C [Q class IEC-62]																																							
<b>Leakage Current (I<sub>L</sub>)</b> (mA, 5 min, 20°C)	max I <sub>L</sub> = 0.006 C <sub>r</sub> V <sub>r</sub> + 4 µA At 85°C max I <sub>L</sub> = 0.04 C <sub>r</sub> V <sub>r</sub> µA	Kendeil product limit: I <sub>L</sub> = 0.003 C <sub>r</sub> V <sub>r</sub>																																						
<b>Ripple current (I<sub>r</sub>)</b>	Refer to table at 85°C and 100Hz: <table border="1" style="width: 100%; border-collapse: collapse;"> <thead> <tr> <th>FREQUENCY</th> <th>50Hz</th> <th>100 Hz</th> <th>500Hz</th> <th>1000Hz</th> <th>&gt;10kHz</th> </tr> </thead> <tbody> <tr> <td>MULTIPLIER</td> <td>0.8</td> <td>1.0</td> <td>1.2</td> <td>1.3</td> <td>1.5</td> </tr> </tbody> </table> <table border="1" style="width: 100%; border-collapse: collapse;"> <thead> <tr> <th>AMBIENT TEMP</th> <th>35°C</th> <th>45°C</th> <th>55°C</th> <th>65°C</th> <th>75°C</th> <th>85°C</th> <th>95°C</th> </tr> </thead> <tbody> <tr> <td>MULTIPLIER</td> <td>2.2</td> <td>2.1</td> <td>1.8</td> <td>1.6</td> <td>1.4</td> <td>1.0</td> <td>0.5</td> </tr> </tbody> </table> Maximum internal temperature 98°C  Due to the current load capability of the contact elements, the following limits must not be exceeded: <table border="1" style="width: 100%; border-collapse: collapse;"> <thead> <tr> <th>CAPACITOR DIAMETER</th> <th>51mm</th> <th>63mm</th> <th>76mm</th> <th>90mm</th> </tr> </thead> <tbody> <tr> <td>Maximum current</td> <td>30A</td> <td>40A</td> <td>50A</td> <td>70A</td> </tr> </tbody> </table>		FREQUENCY	50Hz	100 Hz	500Hz	1000Hz	>10kHz	MULTIPLIER	0.8	1.0	1.2	1.3	1.5	AMBIENT TEMP	35°C	45°C	55°C	65°C	75°C	85°C	95°C	MULTIPLIER	2.2	2.1	1.8	1.6	1.4	1.0	0.5	CAPACITOR DIAMETER	51mm	63mm	76mm	90mm	Maximum current	30A	40A	50A	70A
FREQUENCY	50Hz	100 Hz	500Hz	1000Hz	>10kHz																																			
MULTIPLIER	0.8	1.0	1.2	1.3	1.5																																			
AMBIENT TEMP	35°C	45°C	55°C	65°C	75°C	85°C	95°C																																	
MULTIPLIER	2.2	2.1	1.8	1.6	1.4	1.0	0.5																																	
CAPACITOR DIAMETER	51mm	63mm	76mm	90mm																																				
Maximum current	30A	40A	50A	70A																																				
<b>Insulation Resistance</b>	At 100V DC for 1 min is >100 MΩ across insulating sleeve and terminals.																																							
<b>Vibration Resistance</b>	Frequency range: 10 Hz to 55 Hz, amplitude 0.75 mm Capacitor length ≤ 143 : max acceleration 10g for 3x2 h Capacitor length > 143 : max acceleration 5g for 3x0.5 h																																							
<b>Life test</b>	After 2,000 hours application of rated voltage at 85°C capacitors meet characteristics aside	Cap change ≤ 10% tan δ ≤ 130% Leakage current (I <sub>L</sub> ) < initial limit Impedance (Z) ≤ 130%																																						
<b>Shelf life</b>	After leaving capacitors under no load for 500 hours at 85°C when restored at 20°C meet specifications aside	Cap change ≤ ±15% tan δ ≤ 150% Leakage current (I <sub>L</sub> ) < initial limit																																						
<b>Useful life</b> (V <sub>n</sub> , Temp rated I ripple applied)	> 200000 h at 40°C > 15000 h at 85°C																																							
<b>Failure percentage</b> <b>Failure rate</b>	≤ 1% (during useful life) ≤ 33 fit (33 10 <sup>-9</sup> /h)																																							
<b>Self inductance</b>	Approx. 20 nH																																							
<b>Reference standards</b>	CECC 30.300 IEC 60384-4 LONG LIFE GRADE																																							

## K21 TYPE STANDARD RATINGS

**RATED  
VOLTAGE  
VDC**

**350V**

Cap µF	Ø x L mm	Tan δ MAX 100 Hz 20°C	ESR TYP mΩ 100 Hz 20°C	Z TYP mΩ 10 kHz 20°C	Ir a.c. A max 100 Hz 85°C	PART NUMBER stud and insert style excluded
1500	51x79	0.08	40	24	9.30	K21350152_M0G079
1500	51x105	0.08	40	24	10.10	K21350152_M0G105
2200	51x105	0.08	29	20	11.90	K21350222_M0G105
2200	63x105	0.08	29	20	14.50	K21350222_M0H105
2200	76x79	0.08	29	20	14.20	K21350222_M0J079
2200	76x98	0.08	29	20	15.30	K21350222_M0J098
3300	63x105	0.08	17	13	17.70	K21350332_M0H105
3300	76x79	0.08	21	16	16.00	K21350332_M0J079
3300	76x105	0.08	20	13	18.80	K21350332_M0J105
4700	76x105	0.09	13	10	22.10	K21350472_M0J105
4700	76x143	0.09	13	10	25.80	K21350472_M0J143
4700	90x98	0.09	14	11	22.50	K21350472_M0L098
5600	76x143	0.09	10	8	27.40	K21350562_M0J143
6800	76x143	0.09	9.5	7	30.00	K21350682_M0J143
6800	90x145	0.09	9.5	7	32.20	K21350682_M0L145
8200	90x145	0.09	8.5	6	35.30	K21350822_M0L145
10000	76x214	0.09	7	5	41.80	K21350103_M0J214
10000	90x145	0.10	7	5	36.70	K21350103_M0L145
12000	76x214	0.10	7	5	41.90	K21350123_M0J214
15000	90x220	0.10	5.5	4	52.50	K21350153_M0L220

**RATED  
VOLTAGE  
VDC**

**400V**

Cap µF	Ø x L mm	Tan δ MAX 100 Hz 20°C	ESR TYP mΩ 100 Hz 20°C	Z TYP mΩ 10 kHz 20°C	Ir a.c. A max 100 Hz 85°C	PART NUMBER stud and insert style excluded
1500	51x79	0.08	40	24	9.30	K21400152_M0G079
1500	51x105	0.08	40	24	10.10	K21400152_M0G105
2200	51x105	0.08	29	20	11.90	K21400222_M0G105
2200	76x79	0.08	29	20	14.20	K21400222_M0J079
2200	76x98	0.08	29	20	15.30	K21400222_M0J098
3300	63x105	0.08	17	13	17.70	K21400332_M0H105
3300	76x79	0.08	21	16	16.00	K21400332_M0J079
3300	76x98	0.08	21	16	17.20	K21400332_M0J098
3300	76x105	0.08	20	13	18.80	K21400332_M0J105
3900	76x105	0.08	16	11	20.90	K21400392_M0J105
4400	90x98	0.08	14	11	22.20	K21400442_M0L098
4700	76x105	0.09	13	10	22.10	K21400472_M0J105
4700	76x143	0.09	13	10	25.80	K21400472_M0J143
4700	90x98	0.09	13	11	22.50	K21400472_M0L098
5600	76x143	0.09	10	8	27.40	K21400562_M0J143
6800	76x143	0.09	9.5	7	30.00	K21400682_M0J143
6800	90x145	0.09	9.5	7	32.20	K21400682_M0L145
8200	90x145	0.09	8.5	6	35.30	K21400822_M0L145
10000	76x214	0.09	7	5	41.80	K21400103_M0J214
10000	90x145	0.10	7	5	36.70	K21400103_M0L145
14000	90x220	0.10	6	5	50.10	K21400143_M0L220
15000	90x220	0.10	5.5	4	52.50	K21400153_M0L220

## K21 TYPE STANDARD RATINGS

Cap µF	Ø x L mm	Tan δ MAX 100 Hz 20°C	ESR TYP mΩ 100 Hz 20°C	Z TYP mΩ 10 kHz 20°C	Ir a.c. A max 100 Hz 85°C	PART NUMBER stud and insert style excluded
1500	51x79	0.08	40	24	9.30	K21420152_M0G079
1500	51x105	0.08	40	24	10.10	K21420152_M0G105
2200	51x105	0.08	29	20	11.90	K21420222_M0G105
2200	76x79	0.08	29	20	14.20	K21420222_M0J079
2200	76x98	0.08	29	20	15.30	K21420222_M0J098
3300	63x105	0.08	17	13	17.70	K21420332_M0H105
3300	76x79	0.08	21	16	16.00	K21420332_M0J079
3300	76x98	0.08	21	16	17.20	K21420332_M0J098
3300	76x105	0.08	20	13	18.80	K21420332_M0J105
3900	76x105	0.08	16	11	20.90	K21420392_M0J105
4400	90x98	0.08	16	12	22.20	K21420442_M0L098
4700	76x105	0.09	13	10	22.10	K21420472_M0J105
4700	76x143	0.09	13	10	25.80	K21420472_M0J143
4700	90x98	0.09	13	11	22.50	K21420472_M0L098
5600	76x143	0.09	10	8	27.40	K21420562_M0J143
6800	76x143	0.09	9.5	7	30.00	K21420682_M0J143
6800	90x145	0.09	9.5	7	32.20	K21420682_M0L145
8200	90x145	0.09	8.5	6	35.30	K21420822_M0L145
10000	76x214	0.09	7	5	41.80	K21420103_M0J214
10000	90x145	0.10	7	5	36.70	K21420103_M0L145
14000	90x220	0.10	6	5	50.10	K21420143_M0L220
15000	90x220	0.10	5.5	4	52.50	K21420153_M0L220

**RATED  
VOLTAGE  
VDC**

**420V**

Cap µF	Ø x L mm	Tan δ MAX 100 Hz 20°C	ESR TYP mΩ 100 Hz 20°C	Z TYP mΩ 10 kHz 20°C	Ir a.c. A max 100 Hz 85°C	PART NUMBER stud and insert style excluded
1200	51x79	0.08	60	36	8.90	K21450122_M0G079
1200	51x105	0.08	60	36	9.49	K21450122_M0G105
1500	51x105	0.08	49	29	10.70	K21450152_M0G105
2200	63x105	0.08	30	17	15.40	K21450222_M0H105
2200	76x79	0.08	32	20	14.30	K21450222_M0J079
2200	76x98	0.08	32	20	15.40	K21450222_M0J098
3300	76x105	0.08	26	16	18.80	K21450332_M0J105
3300	90x98	0.08	26	16	20.50	K21450332_M0L098
3900	76x105	0.08	21	13	21.10	K21450392_M0J105
4700	76x143	0.09	17	10	26.00	K21450472_M0J143
4700	90x98	0.09	19	13	22.10	K21450472_M0L098
5600	76x143	0.09	15	10	28.30	K21450562_M0J143
6800	76x214	0.09	11	8	37.20	K21450682_M0J214
6800	90x145	0.09	13	10	31.90	K21450682_M0L145
8200	90x145	0.09	11	8	34.90	K21450822_M0L145
10000	90x220	0.10	9	6	46.50	K21450103_M0L220
12000	90x220	0.10	8	6	49.80	K21450123_M0L220

**RATED  
VOLTAGE  
VDC**

**450V**

PLEASE TO CONTACT OUR TECHNICAL SERVICE FOR MORE INFORMATION OR SPEC-IN ANALYSIS.

# K22 TYPE -40°C +105°C 5000H

RoHS Compliant

- Surge-proof capacitor in aluminium can with insulation sleeve.
- To be mounted with ring clips or with threaded stud
- Design optimized for high ripple current applications

## APPLICATIONS

Designed for professional application. Switch mode power suppliers, high ripple current converters, motor drives.

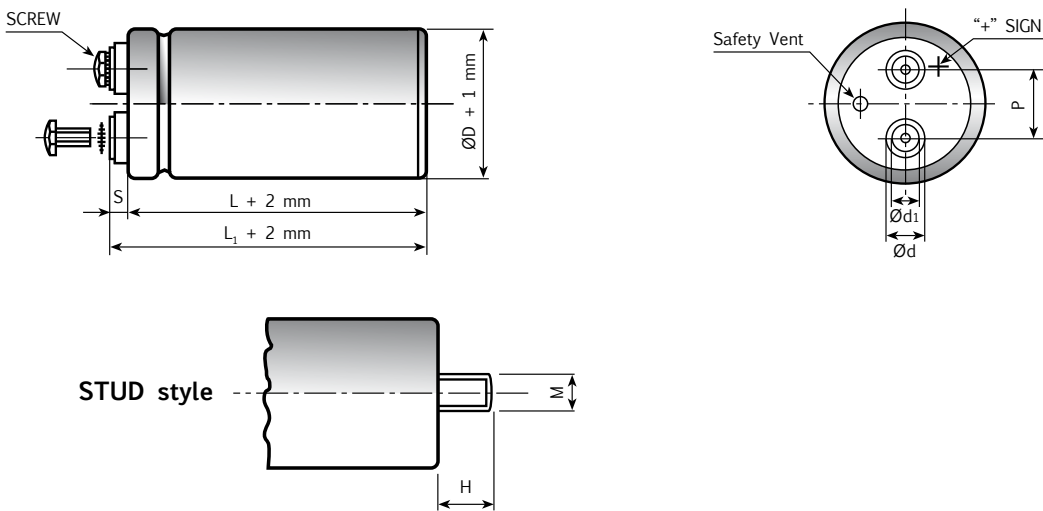

Diagram of dimensions (unit=mm)  
 Insert and screw threads: Metric (mm), UNF (inches)

ØD	d	d1	P	STUD		INSERT	SCREW	L <sub>1</sub>	-L[-1+3]	S[-1+1]	INSERT STYLE CODE
				M	H						
35	11	7.9	12.7	M8	12	M5	5MA x 9.5	2.5		5	O
51	18.5	13	22.7	M12	16	M5	5MA x 9.5	2.5		5	H
63	18.5	13	28.6	M12	16	M5	5MA x 9.5	2.5		5	H
63	17.3	17.3	28.6	M12	16	UNF 1/4-28 Low Post	1/4-28 x 3/8"	3		4	W
63	17.3	17.3	28.6	M12	16	UNF 1/4-28 High Post	1/4-28 x 1/2"	6		7	R
63	7.9	7.9	28.6	M12	16	UNF 10-32 Low Post	10-32 x 1/4"	2		2.5	Z
63	12	7.9	28.6	M12	16	UNF 10-32 High Post	10-32 x 3/8"	6		7	U
76	18.5	13	31.8	M12	16	M5	5MA x 9.5	2.5		5	H
76	18.5	13	31.8	M12	16	M5	5MA x 9.5	2.5		7	L
76	23.2	17.7	31.8	M12	16	M6	6MA x 10	4.5		7	6
76	17.3	17.3	31.8	M12	16	UNF 1/4-28 Low Post	1/4-28 x 3/8"	3		4	W
76	17.3	17.3	31.8	M12	16	UNF 1/4-28 High Post	1/4-28 x 1/2"	6		7	R
76	7.9	7.9	31.8	M12	16	UNF 10-32 Low Post	10-32 x 1/4"	2		2.5	Z
76	12	7.9	31.8	M12	16	UNF 10-32 High Post	10-32 x 3/8"	6		7	U
90	23.2	17.7	31.8	M12	16	M6	6MA x 10	4.5		7	H

## SPECIFICATIONS

<b>Temperature Range</b>	Operating: -40°C +105°C Storage : Preferably below +25°C, not exceeding +40°C	[Environmental classification 40/105/56 IEC-68]																																										
<b>Rated Voltage Range (V<sub>r</sub>)</b>	from 350V to 450V DC																																											
<b>Surge Voltage (V<sub>p</sub>)</b>	V <sub>p</sub> = 1.10 V <sub>r</sub>																																											
<b>Rated Capacitance Range</b>	from 1000 µF to 12000 µF																																											
<b>Capacitance Tolerance</b>	±20% at 100 Hz, 20°C [M class IEC-62] on request: -10% +30% at 100 Hz, 20°C [Q class IEC-62]																																											
<b>Leakage Current (I<sub>L</sub>)</b> (mA, 5 min, 20°C)	max I <sub>L</sub> = 0.003 C <sub>r</sub> V <sub>r</sub> + 4 µA At 85°C max I <sub>L</sub> = 0.02 C <sub>r</sub> V <sub>r</sub> µA																																											
<b>Ripple current (I<sub>r</sub>)</b>	<p>Refer to table at 105°C and 100Hz:</p> <table border="1"> <thead> <tr> <th>FREQUENCY</th> <th>50Hz</th> <th>100 Hz</th> <th>500Hz</th> <th>1000Hz</th> <th>&gt;10kHz</th> </tr> </thead> <tbody> <tr> <td>MULTIPLIER</td> <td>0.8</td> <td>1.0</td> <td>1.2</td> <td>1.3</td> <td>1.5</td> </tr> </tbody> </table> <table border="1"> <thead> <tr> <th>AMBIENT TEMP</th> <th>35°C</th> <th>45°C</th> <th>55°C</th> <th>65°C</th> <th>75°C</th> <th>85°C</th> <th>95°C</th> <th>105°C</th> <th>110°C</th> </tr> </thead> <tbody> <tr> <td>MULTIPLIER</td> <td>3.0</td> <td>2.8</td> <td>2.6</td> <td>2.4</td> <td>2.2</td> <td>1.8</td> <td>1.5</td> <td>1.0</td> <td>0.5</td> </tr> </tbody> </table> <p>Maximum internal temperature 110°C</p> <p>Due to the current load capability of the contact elements, the following limits must not be exceeded:</p> <table border="1"> <thead> <tr> <th>CAPACITOR DIAMETER</th> <th>51mm</th> <th>63mm</th> <th>76mm</th> <th>90mm</th> </tr> </thead> <tbody> <tr> <td>Maximum current</td> <td>30A</td> <td>40A</td> <td>50A</td> <td>70A</td> </tr> </tbody> </table>		FREQUENCY	50Hz	100 Hz	500Hz	1000Hz	>10kHz	MULTIPLIER	0.8	1.0	1.2	1.3	1.5	AMBIENT TEMP	35°C	45°C	55°C	65°C	75°C	85°C	95°C	105°C	110°C	MULTIPLIER	3.0	2.8	2.6	2.4	2.2	1.8	1.5	1.0	0.5	CAPACITOR DIAMETER	51mm	63mm	76mm	90mm	Maximum current	30A	40A	50A	70A
FREQUENCY	50Hz	100 Hz	500Hz	1000Hz	>10kHz																																							
MULTIPLIER	0.8	1.0	1.2	1.3	1.5																																							
AMBIENT TEMP	35°C	45°C	55°C	65°C	75°C	85°C	95°C	105°C	110°C																																			
MULTIPLIER	3.0	2.8	2.6	2.4	2.2	1.8	1.5	1.0	0.5																																			
CAPACITOR DIAMETER	51mm	63mm	76mm	90mm																																								
Maximum current	30A	40A	50A	70A																																								
<b>Insulation Resistance</b>	At 100V DC for 1 min is >100 MΩ across insulating sleeve and terminals.																																											
<b>Vibration Resistance</b>	Frequency range: 10 Hz to 55 Hz, amplitude 0.75 mm Capacitor length ≤ 143 : max acceleration 10g for 3x2 h Capacitor length > 143 : max acceleration 5g for 3x0.5 h																																											
<b>Life test</b>	After 2,000 hours application of rated voltage at 105°C capacitors meet characteristics aside	Cap change ≤ 10% tan δ ≤ 130% Leakage current (I <sub>L</sub> ) < initial limit Impedance (Z) ≤ 130%																																										
<b>Shelf life</b>	After leaving capacitors under no load for 500 hours at 105°C when restored at 20°C meet specifications aside	Cap change ≤ ±15% tan δ ≤ 150% Leakage current (I <sub>L</sub> ) < initial limit																																										
<b>Useful life</b> (V <sub>n</sub> , Temp rated I ripple applied)	> 250000 h at 40°C > 5000 h at 105°C																																											
<b>Failure percentage</b> <b>Failure rate</b>	≤ 1% (during useful life) ≤ 40 fit (40 10 <sup>-9</sup> /h)																																											
<b>Self inductance</b>	Approx. 20 nH																																											
<b>Reference standards</b>	CECC 30.300 IEC 60384-4 LONG LIFE GRADE																																											

## K22 TYPE STANDARD RATINGS

**RATED  
VOLTAGE  
VDC**

**350V**

Cap µF	Ø x L mm	Tan δ MAX 100 Hz 20°C	ESR TYP mΩ 100 Hz 20°C	Z TYP mΩ 10 kHz 20°C	I <sub>r</sub> a.c. A max 100 Hz 105°C	PART NUMBER stud and insert style excluded
1200	51x79	0.08	44	26	5.44	K22350122_M0G079
1200	51x105	0.08	44	26	6.08	K22350122_M0G105
1500	51x105	0.08	40	24	6.78	K22350152_M0G105
1800	51x105	0.08	40	24	6.78	K22350182_M0G105
2200	63x105	0.08	24	15	9.93	K22350222_M0H105
2200	76x79	0.08	24	15	9.15	K22350222_M0J079
2200	76x98	0.08	24	15	9.86	K22350222_M0J098
2800	63x105	0.08	22	14	10.90	K22350282_M0H105
3300	76x79	0.08	20	13	10.20	K22350332_M0J079
3300	76x105	0.08	20	13	12.00	K22350332_M0J105
3900	76x105	0.08	16	11	13.40	K22350392_M0J105
3900	90x98	0.08	16	11	13.50	K22350392_M0L098
4700	76x143	0.09	13	10	16.70	K22350472_M0J143
5600	76x143	0.09	10	8	18.20	K22350562_M0J143
6800	76x214	0.09	9	6	23.00	K22350682_M0J214
6800	90x145	0.09	9	6	20.40	K22350682_M0L145
8200	76x214	0.09	8	6	23.30	K22350682_M0J214
8200	90x145	0.09	8.5	6	22.30	K22350822_M0L145
10000	76x214	0.09	7	5	24.70	K22350103_M0J214
10000	90x145	0.09	7	5	22.70	K22350103_M0L145
12000	90x220	0.10	6.5	4	31.80	K22350123_M0L220

**RATED  
VOLTAGE  
VDC**

**400V**

Cap µF	Ø x L mm	Tan δ MAX 100 Hz 20°C	ESR TYP mΩ 100 Hz 20°C	Z TYP mΩ 10 kHz 20°C	I <sub>r</sub> a.c. A max 100 Hz 105°C	PART NUMBER stud and insert style excluded
1200	51x79	0.08	44	26	5.44	K22400122_M0G079
1200	51x105	0.08	44	26	6.08	K22400122_M0G105
1500	51x105	0.08	40	24	6.78	K22400152_M0G105
2200	63x105	0.08	24	15	9.93	K22400222_M0H105
2200	76x79	0.08	24	15	9.15	K22400222_M0J079
2200	76x98	0.08	24	15	9.86	K22400222_M0J098
3300	76x105	0.08	20	13	12.00	K22400332_M0J105
3900	76x105	0.08	16	11	13.40	K22400392_M0J105
4400	90x98	0.08	15	10	14.00	K22400442_M0L098
4700	76x143	0.09	13	10	16.70	K22400472_M0J143
5600	76x143	0.09	10	8	18.20	K22400562_M0J143
6800	76x214	0.09	9	6	23.00	K22400682_M0J214
6800	90x145	0.09	9	6	20.40	K22400682_M0L145
8200	90x145	0.09	8.5	6	22.30	K22400822_M0L145
10000	90x220	0.09	7	5	29.70	K22400103_M0L220
12000	90x220	0.10	6.5	4	31.80	K22400123_M0L220

## K22 TYPE STANDARD RATINGS

Cap µF	Ø x L mm	Tan δ MAX 100 Hz 20°C	ESR TYP mΩ 100 Hz 20°C	Z TYP mΩ 10 kHz 20°C	Ir a.c. A max 100 Hz 105°C	PART NUMBER stud and insert style excluded
1200	51x79	0.08	44	26	5.44	K22420122_M0G079
1200	51x105	0.08	44	26	6.08	K22420122_M0G105
1500	51x105	0.08	40	24	6.78	K22420152_M0G105
2200	63x105	0.08	24	15	9.93	K22420222_M0H105
2200	76x79	0.08	24	15	9.15	K22420222_M0J079
2200	76x98	0.08	24	15	9.86	K22420222_M0J098
3300	76x105	0.08	20	13	12.00	K22420332_M0J105
3900	76x105	0.08	16	11	13.40	K22420392_M0J105
4400	90x98	0.08	15	10	14.00	K22420442_M0L098
4700	76x143	0.09	13	10	16.70	K22420472_M0J143
5600	76x143	0.09	10	8	18.20	K22420562_M0J143
6800	76x214	0.09	9	6	23.00	K22420682_M0J214
6800	90x145	0.09	9	6	20.40	K22420682_M0L145
8200	90x145	0.09	8.5	6	22.30	K22420822_M0L145
10000	90x220	0.09	7	5	29.70	K22420103_M0L220
12000	90x220	0.10	6.5	4	31.80	K22420123_M0L220

**RATED  
VOLTAGE  
VDC**

**420V**

Cap µF	Ø x L mm	Tan δ MAX 100 Hz 20°C	ESR TYP mΩ 100 Hz 20°C	Z TYP mΩ 10 kHz 20°C	Ir a.c. A max 100 Hz 105°C	PART NUMBER stud and insert style excluded
1000	51x79	0.08	67	40	5.20	K22450102_M0G079
1000	51x105	0.08	67	40	5.61	K22450102_M0G105
1200	51x105	0.08	56	32	6.23	K22450122_M0G105
2200	63x105	0.08	30	18	9.75	K22450222_M0H105
2200	76x79	0.08	36	20	8.90	K22450222_M0J079
2200	76x98	0.08	36	20	8.90	K22450222_M0J098
2800	90x98	0.08	28	16	12.20	K22450282_M0L098
3300	76x105	0.08	26	16	11.60	K22450332_M0J105
3900	76x143	0.08	19	14	15.30	K22450392_M0J143
4700	76x143	0.09	16	9	16.70	K22450472_M0J143
5600	90x145	0.09	15	9	18.80	K22450562_M0L145
6800	76x214	0.09	11	6	23.70	K22450682_M0J214
6800	90x145	0.09	11	7	20.60	K22450682_M0L145
8200	90x220	0.09	10	6	27.40	K22450822_M0L220
10000	90x220	0.10	9	6	29.60	K22450103_M0L220

**RATED  
VOLTAGE  
VDC**

**450V**

PLEASE TO CONTACT OUR TECHNICAL SERVICE FOR MORE INFORMATION OR SPEC-IN ANALYSIS.

# K41 TYPE -40°C +85°C 15000H

RoHS Compliant

- Surge-proof capacitor in aluminium can with insulation sleeve.
- To be mounted with ring clips or with threaded stud.
- Design optimized for long term vibration stress, traction market.
- Octagonal can shape.

## APPLICATIONS

Designed for professional application under high mechanical stress.

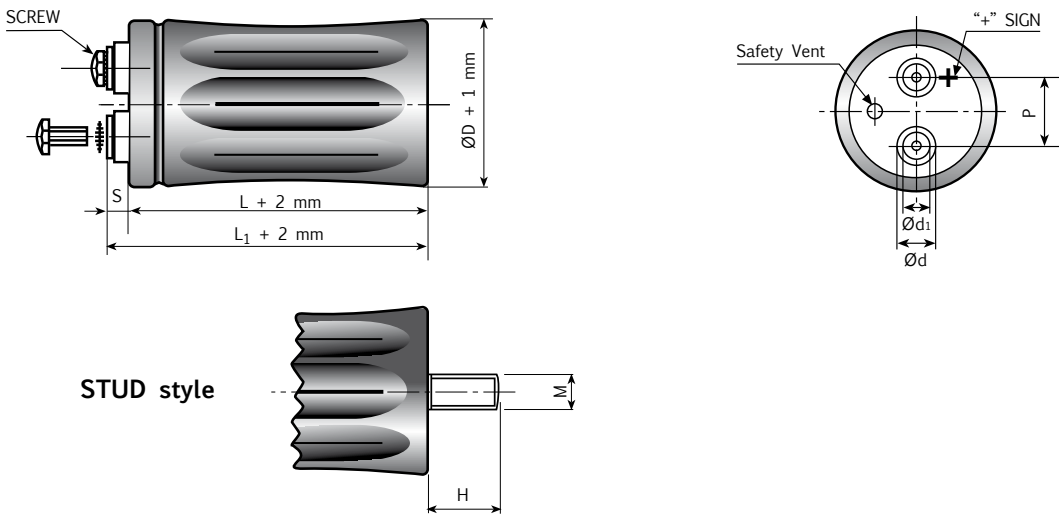

Diagram of dimensions (unit=mm)  
Insert and screw threads: Metric (mm), UNF (inches)

ØD	d	d1	P	STUD M H	INSERT	SCREW	L1 -L[-1+3]	S[-1+1]	INSERT STYLE CODE
35	11	7.9	12.7	M8 12	M5	5MA x 9.5	2.5	5	O
51	18.5	13	22.7	M12 16	M5	5MA x 9.5	2.5	5	H
63	18.5	13	28.6	M12 16	M5	5MA x 9.5	2.5	5	H
63	17.3	17.3	28.6	M12 16	UNF 1/4-28 Low Post	1/4-28 x 3/8"	3	4	W
63	17.3	17.3	28.6	M12 16	UNF 1/4-28 High Post	1/4-28 x 1/2"	6	7	R
63	7.9	7.9	28.6	M12 16	UNF 10-32 Low Post	10-32 x 1/4"	2	2.5	Z
63	12	7.9	28.6	M12 16	UNF 10-32 High Post	10-32 x 3/8"	6	7	U
76	18.5	13	31.8	M12 16	M5	5MA x 9.5	2.5	5	H
76	18.5	13	31.8	M12 16	M5	5MA x 9.5	2.5	7	L
76	23.2	17.7	31.8	M12 16	M6	6MA x 10	4.5	7	6
76	17.3	17.3	31.8	M12 16	UNF 1/4-28 Low Post	1/4-28 x 3/8"	3	4	W
76	17.3	17.3	31.8	M12 16	UNF 1/4-28 High Post	1/4-28 x 1/2"	6	7	R
76	7.9	7.9	31.8	M12 16	UNF 10-32 Low Post	10-32 x 1/4"	2	2.5	Z
76	12	7.9	31.8	M12 16	UNF 10-32 High Post	10-32 x 3/8"	6	7	U
90	23.2	17.7	31.8	M12 16	M6	6MA x 10	4.5	7	H



## SPECIFICATIONS

<b>Temperature Range</b>	Operating: -40°C +85°C Storage : Preferably below +25°C, not exceeding +40°C	[Environmental classification 40/85/56 IEC-68]																																								
<b>Rated Voltage Range (V<sub>r</sub>)</b>	from 16V to 500V DC																																									
<b>Surge Voltage (V<sub>p</sub>)</b>	V <sub>p</sub> = 1.05 V <sub>r</sub> (V <sub>r</sub> > 450V DC) V <sub>p</sub> = 1.15 V <sub>r</sub> (V <sub>r</sub> ≤ 250V DC) V <sub>p</sub> = 1.10 V <sub>r</sub> (V <sub>r</sub> > 250V DC)																																									
<b>Rated Capacitance Range</b>	from 220 µF to 1500000 µF																																									
<b>Capacitance Tolerance</b>	±20% at 100 Hz, 20°C [M class IEC-62] on request: -10% +30% at 100 Hz, 20°C [Q class IEC-62]																																									
<b>Leakage Current (I<sub>L</sub>) (mA, 5 min, 20°C)</b>	max I <sub>L</sub> = 0.006 C <sub>r</sub> V <sub>r</sub> + 4 µA At 85°C max I <sub>L</sub> = 0.04 C <sub>r</sub> V <sub>r</sub> µA	Kendeil product limit: I <sub>L</sub> = 0.003 C <sub>r</sub> V <sub>r</sub>																																								
<b>Ripple current (I<sub>r</sub>)</b>	Refer to table at 85°C and 100Hz. For different temperature and frequency multiplier must be used as follows:																																									
	<table style="width: 100%; border-collapse: collapse;"> <tr> <td style="text-align: left;">FREQUENCY</td> <td>50Hz</td> <td>100Hz</td> <td>500 Hz</td> <td>1000Hz</td> <td>&gt;10kHz</td> <td></td> <td></td> </tr> <tr> <td style="text-align: left;">MULTIPLIER</td> <td>0.8</td> <td>1.0</td> <td>1.2</td> <td>1.3</td> <td>1.5</td> <td></td> <td></td> </tr> <tr> <td style="text-align: left;">AMBIENT TEMP</td> <td>35°C</td> <td>45°C</td> <td>55°C</td> <td>65°C</td> <td>75°C</td> <td>85°C</td> <td>95°C</td> </tr> <tr> <td style="text-align: left;">MULTIPLIER</td> <td>2.2</td> <td>2.1</td> <td>1.8</td> <td>1.6</td> <td>1.4</td> <td>1.0</td> <td>0.5</td> </tr> <tr> <td style="text-align: left;">Maximum internal temperature</td> <td colspan="7">98°C</td> </tr> </table>		FREQUENCY	50Hz	100Hz	500 Hz	1000Hz	>10kHz			MULTIPLIER	0.8	1.0	1.2	1.3	1.5			AMBIENT TEMP	35°C	45°C	55°C	65°C	75°C	85°C	95°C	MULTIPLIER	2.2	2.1	1.8	1.6	1.4	1.0	0.5	Maximum internal temperature	98°C						
FREQUENCY	50Hz	100Hz	500 Hz	1000Hz	>10kHz																																					
MULTIPLIER	0.8	1.0	1.2	1.3	1.5																																					
AMBIENT TEMP	35°C	45°C	55°C	65°C	75°C	85°C	95°C																																			
MULTIPLIER	2.2	2.1	1.8	1.6	1.4	1.0	0.5																																			
Maximum internal temperature	98°C																																									
	Due to the current load capability of the contact elements, the following limits must not be exceeded:																																									
	<table style="width: 100%; border-collapse: collapse;"> <tr> <td style="text-align: left;">CAPACITOR DIAMETER</td> <td>35mm</td> <td>51mm</td> <td>63mm</td> <td>76mm</td> <td>90mm</td> </tr> <tr> <td style="text-align: left;">Maximum current</td> <td>20A</td> <td>30A</td> <td>40A</td> <td>50A</td> <td>70A</td> </tr> </table>		CAPACITOR DIAMETER	35mm	51mm	63mm	76mm	90mm	Maximum current	20A	30A	40A	50A	70A																												
CAPACITOR DIAMETER	35mm	51mm	63mm	76mm	90mm																																					
Maximum current	20A	30A	40A	50A	70A																																					
<b>Insulation Resistance</b>	At 100V DC for 1 min is >100 MΩ across insulating sleeve and terminals.																																									
<b>Vibration Resistance</b>	Frequency range: 10 Hz to 55 Hz, amplitude 0.75 mm Capacitor length ≤ 143 : max acceleration 10g for 3x2 h Capacitor length > 143 : max acceleration 5g for 3x0.5 h Centrifugal acceleration 20g for 48 hours																																									
<b>Life test</b>	After 2,000 hours application of rated voltage at 85°C capacitors meet characteristics aside	Cap change ≤ 10% tan δ ≤ 130% Leakage current (I <sub>L</sub> ) < initial limit Impedance (Z) ≤ 130%																																								
<b>Shelf life</b>	After leaving capacitors under no load for 500 hours at 85°C, when restored at 20°C meet specifications aside	Cap change ≤ ±15% tan δ ≤ 150% Leakage current (I <sub>L</sub> ) < initial limit																																								
<b>Useful life (V<sub>n</sub>, Temp rated I ripple applied)</b>	> 200000 h at 40°C > 12000 h at 85°C for V <sub>r</sub> ≤ 100V and for V <sub>r</sub> ≥ 500V > 15000 h at 85°C for 100V < V <sub>r</sub> < 500V																																									
<b>Failure percentage Failure rate</b>	≤ 1% (during useful life) ≤ 25 fit (25 10 <sup>-9</sup> /h) (V <sub>r</sub> ≤ 160V DC) ≤ 33 fit (33 10 <sup>-9</sup> /h) (V <sub>r</sub> > 160V DC)																																									
<b>Self inductance</b>	Approx. 20 nH																																									
<b>Reference standards</b>	CECC 30.300 IEC 60384-4 LONG LIFE GRADE																																									

## K41 TYPE STANDARD RATINGS

Cap $\mu\text{F}$	$\varnothing \times L$ mm	Tan $\delta$ MAX 100 Hz 20°C	ESR TYP m $\Omega$ 100 Hz 20°C	Z TYP m $\Omega$ 10 kHz 20°C	I <sub>r</sub> a.c. A max 100 Hz 85°C	PART NUMBER stud and insert style excluded
22000	35x60	0.35	18	16	6.6	K41016223__M0E060
33000	35x79	0.40	15	13	10.2	K41016333__M0E079
47000	51x79	0.55	13	12	12.5	K41016473__M0G079
68000	51x79	0.60	12	11	15.7	K41016683__M0G079
100000	51x79	0.80	10	11	16.5	K41016104__M0G079
100000	51x105	0.80	10	10	18.7	K41016104__M0G079
150000	51x105	1.10	10	9	19.5	K41016154__M0G105
150000	63x105	1.10	10	9	21.5	K41016154__M0H105
220000	63x105	1.50	8	8	22.4	K41016224__M0H105
330000	63x105	1.90	8	8	23.3	K41016334__M0H105
330000	76x105	1.90	8	8	25.0	K41016334__M0J105
470000	76x105	1.90	5	5	28.5	K41016474__M0J105
470000	76x143	1.90	5	5	32.0	K41016474__M0J143
680000	76x143	2.50	4	4	32.5	K41016684__M0J143
1000000	76x214	2.50	3	3	44.5	K41016105__M0J214
1500000	90x220	3.00	3	3	48.7	K41016155__M0L220

**RATED  
VOLTAGE  
VDC**

**16V**

Cap $\mu\text{F}$	$\varnothing \times L$ mm	Tan $\delta$ MAX 100 Hz 20°C	ESR TYP m $\Omega$ 100 Hz 20°C	Z TYP m $\Omega$ 10 kHz 20°C	I <sub>r</sub> a.c. A max 100 Hz 85°C	PART NUMBER stud and insert style excluded
10000	35x60	0.25	27	21	5.9	K41025103__M0E060
15000	35x60	0.28	16	12	9.3	K41025153__M0E060
22000	35x79	0.35	18	16	11.8	K41025223__M0E079
33000	35x79	0.40	15	14	12.1	K41025333__M0E079
33000	51x79	0.40	15	14	13.3	K41025333__M0G079
47000	51x79	0.50	12	10	15.7	K41025473__M0G079
68000	51x79	0.60	10	9	16.4	K41025683__M0G079
68000	51x105	0.60	10	9	18.7	K41025683__M0G105
100000	51x105	0.70	10	9	19.5	K41025104__M0G105
100000	63x105	0.70	10	9	21.5	K41025104__M0H105
150000	63x105	1.00	9	9	22.0	K41025154__M0H105
150000	76x105	1.00	9	9	23.5	K41025154__M0J105
220000	76x105	1.50	9	9	24.2	K41025224__M0J105
220000	76x143	1.50	9	9	28.5	K41025224__M0J105
330000	76x143	2.00	9	9	30.5	K41025334__M0J143
470000	76x214	2.00	5	5	35.6	K41025474__M0J214

**RATED  
VOLTAGE  
VDC**

**25V**

## K41 TYPE STANDARD RATINGS

Cap µF	Ø x L mm	Tan δ MAX 100 Hz 20°C	ESR TYP m Ω 100 Hz 20°C	Z TYP m Ω 10 kHz 20°C	I <sub>r</sub> a.c. A max 100 Hz 85°C	PART NUMBER stud and insert style excluded
10000	35x60	0.20	18	12	6.5	K41040103__M0E060
15000	35x60	0.25	13	10	7.4	K41040153__M0E060
15000	35x79	0.25	13	10	8.6	K41040153__M0E079
22000	35x79	0.30	16	14	8.9	K41040223__M0E079
22000	51x79	0.30	16	14	10.4	K41040223__M0G079
33000	51x79	0.35	15	13	13.5	K41040333__M0G079
47000	51x79	0.40	10	9	14.2	K41040473__M0G079
47000	51x105	0.40	10	9	15.1	K41040473__M0G105
47000	63x105	0.40	10	9	17.6	K41040473__M0H105
68000	51x105	0.50	10	8	18.2	K41040683__M0G105
68000	63x105	0.50	10	8	19.5	K41040683__M0H105
100000	63x105	0.60	9	8	21.2	K41040104__M0H105
150000	76x105	0.90	9	8	25.7	K41040154__M0J105
220000	76x143	1.00	6	6	31.5	K41040224__M0J143
330000	76x214	1.20	5	5	38.5	K41040334__M0J214

**RATED  
VOLTAGE  
VDC**

**40V**

Cap µF	Ø x L mm	Tan δ MAX 100 Hz 20°C	ESR TYP m Ω 100 Hz 20°C	Z TYP m Ω 10 kHz 20°C	I <sub>r</sub> a.c. A max 100 Hz 85°C	PART NUMBER stud and insert style excluded
4700	35x60	0.20	33	30	5.6	K41050472__M0E060
6800	35x60	0.20	25	24	7.0	K41050682__M0E060
10000	35x60	0.20	21	20	10.0	K41050103__M0E060
15000	35x79	0.25	17	15	11.3	K41050153__M0E079
22000	51x79	0.30	16	13	13.1	K41050223__M0G079
33000	51x105	0.35	15	13	16.0	K41050333__M0G105
33000	63x105	0.35	15	13	17.5	K41050333__M0H105
47000	51x105	0.40	12	10	16.2	K41050473__M0G105
47000	63x105	0.40	12	10	18.3	K41050473__M0H105
68000	63x105	0.60	12	9	18.0	K41050683__M0H105
68000	76x105	0.60	12	9	22.1	K41050683__M0J105
100000	76x105	0.90	8	8	23.8	K41050104__M0J105
100000	76x143	0.90	8	8	25.8	K41050104__M0J143
150000	76x143	1.00	6	6	31.5	K01050154__M0J143

**RATED  
VOLTAGE  
VDC**

**50V**

## K41 TYPE STANDARD RATINGS

Cap µF	Ø x L mm	Tan δ MAX 100 Hz 20°C	ESR TYP m Ω 100 Hz 20°C	Z TYP m Ω 10 kHz 20°C	Ir a.c. A max 100 Hz 85°C	PART NUMBER stud and insert style excluded
4700	35x60	0.15	29	25	6.2	K41063472__M0E060
6800	35x60	0.18	21	20	7.0	K41063682__M0E060
6800	35x79	0.18	21	20	8.2	K41063682__M0E079
10000	35x79	0.20	21	20	8.7	K41063103__M0E079
10000	51x79	0.20	18	16	10.1	K41063103__M0G079
15000	51x79	0.25	15	13	11.1	K41063153__M0G079
22000	51x79	0.30	13	11	12.4	K41063223__M0G079
22000	51x105	0.30	13	11	14.6	K41063223__M0G105
33000	51x105	0.35	11	10	15.6	K41063333__M0G105
33000	63x105	0.35	11	10	17.9	K41063333__M0H105
47000	63x105	0.45	11	10	18.8	K41063473__M0H105
68000	76x105	0.50	11	10	25.7	K41063683__M0J105
100000	76x105	0.55	8	8	31.5	K41063104__M0J105
100000	76x143	0.55	8	8	34.5	K41063104__M0J143
150000	76x143	0.60	6	6	36.1	K41063154__M0J143

**RATED  
VOLTAGE  
VDC**

**63V**

Cap µF	Ø x L mm	Tan δ MAX 100 Hz 20°C	ESR TYP m Ω 100 Hz 20°C	Z TYP m Ω 10 kHz 20°C	Ir a.c. A max 100 Hz 85°C	PART NUMBER stud and insert style excluded
4700	35x60	0.15	29	25	5.4	K41075472__M0E060
6800	35x79	0.18	20	20	8.5	K41075682__M0E079
10000	51x79	0.20	18	16	11.0	K41075103__M0G079
15000	51x105	0.25	15	13	12.7	K41075153__M0G105
22000	51x105	0.30	12	11	15.2	K41075223__M0G105
22000	63x105	0.30	12	11	16.2	K41075223__M0H105
33000	63x105	0.35	11	10	16.8	K41075333__M0H105
33000	76x105	0.35	11	10	18.5	K41075333__M0J105
47000	76x105	0.45	10	10	20.1	K41075473__M0J105
47000	76x143	0.45	10	10	22.1	K41075473__M0J143
68000	76x143	0.60	10	10	26.0	K41075683__M0J143
100000	76x143	0.60	8	8	34.9	K41075104__M0J143

**RATED  
VOLTAGE  
VDC**

**75V**

## K41 TYPE STANDARD RATINGS

Cap µF	Ø x L mm	Tan δ MAX 100 Hz 20°C	ESR TYP m Ω 100 Hz 20°C	Z TYP m Ω 10 kHz 20°C	Ir a.c. A max 100 Hz 85°C	PART NUMBER stud and insert style excluded
1500	35x60	0.15	84	65	4.0	K41100152__M0E060
2200	35x60	0.15	57	47	5.0	K41100222__M0E060
3300	35x60	0.15	48	39	5.3	K41100332__M0E060
3300	35x79	0.15	48	39	6.8	K41100332__M0E079
4700	35x79	0.15	30	26	7.5	K41100472__M0E079
4700	51x79	0.15	30	26	10.0	K41100472__M0G079
6800	51x79	0.20	23	20	11.1	K41100682__M0G079
10000	51x79	0.20	16	14	11.9	K41100103__M0G079
10000	51x105	0.20	16	14	13.9	K41100103__M0G105
10000	63x105	0.20	16	14	14.5	K41100103__M0H105
15000	51x105	0.25	13	12	14.8	K41100153__M0G105
15000	63x105	0.25	13	12	17.5	K41100153__M0H105
22000	63x105	0.25	12	12	18.2	K41100223__M0H105
33000	76x105	0.25	10	10	23.1	K41100333__M0J105
47000	76x143	0.30	10	9	30.2	K41100473__M0J143
68000	76x143	0.30	8	8	36.5	K41100683__M0J143
68000	76x214	0.40	6	5	39.5	K41100104__M0L214

**RATED  
VOLTAGE  
VDC**

**100V**

Cap µF	Ø x L mm	Tan δ MAX 100 Hz 20°C	ESR TYP m Ω 100 Hz 20°C	Z TYP m Ω 10 kHz 20°C	Ir a.c. A max 100 Hz 85°C	PART NUMBER stud and insert style excluded
1000	35x79	0.10	98	90	4.0	K41160102__M0E079
1500	51x79	0.10	62	71	5.3	K41160152__M0G079
2200	51x79	0.10	50	43	7.0	K41160222__M0G079
3300	51x105	0.12	35	30	8.6	K41160332__M0G105
4700	51x105	0.12	25	25	10.9	K41160472__M0G105
4700	63x105	0.12	25	25	11.9	K41160472__M0H105
6800	63x105	0.12	20	22	13.0	K41160682__M0H105
10000	76x105	0.15	13	12	17.4	K41160103__M0J105
10000	76x143	0.15	13	12	19.4	K41160103__M0J143
15000	76x143	0.15	11	10	20.9	K41160153__M0J143
22000	76x143	0.20	10	10	26.4	K41160223__M0J143
33000	76x214	0.20	8	8	34.1	K41160333__M0J214

**RATED  
VOLTAGE  
VDC**

**160V**

## K41 TYPE STANDARD RATINGS

Cap $\mu\text{F}$	$\varnothing \times L$ mm	Tan $\delta$ MAX 100 Hz 20°C	ESR TYP m $\Omega$ 100 Hz 20°C	Z TYP m $\Omega$ 10 kHz 20°C	Ir a.c. A max 100 Hz 85°C	PART NUMBER stud and insert style excluded
680	35X60	0.10	124	119	3.4	K41200681__M0E060
1000	51x79	0.10	86	88	4.2	K41200102__M0G079
1500	51x79	0.10	60	63	5.8	K41200152__M0G079
2200	51x105	0.10	40	37	7.2	K41200222__M0G105
3300	51x105	0.12	32	30	9.0	K41200332__M0G105
3300	63x105	0.12	31	29	10.2	K41200332__M0H105
4700	51x105	0.12	28	26	10.4	K41200472__M0G105
4700	63x105	0.12	27	25	11.1	K41200472__M0H105
5600	63x105	0.12	21	18	12.1	K41200562__M0H105
6800	63x105	0.12	20	16	13.9	K41200682__M0H105
6800	76x105	0.12	19	15	14.3	K41200682__M0J105
8200	76x105	0.12	16	14	14.8	K41200822__M0J105
10000	76x105	0.15	13	12	15.8	K41200103__M0J105
10000	76x143	0.15	13	12	18.6	K41200103__M0J143
15000	76x143	0.18	12	12	21.4	K41200153__M0J143
22000	76x143	0.18	9	9	28.9	K41200223__M0J143
33000	76x214	0.22	8	8	36.1	K41200333__M0J214

**RATED  
VOLTAGE  
VDC**

**200V**

Cap $\mu\text{F}$	$\varnothing \times L$ mm	Tan $\delta$ MAX 100 Hz 20°C	ESR TYP m $\Omega$ 100 Hz 20°C	Z TYP m $\Omega$ 10 kHz 20°C	Ir a.c. A max 100 Hz 85°C	PART NUMBER stud and insert style excluded
470	35x60	0.10	211	200	2.8	K41250471__M0E060
680	35x79	0.10	127	121	3.5	K41250681__M0E079
1000	51x79	0.10	110	95	4.5	K41500102__M0G079
1500	51x79	0.10	64	56	5.0	K41250152__M0G079
2200	51x105	0.10	40	36	7.5	K41250222__M0G105
3300	51x105	0.12	31	26	9.8	K41250332__M0G105
3300	63x105	0.12	30	25	11.0	K41250332__M0H105
4700	63x105	0.12	24	21	11.8	K41250472__M0H105
4700	76x105	0.12	20	18	13.2	K41250472__M0J105
5600	76x105	0.12	17	16	13.8	K41250562__M0J105
6800	76x105	0.12	15	13	14.1	K41250682__M0J105
8200	76x143	0.12	14	13	16.0	K41250822__M0J143
10000	76x143	0.13	13	12	19.7	K41250103__M0J143
15000	76x143	0.13	11	11	21.9	K41250153__M0J143
22000	76x214	0.14	10	9	34.2	K41250223__M0J214

**RATED  
VOLTAGE  
VDC**

**250V**

## K41 TYPE STANDARD RATINGS

Cap µF	Ø x L mm	Tan δ MAX 100 Hz 20°C	ESR TYP m Ω 100 Hz 20°C	Z TYP m Ω 10 kHz 20°C	Ir a.c. A max 100 Hz 85°C	PART NUMBER stud and insert style excluded
470	35X79	0.10	108	95	4.0	K41350471__M0E079
680	35X79	0.10	108	95	4.0	K41350681__M0E079
1000	51x79	0.10	79	62	5.0	K41350102__M0G079
1000	51x105	0.10	79	62	5.5	K41350102__M0G105
1500	51x105	0.10	60	52	7.4	K41350152__M0G105
2200	51x105	0.10	44	40	9.0	K41350222__M0G105
2200	63x105	0.10	37	34	9.5	K41350222__M0H105
3300	63x105	0.12	26	22	10.1	K41350332__M0H105
3300	76x105	0.12	26	22	12.8	K41350332__M0J105
4700	76x105	0.12	17	16	14.5	K41350472__M0J105
4700	76x143	0.12	17	16	17.5	K41350472__M0J143
5600	76x143	0.12	17	16	18.5	K41350562__M0J143
6800	76x143	0.12	16	15	19.2	K41350682__M0J143
8200	76x143	0.12	16	15	20.7	K41350822__M0J143
10000	76x214	0.14	15	14	26.6	K41350103__M0J214
15000	76x214	0.15	14	14	31.7	K41350153__M0J214
22000	90x220	0.20	13	13	35.4	K41350223__M0L220

**RATED  
VOLTAGE  
VDC**

**350V**

Cap µF	Ø x L mm	Tan δ MAX 100 Hz 20°C	ESR TYP m Ω 100 Hz 20°C	Z TYP m Ω 10 kHz 20°C	Ir a.c. A max 100 Hz 85°C	PART NUMBER stud and insert style excluded
220	35x60	0.10	350	288	2.1	K41400221__M0E060
330	35x60	0.10	290	273	2.8	K41400331__M0E060
470	35x79	0.10	165	155	3.5	K41400471__M0E079
680	51x79	0.10	120	115	4.7	K41400681__M0G079
680	51x105	0.10	124	120	5.1	K41400681__M0G105
1000	51x79	0.10	105	95	5.8	K41400102__M0G079
1000	51x105	0.10	110	85	6.3	K41400102__M0G105
1500	51x105	0.10	65	55	7.0	K41400152__M0G105
1500	63x105	0.10	65	55	7.9	K41400152__M0H105
2200	63x105	0.10	50	47	9.0	K41400222__M0H105
2200	76x105	0.10	50	47	10.7	K41400222__M0J105
3300	63x105	0.12	35	30	11.0	K41400332__M0H105
3300	76x105	0.12	35	30	13.1	K41400332__M0J105
3300	76x143	0.12	35	30	14.2	K41400332__M0J143
4700	76x105	0.15	30	29	14.9	K41400472__M0J105
4700	76x143	0.15	30	29	18.8	K41400472__M0J143
5600	76x143	0.15	26	25	19.0	K41400562__M0J143
6800	76x143	0.15	20	18	19.5	K41400682__M0J143
10000	76x214	0.15	20	19	26.0	K41400103__M0J214
15000	90x220	0.20	15	12	33.5	K41400153__M0L220

**RATED  
VOLTAGE  
VDC**

**400V**

## K41 TYPE STANDARD RATINGS

Cap $\mu\text{F}$	$\varnothing \times L$ mm	Tan $\delta$ MAX 100 Hz 20°C	ESR TYP m $\Omega$ 100 Hz 20°C	Z TYP m $\Omega$ 10 kHz 20°C	Ir a.c. A max 100 Hz 85°C	PART NUMBER stud and insert style excluded
470	51x79	0.10	200	179	4.0	K41450471__M0G079
680	51X79	0.10	140	128	4.4	K41450681__M0G079
680	51x105	0.10	140	128	5.0	K41450681__M0G105
1000	51x79	0.10	100	88	4.8	K41450102__M0G079
1000	51x105	0.10	100	88	6.4	K41450102__M0G105
1500	51X105	0.10	67	55	7.1	K41450152__M0G105
1500	63x105	0.10	67	55	8.0	K41450152__M0H105
2200	63x105	0.10	60	55	9.0	K41450222__M0H105
2200	76x105	0.10	60	47	11.2	K41450222__M0J105
2200	76x143	0.10	60	47	12.5	K41450222__M0J143
3300	76x105	0.12	35	30	11.2	K41450332__M0J105
3300	76x143	0.12	35	30	12.9	K41450332__M0J143
4700	76x143	0.15	32	30	15.0	K41450472__M0J143
5600	76x143	0.15	26	25	19.0	K41450562__M0J143
6800	76x214	0.15	23	22	19.0	K41450682__M0J214
8200	76x214	0.15	22	20	19.0	K41450822__M0J214
10000	76x143	0.20	22	20	19.0	K41450103__M0J143
10000	76x214	0.20	20	19	23.1	K41450103__M0J214
12000	76x214	0.20	15	12	29.8	K41450123__M0J214
15000	90x220	0.20	14	12	32.6	K41450153__M0L220

**RATED  
VOLTAGE  
VDC**

**450V**

Cap $\mu\text{F}$	$\varnothing \times L$ mm	Tan $\delta$ MAX 100 Hz 20°C	ESR TYP m $\Omega$ 100 Hz 20°C	Z TYP m $\Omega$ 10 kHz 20°C	Ir a.c. A max 100 Hz 85°C	PART NUMBER stud and insert style excluded
1000	51x105	0.15	125	114	4.0	K41500102__M0G105
1500	63x105	0.15	100	91	5.2	K41500152__M0H105
2200	76x105	0.15	70	66	7.4	K41500222__M0J105
2200	76x143	0.15	70	66	8.2	K41500222__M0J143
3300	76x143	0.15	55	53	10.3	K41500332__M0J143
4700	76x214	0.20	40	37	18.5	K41500472__M0J214
5600	76x214	0.15	26	22	19.8	K41500562__M0J214
6800	76x214	0.15	24	22	20.2	K41500682__M0J214

**RATED  
VOLTAGE  
VDC**

**500V**

PLEASE TO CONTACT OUR TECHNICAL SERVICE FOR MORE INFORMATION OR SPEC-IN ANALYSIS.



# K42 TYPE -40°C +105°C 5000H

RoHS Compliant

- Surge-proof capacitor in aluminium can with insulation sleeve.
- To be mounted with ring clips or with threaded stud.
- Design optimized for long term vibration stress, traction market.
- Octagonal can shape.

## APPLICATIONS

Designed for professional application under high mechanical stress.

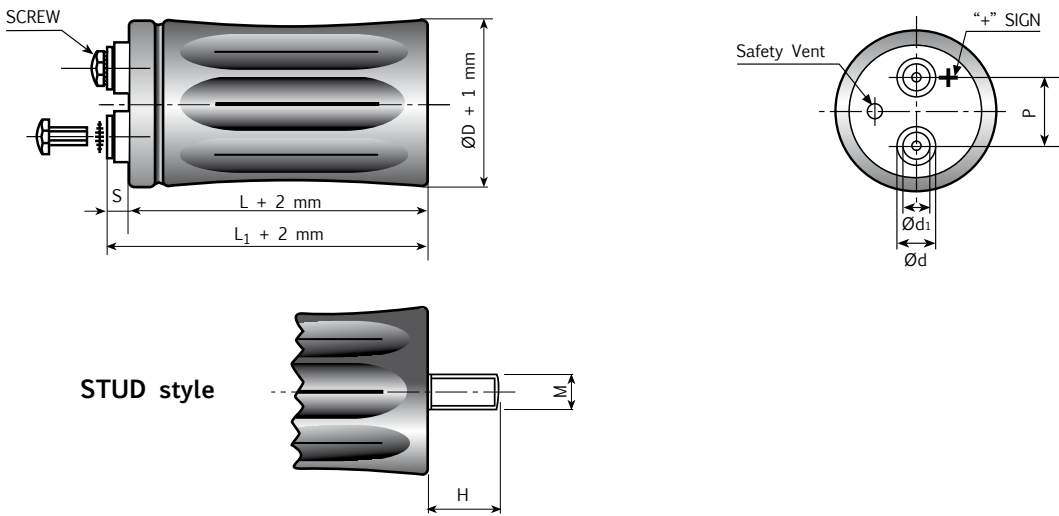

Diagram of dimensions (unit=mm)  
Insert and screw threads: Metric (mm), UNF (inches)

ØD	d	d1	P	STUD		INSERT	SCREW	L1	-L[-1+3]	S[-1+1]	INSERT STYLE CODE
				M	H						
35	11	7.9	12.7	M8	12	M5	5MA x 9.5	2.5		5	O
51	18.5	13	22.7	M12	16	M5	5MA x 9.5	2.5		5	H
63	18.5	13	28.6	M12	16	M5	5MA x 9.5	2.5		5	H
63	17.3	17.3	28.6	M12	16	UNF 1/4-28 Low Post	1/4-28 x 3/8"	3		4	W
63	17.3	17.3	28.6	M12	16	UNF 1/4-28 High Post	1/4-28 x 1/2"	6		7	R
63	7.9	7.9	28.6	M12	16	UNF 10-32 Low Post	10-32 x 1/4"	2		2.5	Z
63	12	7.9	28.6	M12	16	UNF 10-32 High Post	10-32 x 3/8"	6		7	U
76	18.5	13	31.8	M12	16	M5	5MA x 9.5	2.5		5	H
76	18.5	13	31.8	M12	16	M5	5MA x 9.5	2.5		7	L
76	23.2	17.7	31.8	M12	16	M6	6MA x 10	4.5		7	6
76	17.3	17.3	31.8	M12	16	UNF 1/4-28 Low Post	1/4-28 x 3/8"	3		4	W
76	17.3	17.3	31.8	M12	16	UNF 1/4-28 High Post	1/4-28 x 1/2"	6		7	R
76	7.9	7.9	31.8	M12	16	UNF 10-32 Low Post	10-32 x 1/4"	2		2.5	Z
76	12	7.9	31.8	M12	16	UNF 10-32 High Post	10-32 x 3/8"	6		7	U
90	23.2	17.7	31.8	M12	16	M6	6MA x 10	4.5		7	H

## SPECIFICATIONS

<b>Temperature Range</b>	Operating: -40°C +105°C Storage : Preferably below +25°C, not exceeding +40°C	[Environmental classification 40/105/56 IEC-68]
<b>Rated Voltage Range (V<sub>r</sub>)</b>	from 16V to 450V DC	
<b>Surge Voltage (V<sub>p</sub>)</b>	V <sub>p</sub> = 1.15 V <sub>r</sub> (V <sub>r</sub> ≤ 250V DC) V <sub>p</sub> = 1.10 V <sub>r</sub> (V <sub>r</sub> > 250V DC)	
<b>Rated Capacitance Range</b>	from 100 μF to 470,000 μF	
<b>Capacitance Tolerance</b>	±20% at 100 Hz, 20°C [M class IEC-62] on request: -10% +30% at 100 Hz, 20°C [Q class IEC-62]	
<b>Leakage Current (I<sub>L</sub>)</b> (mA, 5 min, 20°C)	max I <sub>L</sub> = 0.003 C <sub>r</sub> V <sub>r</sub> + 4 μA At 85°C max I <sub>L</sub> = 0.02 C <sub>r</sub> V <sub>r</sub> μA	
<b>Ripple current (I<sub>r</sub>)</b>	Refer to table at 105°C and 100Hz. For different temperature and frequency multiplier must be used as follows:	
	FREQUENCY	50Hz 100Hz 500 Hz 1000Hz >10kHz
	MULTIPLIER	0.8 1.0 1.2 1.3 1.5
	AMBIENT TEMP	35°C 45°C 55°C 65°C 75°C 85°C 95°C 105°C 110°C
	MULTIPLIER	3.0 2.80 2.60 2.40 2.20 1.80 1.5 1.0 0.5
	Maximum internal temperature 108°C	
	Due to the current load capability of the contact elements, the following limits must not be exceeded:	
	CAPACITOR DIAMETER	35mm 51mm 63mm 76mm 90mm
	Maximum current	20A 30A 40A 50A 70A
<b>Insulation Resistance</b>	At 100V DC for 1 min is >100 MΩ across insulating sleeve and terminals.	
<b>Vibration Resistance</b>	Frequency range: 10 Hz to 55 Hz, amplitude 0.75 mm Capacitor length ≤ 143 : max acceleration 10g for 3x2 h Capacitor length > 143 : max acceleration 5g for 3x0.5 h Centrifugal acceleration 20g for 48 hours	
<b>Life test</b>	After 2,000 hours application of rated voltage at 105°C capacitors meet characteristics aside	Cap change ≤ 10% tan δ ≤ 130% Leakage current (I <sub>L</sub> ) < initial limit Impedance (Z) ≤ 130%
<b>Shelf life</b>	After leaving capacitors under no load for 500 hours at 105°C when restored at 20°C meet specifications aside	Cap change ≤ ±15% tan δ ≤ 150% Leakage current (I <sub>L</sub> ) < initial limit
<b>Useful life</b> (V <sub>n</sub> , Temp rated I ripple applied)	250000 h at 40°C 5000 h at 105°C	
<b>Failure percentage</b> <b>Failure rate</b>	≤ 1% (during useful life) ≤ 40 fit (40 10 <sup>-9</sup> /h)	
<b>Self inductance</b>	Approx. 20 nH	
<b>Reference standards</b>	CECC 30.300 IEC 60384-4 LONG LIFE GRADE	

## K42 TYPE STANDARD RATINGS

Cap $\mu\text{F}$	$\varnothing \times L$ mm	Tan $\delta$ MAX 100 Hz 20°C	ESR TYP m $\Omega$ 100 Hz 20°C	Z TYP m $\Omega$ 10 kHz 20°C	Ir a.c. A max 100 Hz 105°C	PART NUMBER stud and insert style excluded
10000	35x60	0.25	25	24	3.3	K42016103__M0E060
15000	35x60	0.30	16	16	3.5	K42016153__M0E060
22000	35x60	0.35	12	12	4.4	K42016223__M0E060
33000	35x79	0.40	12	12	5.9	K42016333__M0E079
47000	35x79	0.55	9	10	7.5	K42016473__M0E079
68000	51x79	0.60	8	8	11.9	K42016683__M0G079
100000	51x105	0.80	8	8	12.3	K42016104__M0G105
150000	63x105	1.10	7	7	15.4	K42016154__M0H105
220000	76x105	1.50	7	7	18.8	K42016224__M0J105
330000	76x105	1.90	7	7	19.7	K42016334__M0J105
470000	76x143	2.00	6	6	22.5	K42016474__M0J143

**RATED  
VOLTAGE  
VDC**

**16V**

Cap $\mu\text{F}$	$\varnothing \times L$ mm	Tan $\delta$ MAX 100 Hz 20°C	ESR TYP m $\Omega$ 100 Hz 20°C	Z TYP m $\Omega$ 10 kHz 20°C	Ir a.c. A max 100 Hz 105°C	PART NUMBER stud and insert style excluded
10000	35x60	0.20	23	18	3.8	K42025103__M0E060
15000	35x60	0.25	16	12	4.8	K42025153__M0E060
22000	35x79	0.30	12	12	7.2	K42025223__M0E079
33000	51x79	0.35	10	10	8.9	K42025333__M0G079
47000	51x79	0.40	9	9	11.6	K42025473__M0G079
68000	51x105	0.50	8	8	13.0	K42025683__M0G105
100000	63x105	0.60	8	8	15.8	K42025104__M0H105
150000	76x105	0.90	7	7	18.3	K42025154__M0J105
220000	76x143	1.30	7	7	21.6	K42025224__M0J143
330000	76x143	2.00	7	7	23.8	K42025334__M0J143

**RATED  
VOLTAGE  
VDC**

**25V**

## K42 TYPE STANDARD RATINGS

Cap $\mu\text{F}$	$\varnothing \times L$ mm	Tan $\delta$ MAX 100 Hz 20°C	ESR TYP m $\Omega$ 100 Hz 20°C	Z TYP m $\Omega$ 10 kHz 20°C	I <sub>r</sub> a.c. A max 100 Hz 105°C	PART NUMBER stud and insert style excluded
4700	35x60	0.20	31	29	3.3	K42040472__M0E060
6800	35x60	0.20	23	20	3.9	K42040682__M0E060
10000	35x79	0.20	16	12	4.8	K42040103__M0E079
15000	35x79	0.20	12	10	5.4	K42040153__M0E079
22000	51x79	0.25	10	10	8.9	K42040223__M0G079
33000	51x105	0.35	10	10	11.2	K42040333__M0G105
47000	51x105	0.45	9	9	13.8	K42040473__M0G105
47000	63x105	0.45	9	9	14.5	K42040473__M0H105
68000	63x105	0.60	7	7	15.0	K42040683__M0H105
68000	76x105	0.60	7	7	15.9	K42040683__M0J105
100000	76x105	0.90	7	7	19.1	K42040104__M0J105
100000	76x143	0.90	7	7	21.0	K42040104__M0J143
150000	76x143	1.30	7	7	25.9	K42040154__M0J143

**RATED  
VOLTAGE  
VDC**

**40V**

Cap $\mu\text{F}$	$\varnothing \times L$ mm	Tan $\delta$ MAX 100 Hz 20°C	ESR TYP m $\Omega$ 100 Hz 20°C	Z TYP m $\Omega$ 10 kHz 20°C	I <sub>r</sub> a.c. A max 100 Hz 105°C	PART NUMBER stud and insert style excluded
2200	35x60	0.15	72	60	2.5	K42063222__M0E060
3300	35x60	0.15	48	39	3.5	K42063332__M0E060
4700	35x60	0.15	33	28	4.2	K42063472__M0E060
6800	35x79	0.18	18	13	6.3	K42063682__M0E079
10000	51x79	0.20	15	11	8.2	K42063103__M0G079
15000	51x79	0.25	15	13	8.9	K42063153__M0G079
15000	51x105	0.25	13	10	18.0	K42063153__M0G105
22000	51x105	0.30	11	10	11.8	K42063223__M0G105
22000	63x105	0.30	11	10	13.5	K42063223__M0H105
33000	63x105	0.35	11	10	14.8	K42063333__M0H105
33000	76x105	0.35	11	8	16.6	K42063333__M0J105
47000	76x105	0.45	9	8	17.7	K42063473__M0J105
47000	76x143	0.45	9	8	19.0	K42063473__M0J143
68000	76x105	0.45	8	8	20.1	K42063683__M0J105
68000	76x143	0.70	8	8	22.8	K42063683__M0J143
100000	76x143	0.70	8	8	24.1	K42063104__M0J143

**RATED  
VOLTAGE  
VDC**

**63V**

## K42 TYPE STANDARD RATINGS

Cap $\mu\text{F}$	$\varnothing \times L$ mm	Tan $\delta$ MAX 100 Hz 20°C	ESR TYP m $\Omega$ 100 Hz 20°C	Z TYP m $\Omega$ 10 kHz 20°C	Ir a.c. A max 100 Hz 105°C	PART NUMBER stud and insert style excluded
1000	35x60	0.15	110	100	2.9	K42100102__M0E060
1500	35x60	0.15	80	73	3.2	K42100152__M0E060
2200	35x60	0.15	59	53	4.4	K42100222__M0E060
3300	35x79	0.15	33	31	5.8	K42100332__M0E079
4700	51x79	0.15	25	22	7.2	K42100472__M0G079
6800	51x79	0.15	19	17	8.9	K42100682__M0G079
6800	51x105	0.15	19	17	8.9	K42100682__M0G105
10000	51x105	0.15	17	15	11.0	K42100103__M0G105
10000	63x105	0.15	17	15	12.5	K42100103__M0H105
15000	63x105	0.15	12	12	15.1	K42100153__M0H105
22000	76x105	0.18	10	9	16.5	K42100223__M0J105
33000	76x143	0.22	8	8	20.9	K42100333__M0J143

**RATED  
VOLTAGE  
VDC**

**100V**

Cap $\mu\text{F}$	$\varnothing \times L$ mm	Tan $\delta$ MAX 100 Hz 20°C	ESR TYP m $\Omega$ 100 Hz 20°C	Z TYP m $\Omega$ 10 kHz 20°C	Ir a.c. A max 100 Hz 105°C	PART NUMBER stud and insert style excluded
1000	35x79	0.11	105	90	3.3	K42160102__M0E079
1500	51x79	0.11	65	60	4.1	K42160152__M0G079
2200	51x105	0.11	46	43	4.8	K42160222__M0G105
3300	63x105	0.11	32	30	6.8	K42160332__M0H105
4700	63x105	0.11	27	25	8.5	K42160472__M0H105
6800	76x105	0.13	23	20	11.3	K42160682__M0J105
10000	76x105	0.14	22	20	14.2	K42160103__M0J105
10000	76x143	0.15	17	16	14.9	K42160103__M0J143
15000	76x143	0.20	16	12	17.2	K42160153__M0J143
22000	76x214	0.20	11	10	19.0	K42160223__M0J214

**RATED  
VOLTAGE  
VDC**

**160V**

## K42 TYPE STANDARD RATINGS

Cap µF	Ø x L mm	Tan δ MAX 100 Hz 20°C	ESR TYP m Ω 100 Hz 20°C	Z TYP m Ω 10 kHz 20°C	Ir a.c. A max 100 Hz 105°C	PART NUMBER stud and insert style excluded
680	35X60	0.11	133	98	2.5	K42200681__M0E060
1000	51x79	0.11	85	64	4.6	K42200102__M0G079
1500	51x105	0.11	65	58	5.1	K42200152__M0G105
2200	51x105	0.11	60	53	6.1	K42200222__M0G105
3300	63x105	0.11	40	35	7.9	K42200332__M0H105
4700	63x105	0.11	25	23	8.7	K42200472__M0H105
6800	76X105	0.11	18	16	11.8	K42200682__M0J105
8200	76x105	0.11	17	15	12.8	K42200822__M0H105
10000	76x105	0.13	15	13	14.5	K42200103__M0J105
10000	76x143	0.15	13	12	16.0	K42200103__M0J143
15000	76x143	0.20	12	11	17.3	K42200153__M0J143
22000	76x214	0.20	11	10	18.9	K42200223__M0J214

**RATED  
VOLTAGE  
VDC**

**200V**

Cap µF	Ø x L mm	Tan δ MAX 100 Hz 20°C	ESR TYP m Ω 100 Hz 20°C	Z TYP m Ω 10 kHz 20°C	Ir a.c. A max 100 Hz 105°C	PART NUMBER stud and insert style excluded
470	35x60	0.11	211	193	2.0	K42250471__M0E060
680	35x79	0.11	130	98	2.2	K42250681__M0E079
1000	51x79	0.11	110	85	4.1	K42250102__M0G079
1500	51x105	0.11	74	65	5.4	K42250152__M0G105
2200	51x105	0.11	41	39	6.8	K42250222__M0G105
3300	63x105	0.11	30	26	8.2	K42250332__M0H105
4700	76x105	0.11	18	17	11.9	K42250472__M0J105
6800	76x143	0.15	15	14	14.3	K42250682__M0J143
8200	76x143	0.15	14	14	15.2	K42250822__M0J143
10000	76x143	0.20	14	13	16.0	K42250103__M0J143
15000	76x214	0.20	12	10	17.4	K42250153__M0J214

**RATED  
VOLTAGE  
VDC**

**250V**

## K42 TYPE STANDARD RATINGS

Cap $\mu\text{F}$	$\varnothing \times L$ mm	Tan $\delta$ MAX 100 Hz 20°C	ESR TYP m $\Omega$ 100 Hz 20°C	Z TYP m $\Omega$ 10 kHz 20°C	Ir a.c. A max 100 Hz 105°C	PART NUMBER stud and insert style excluded
330	35x60	0.11	255	196	1.8	K42350331__M0E060
470	35x79	0.11	170	141	2.1	K42350471__M0E079
680	51x79	0.11	128	96	3.8	K42350681__M0G079
1000	51x105	0.11	85	68	5.0	K42350102__M0G105
1500	63x105	0.11	59	52	6.4	K42350152__M0H105
2200	76x105	0.11	44	40	8.1	K42350222__M0J105
3300	76x105	0.11	26	23	10.2	K42350332__M0J105
4700	76x143	0.11	18	16	13.5	K42350472__M0J143
5600	76x143	0.12	18	17	14.3	K42350562__M0J143
6800	76x143	0.15	16	15	15.1	K42350682__M0J143
10000	76x214	0.20	15	14	19.9	K42350103__M0J214

**RATED  
VOLTAGE  
VDC**

**350V**

Cap $\mu\text{F}$	$\varnothing \times L$ mm	Tan $\delta$ MAX 100 Hz 20°C	ESR TYP m $\Omega$ 100 Hz 20°C	Z TYP m $\Omega$ 10 kHz 20°C	Ir a.c. A max 100 Hz 105°C	PART NUMBER stud and insert style excluded
220	35x60	0.11	350	280	1.4	K42400221__M0E060
330	35x60	0.11	250	210	2.2	K42400331__M0E060
470	51x79	0.11	170	150	2.8	K42400471__M0G079
680	51x79	0.11	110	100	3.2	K42400681__M0G079
1000	51x105	0.11	95	82	4.1	K42400102__M0G105
1500	63x105	0.11	64	53	5.8	K42400152__M0H105
2200	63x105	0.11	45	53	6.0	K42400222__M0H105
2200	76x105	0.11	45	39	7.3	K42400222__M0J105
3300	76x143	0.11	28	25	11.1	K42400332__M0J143
4700	76x143	0.11	24	23	12.8	K42400472__M0J143
6800	76x214	0.15	19	15	15.0	K42400682__M0J214
10000	90x220	0.20	16	14	22.5	K42400103__M0L220

**RATED  
VOLTAGE  
VDC**

**400V**

## K42 TYPE STANDARD RATINGS

Cap μF	Ø x L mm	Tan δ MAX 100 Hz 20°C	ESR TYP m Ω 100 Hz 20°C	Z TYP m Ω 10 kHz 20°C	Ir a.c. A max 100 Hz 105°C	PART NUMBER stud and insert style excluded
100	35x60	0.11	800	650	1.2	K42450101__M0E060
150	35x60	0.11	550	490	1.6	K42450151__M0E060
220	35x60	0.11	370	310	1.8	K42450221__M0E060
330	35x79	0.11	240	210	2.4	K42450331__M0E079
470	51x79	0.11	200	179	3.0	K42450471__M0G079
680	51x105	0.11	140	128	4.2	K42450681__M0G105
1000	51x105	0.11	100	88	4.4	K42450102__M0G105
1000	63x105	0.11	100	88	5.3	K42450102__M0H105
1500	63x105	0.11	63	57	5.7	K42450152__M0H105
1500	76x105	0.11	63	57	6.6	K42450152__M0J105
2200	76x143	0.11	60	47	8.8	K42450222__M0J143
3300	76x143	0.15	35	30	10.4	K42450332__M0J143
4700	76x143	0.15	28	25	10.9	K42450472__M0J143
6800	76x214	0.15	21	16	23.7	K42450682__M0J214
10000	90x220	0.20	16	14	22.5	K42450103__M0L220

**RATED  
VOLTAGE  
VDC**

**450V**

PLEASE TO CONTACT OUR TECHNICAL SERVICE FOR MORE INFORMATION OR SPEC-IN ANALYSIS.



# K61 TYPE -40°C +85°C 25000H

RoHS Compliant

- Surge-proof capacitor in aluminium can with insulation sleeve.
- Extremely linear characteristic between 20Hz to 22KHz
- Design optimized for Audio application.
- No effects of sound compression
- Precisely and realistic dynamic of sound.

## APPLICATIONS

Designed for professional application. Linear amplifiers, audio filtering.

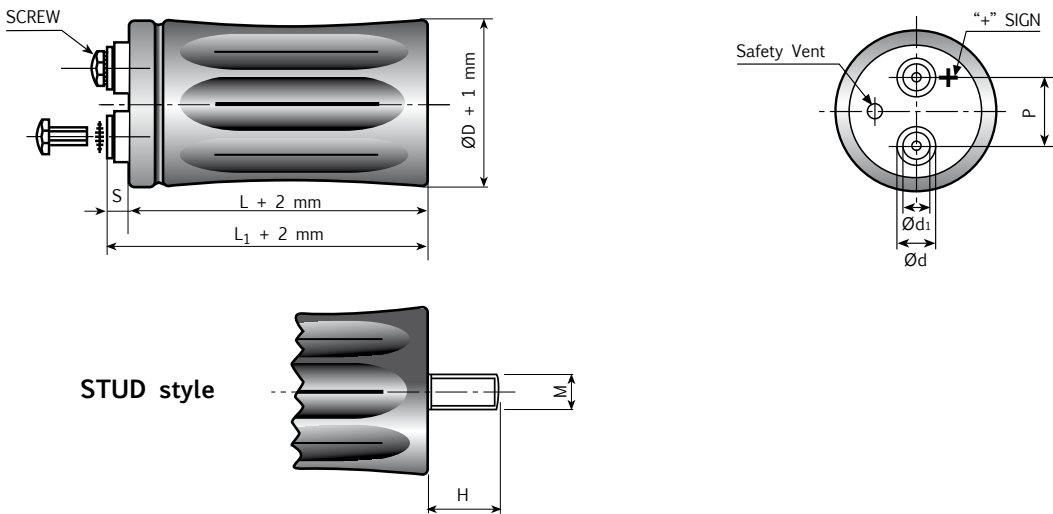

Diagram of dimensions (unit=mm)  
Insert and screw threads: Metric (mm), UNF (inches)

ØD	d	d1	P	STUD		INSERT	SCREW	L <sub>1</sub>	-L[-1+3]	S[-1+1]	INSERT STYLE CODE
				M	H						
35	11	7.9	12.7	M8	12	M5	5MA x 9.5	2.5		5	O
51	18.5	13	22.7	M12	16	M5	5MA x 9.5	2.5		5	H
63	18.5	13	28.6	M12	16	M5	5MA x 9.5	2.5		5	H
63	17.3	17.3	28.6	M12	16	UNF 1/4-28 Low Post	1/4-28 x 3/8"	3		4	W
63	17.3	17.3	28.6	M12	16	UNF 1/4-28 High Post	1/4-28 x 1/2"	6		7	R
63	7.9	7.9	28.6	M12	16	UNF 10-32 Low Post	10-32 x 1/4"	2		2.5	Z
63	12	7.9	28.6	M12	16	UNF 10-32 High Post	10-32 x 3/8"	6		7	U
76	18.5	13	31.8	M12	16	M5	5MA x 9.5	2.5		5	H
76	18.5	13	31.8	M12	16	M5	5MA x 9.5	2.5		7	L
76	23.2	17.7	31.8	M12	16	M6	6MA x 10	4.5		7	6
76	17.3	17.3	31.8	M12	16	UNF 1/4-28 Low Post	1/4-28 x 3/8"	3		4	W
76	17.3	17.3	31.8	M12	16	UNF 1/4-28 High Post	1/4-28 x 1/2"	6		7	R
76	7.9	7.9	31.8	M12	16	UNF 10-32 Low Post	10-32 x 1/4"	2		2.5	Z
76	12	7.9	31.8	M12	16	UNF 10-32 High Post	10-32 x 3/8"	6		7	U
90	23.2	17.7	31.8	M12	16	M6	6MA x 10	4.5		7	H

## SPECIFICATIONS

<b>Temperature Range</b>	Operating: -40°C +85°C Storage : Preferably below +25°C, not exceeding +40°C	[Environmental classification 40/85/56 IEC-68]																																						
<b>Rated Voltage Range (V<sub>r</sub>)</b>	from 63V to 100V DC																																							
<b>Surge Voltage (V<sub>p</sub>)</b>	V <sub>p</sub> = 1.10 V <sub>r</sub>																																							
<b>Rated Capacitance Range</b>	from 6800 µF to 47000 µF																																							
<b>Capacitance Tolerance</b>	±20% at 100 Hz, 20°C [M class IEC-62] on request: -10% +30% at 100 Hz, 20°C [Q class IEC-62]																																							
<b>Leakage Current (I<sub>L</sub>)</b> (mA, 5 min, 20°C)	max I <sub>L</sub> = 0.006 C <sub>r</sub> V <sub>r</sub> + 4 µA At 85°C max I <sub>L</sub> = 0.04 C <sub>r</sub> V <sub>r</sub> µA	Kendeil product limit: I <sub>L</sub> = 0.003 C <sub>r</sub> V <sub>r</sub>																																						
<b>Ripple current (I<sub>r</sub>)</b>	Refer to table at 85°C and 100Hz. : <table style="width: 100%; border-collapse: collapse;"> <thead> <tr> <th style="text-align: left;">FREQUENCY</th> <th>50Hz</th> <th>100Hz</th> <th>500 Hz</th> <th>1000Hz</th> <th>&gt;10kHz</th> </tr> </thead> <tbody> <tr> <td>MULTIPLIER</td> <td>0.85</td> <td>1.0</td> <td>1.2</td> <td>1.25</td> <td>1.3</td> </tr> </tbody> </table> <table style="width: 100%; border-collapse: collapse;"> <thead> <tr> <th style="text-align: left;">AMBIENT TEMP</th> <th>35°C</th> <th>45°C</th> <th>55°C</th> <th>65°C</th> <th>75°C</th> <th>85°C</th> <th>95°C</th> </tr> </thead> <tbody> <tr> <td>MULTIPLIER</td> <td>2.2</td> <td>2.1</td> <td>1.8</td> <td>1.6</td> <td>1.4</td> <td>1.0</td> <td>0.5</td> </tr> </tbody> </table> Maximum internal temperature 98°C  Due to the current load capability of the contact elements, the following limits must not be exceeded: <table style="width: 100%; border-collapse: collapse;"> <thead> <tr> <th style="text-align: left;">CAPACITOR DIAMETER</th> <th>51mm</th> <th>63mm</th> <th>76mm</th> <th>90mm</th> </tr> </thead> <tbody> <tr> <td>Maximum current</td> <td>30A</td> <td>40A</td> <td>50A</td> <td>70A</td> </tr> </tbody> </table>		FREQUENCY	50Hz	100Hz	500 Hz	1000Hz	>10kHz	MULTIPLIER	0.85	1.0	1.2	1.25	1.3	AMBIENT TEMP	35°C	45°C	55°C	65°C	75°C	85°C	95°C	MULTIPLIER	2.2	2.1	1.8	1.6	1.4	1.0	0.5	CAPACITOR DIAMETER	51mm	63mm	76mm	90mm	Maximum current	30A	40A	50A	70A
FREQUENCY	50Hz	100Hz	500 Hz	1000Hz	>10kHz																																			
MULTIPLIER	0.85	1.0	1.2	1.25	1.3																																			
AMBIENT TEMP	35°C	45°C	55°C	65°C	75°C	85°C	95°C																																	
MULTIPLIER	2.2	2.1	1.8	1.6	1.4	1.0	0.5																																	
CAPACITOR DIAMETER	51mm	63mm	76mm	90mm																																				
Maximum current	30A	40A	50A	70A																																				
<b>Insulation Resistance</b>	At 100V DC for 1 min is >100 MΩ across insulating sleeve and terminals.																																							
<b>Vibration Resistance</b>	Frequency range: 10 Hz to 55 Hz, amplitude 0.75 mm Capacitor length ≤ 143 : max acceleration 10g for 3x2 h Capacitor length > 143 : max acceleration 5g for 3x0.5 h																																							
<b>Life test</b>	After 4,000 hours application of rated voltage at 85°C capacitors meet characteristics aside	Cap change ≤ 10% tan δ ≤ 130% Leakage current (I <sub>L</sub> ) < initial limit Impedance (Z) ≤ 130%																																						
<b>Shelf life</b>	After leaving capacitors under no load for 2000 hours at 85°C, when restored at 20°C meet specifications aside	Cap change ≤ ±15% tan δ ≤ 150% Leakage current (I <sub>L</sub> ) < initial limit																																						
<b>Useful life</b> (V <sub>n</sub> , Temp rated I ripple applied)	250000 h at 40°C 25000 h at 85°C																																							
<b>Failure percentage</b> <b>Failure rate</b> I ripple applied)	≤ 1% (during useful life) ≤ 25 fit (25 10 <sup>-9</sup> /h)																																							
<b>Self inductance</b>	Approx. 20 nH																																							
<b>Reference standards</b>	CECC 30.300 IEC 60384-4 LONG LIFE GRADE																																							

## K61 TYPE STANDARD RATINGS

Cap $\mu\text{F}$	$\varnothing \times L$ mm	Tan $\delta$ MAX 100 Hz 20°C	ESR TYP m $\Omega$ 100 Hz 20°C	Z TYP m $\Omega$ 10 kHz 20°C	Ir a.c. A max 100 Hz 85°C	PART NUMBER stud and insert style excluded
10000	51x79	0.10	11	9	14.6	K61063103__M0G079
14000	51x105	0.10	9	8	18.7	K61063143__M0G105
22000	63x105	0.11	6	6	28.7	K61063223__M0H105
33000	76x105	0.12	5.5	5.5	31.2	K61063333__M0J105
47000	76x143	0.17	4	4	41.3	K61063473__M0J143

**RATED  
VOLTAGE  
VDC**

**63V**

Cap $\mu\text{F}$	$\varnothing \times L$ mm	Tan $\delta$ MAX 100 Hz 20°C	ESR TYP m $\Omega$ 100 Hz 20°C	Z TYP m $\Omega$ 10 kHz 20°C	Ir a.c. A max 100 Hz 85°C	PART NUMBER stud and insert style excluded
8200	51x79	0.10	12	8	14.4	K61080822__M0G079
10000	51x105	0.10	10	8	17.9	K61080103__M0G105
18000	63x105	0.11	6	6	28.9	K61080183__M0H105
28000	76x105	0.15	6	6	30.2	K61080283__M0J105
42000	76x143	0.17	4	4	41.3	K61080423__M0J143

**RATED  
VOLTAGE  
VDC**

**80V**

Cap $\mu\text{F}$	$\varnothing \times L$ mm	Tan $\delta$ MAX 100 Hz 20°C	ESR TYP m $\Omega$ 100 Hz 20°C	Z TYP m $\Omega$ 10 kHz 20°C	Ir a.c. A max 100 Hz 85°C	PART NUMBER stud and insert style excluded
6800	51x79	0.10	14	12	14.1	K61100682__M0G079
8200	51x105	0.10	11	8	17.9	K61100822__M0G105
10000	51x105	0.10	10	8	17.9	K61100103__M0G105
12000	63x105	0.10	7	7	28.0	K61100123__M0H105
15000	63x105	0.10	6	6	28.7	K61100153__M0H105
22000	76x105	0.11	6	6	30.2	K61100223__M0J105
33000	76x143	0.15	5	5	41.0	K61100333__M0J143

**RATED  
VOLTAGE  
VDC**

**100V**

PLEASE TO CONTACT OUR TECHNICAL SERVICE FOR MORE INFORMATION OR SPEC-IN ANALYSIS.

# K71 TYPE -40°C +85°C 15000H

RoHS Compliant

- Design optimized for extremely high miniaturization.
- Surge-proof capacitor in aluminium can with insulation sleeve.
- To be mounted with ring clips or with threaded stud.

## APPLICATIONS

Designed for professional application.  
Switch mode power suppliers, high ripple current converters, motor drives.

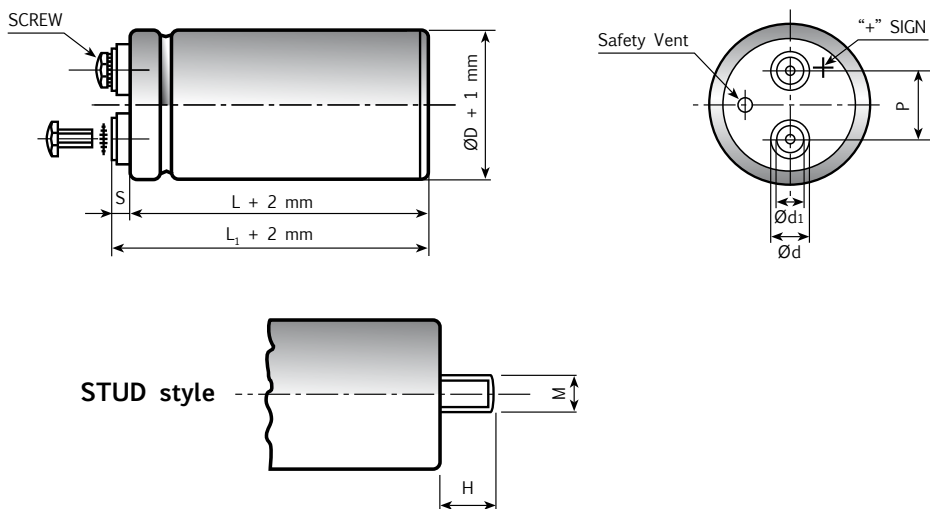

Diagram of dimensions (unit=mm)  
Insert and screw threads: Metric (mm), UNF (inches)

ØD	d	d1	P	STUD M	H	INSERT	SCREW	L <sub>1</sub> -L[-1+3]	S[-1+1]	INSERT STYLE CODE
35	11	7.9	12.7	M8	12	M5	5MA x 9.5	2.5	5	0
51	18.5	13	22.7	M12	16	M5	5MA x 9.5	2.5	5	H
63	18.5	13	28.6	M12	16	M5	5MA x 9.5	2.5	5	H
63	17.3	17.3	28.6	M12	16	UNF 1/4-28 Low Post	1/4-28 x 3/8"	3	4	W
63	17.3	17.3	28.6	M12	16	UNF 1/4-28 High Post	1/4-28 x 1/2"	6	7	R
63	7.9	7.9	28.6	M12	16	UNF 10-32 Low Post	10-32 x 1/4"	2	2.5	Z
63	12	7.9	28.6	M12	16	UNF 10-32 High Post	10-32 x 3/8"	6	7	U
76	18.5	13	31.8	M12	16	M5	5MA x 9.5	2.5	5	H
76	18.5	13	31.8	M12	16	M5	5MA x 9.5	2.5	7	L
76	23.2	17.7	31.8	M12	16	M6	6MA x 10	4.5	7	6
76	17.3	17.3	31.8	M12	16	UNF 1/4-28 Low Post	1/4-28 x 3/8"	3	4	W
76	17.3	17.3	31.8	M12	16	UNF 1/4-28 High Post	1/4-28 x 1/2"	6	7	R
76	7.9	7.9	31.8	M12	16	UNF 10-32 Low Post	10-32 x 1/4"	2	2.5	Z
76	12	7.9	31.8	M12	16	UNF 10-32 High Post	10-32 x 3/8"	6	7	U
90	23.2	17.7	31.8	M12	16	M6	6MA x 10	4.5	7	H

## SPECIFICATIONS

<b>Temperature Range</b>	Operating : -40°C +85°C [ Environmental classification 40/85/56 IEC-68 ] Storage : Preferably below +25°C, not exceeding +40°C																																							
<b>Rated Voltage Range (V<sub>r</sub>)</b>	from 350V to 450V DC																																							
<b>Surge Voltage (V<sub>p</sub>)</b>	V <sub>p</sub> = 1.10 V <sub>r</sub>																																							
<b>Rated Capacitance Range</b>	from 2200 µF to 36000 µF																																							
<b>Capacitance Tolerance</b>	±20% at 100 Hz, 20°C [M class IEC-62] on request : -10% +30% at 100 Hz, 20°C [Q class IEC-62]																																							
<b>Leakage Current (I<sub>L</sub>) (mA, 5 min, 20°C)</b>	max I <sub>L</sub> = 0.006 C <sub>r</sub> V <sub>r</sub> + 4 µA																																							
<b>Ripple current (I<sub>r</sub>)</b>	Refer to table at 85°C and 100Hz : <table style="width: 100%; border-collapse: collapse;"> <tr> <td style="text-align: left;">FREQUENCY</td> <td>50Hz</td> <td>100Hz</td> <td>500Hz</td> <td>1000Hz</td> <td>&gt;10kHz</td> </tr> <tr> <td style="text-align: left;">MULTIPLIER</td> <td>0.8</td> <td>1.0</td> <td>1.2</td> <td>1.3</td> <td>1.5</td> </tr> <tr> <td style="text-align: left;">AMBIENT TEMP</td> <td>35°C</td> <td>45°C</td> <td>55°C</td> <td>65°C</td> <td>75°C</td> <td>85°C</td> <td>95°C</td> </tr> <tr> <td style="text-align: left;">MULTIPLIER</td> <td>2.2</td> <td>2.1</td> <td>1.8</td> <td>1.6</td> <td>1.4</td> <td>1.0</td> <td>0.5</td> </tr> </table> <p>Due to the current load capability of the contact elements, the following limits must not be exceeded:</p> <table style="width: 100%; border-collapse: collapse;"> <tr> <td style="text-align: left;">CAPACITOR DIAMETER</td> <td>51mm</td> <td>63mm</td> <td>76mm</td> <td>90mm</td> </tr> <tr> <td style="text-align: left;">Maximum current</td> <td>30A</td> <td>40A</td> <td>50A</td> <td>70A</td> </tr> </table>		FREQUENCY	50Hz	100Hz	500Hz	1000Hz	>10kHz	MULTIPLIER	0.8	1.0	1.2	1.3	1.5	AMBIENT TEMP	35°C	45°C	55°C	65°C	75°C	85°C	95°C	MULTIPLIER	2.2	2.1	1.8	1.6	1.4	1.0	0.5	CAPACITOR DIAMETER	51mm	63mm	76mm	90mm	Maximum current	30A	40A	50A	70A
FREQUENCY	50Hz	100Hz	500Hz	1000Hz	>10kHz																																			
MULTIPLIER	0.8	1.0	1.2	1.3	1.5																																			
AMBIENT TEMP	35°C	45°C	55°C	65°C	75°C	85°C	95°C																																	
MULTIPLIER	2.2	2.1	1.8	1.6	1.4	1.0	0.5																																	
CAPACITOR DIAMETER	51mm	63mm	76mm	90mm																																				
Maximum current	30A	40A	50A	70A																																				
<b>Insulation Resistance</b>	At 100V DC for 1 min is >100 MΩ across insulating sleeve and terminals.																																							
<b>Vibration Resistance</b>	Frequency range : 10 Hz to 55 Hz, amplitude 0.75 mm Capacitor length ≤ 143 : max acceleration 10g for 3x2 h Capacitor length > 143 : max acceleration 5g for 3x0.5 h																																							
<b>Life test</b>	After 2,000 hours application of rated voltage at 85°C capacitors meet characteristics aside	Cap change ≤ 10% tan δ ≤ 130% Leakage current (I <sub>L</sub> ) < initial limit Impedance (Z) ≤ 130%																																						
<b>Shelf life</b>	After leaving capacitors under no load for 2000 hours at 85°C, when restored at 20°C meet specifications aside	Cap change ≤ ±15% tan δ ≤ 150% Leakage current (I <sub>L</sub> ) < initial limit																																						
<b>Useful life (85°C, V<sub>n</sub>, I<sub>r</sub> applied)</b>	> 15.000 h at 85°C																																							
<b>Operation up to 105°C with voltage derating 0,88 x V rated</b>																																								
<b>Failure percentage</b>	≤ 1% (during useful life)																																							
<b>Failure rate</b>	≤ 33 fit (33 10 <sup>-9</sup> /h)																																							
<b>Self inductance</b>	Approx. 20 nH																																							
<b>Reference standards</b>	CECC 30.300 IEC 60384-4 LONG LIFE GRADE																																							

## K71 TYPE STANDARD RATINGS

Cap $\mu\text{F}$	$\varnothing \times L$ mm	Tan $\delta$ MAX 100 Hz 20°C	ESR TYP $m\Omega$ 100 Hz 20°C	Z TYP $m\Omega$ 10 kHz 20°C	Ir a.c. A max 100 Hz 85°C	PART NUMBER stud and insert style excluded
3300	51x79	0.09	25	20	9.00	K71350332_M0G079
3500	51x79	0.09	24	17	9.05	K71350352_M0G079
4700	51x105	0.09	17	13	11.60	K71350472_M0G105
6800	63x105	0.09	15	11	17.60	K71350682_M0H105
7600	63x105	0.09	14	10	18.00	K71350762_M0H105
10000	76x105	0.10	12	11	22.20	K71350103_M0J105
11000	76x105	0.10	12	11	22.30	K71350113_M0J105
16000	90x105	0.11	10	8	26.10	K71350163_M0L105
17000	76x143	0.11	9	8	30.80	K71350173_M0J143
24000	76x214	0.11	7	5	44.00	K71350243_M0J214
24000	90x145	0.11	7	5	35.90	K71350243_M0L145
36000	90x220	0.13	5	4	51.30	K71350363_M0L220

**RATED  
VOLTAGE  
VDC**

**350V**

Cap $\mu\text{F}$	$\varnothing \times L$ mm	Tan $\delta$ MAX 100 Hz 20°C	ESR TYP $m\Omega$ 100 Hz 20°C	Z TYP $m\Omega$ 10 kHz 20°C	Ir a.c. A max 100 Hz 85°C	PART NUMBER stud and insert style excluded
2200	51x79	0.09	42	33	8.21	K71400222_M0G079
2900	51x79	0.09	38	30	8.64	K71400292_M0G079
3300	51x105	0.09	29	22	10.80	K71400332_M0G105
3900	51x105	0.09	28	19	11.10	K71400392_M0G105
4700	63x79	0.09	21	17	9.97	K71400472_M0H079
5600	63x105	0.09	19	15	16.60	K71400562_M0H105
6200	63x105	0.09	18	14	17.10	K71400622_M0H105
6800	76x105	0.09	17	13	18.60	K71400682_M0J105
8200	76x105	0.09	16	12	19.00	K71400822_M0J105
9200	76x105	0.09	14	11	21.20	K71400922_M0J105
13000	76x143	0.10	9	8	29.30	K71400133_M0J143
13000	90x105	0.10	10	9	25.20	K71400133_M0L105
20000	76x214	0.11	8	7	41.90	K71400203_M0J214
20000	90x145	0.11	8	7	34.50	K71400203_M0L145
30000	90x220	0.13	6	5	49.50	K71400303_M0L220

**RATED  
VOLTAGE  
VDC**

**400V**

## K71 TYPE STANDARD RATINGS

Cap µF	Ø x L mm	Tan δ MAX 100 Hz 20°C	ESR TYP mΩ 100 Hz 20°C	Z TYP mΩ 10 kHz 20°C	Ir a.c. A max 100 Hz 85°C	PART NUMBER stud and insert style excluded
2200	51x79	0.09	42	33	8.21	K71420222_M0G079
2500	51x79	0.09	40	22	8.42	K71420252_M0G079
3300	51x105	0.09	29	22	10.80	K71420332_M0G105
4700	63x79	0.09	21	17	9.97	K71420472_M0H079
5600	63x105	0.09	19	15	16.60	K71420562_M0H105
6800	76x105	0.09	17	13	18.60	K71420682_M0J105
8200	76x105	0.09	16	12	19.00	K71420822_M0J105
12000	76x143	0.09	9	8	28.60	K71420123_M0J143
12000	90x105	0.09	9	8	24.50	K71420123_M0L105
15000	90x145	0.09	8.5	7	32.60	K71420153_M0L145
18000	76x214	0.10	8	7	40.90	K71420183_M0J214
23000	90x220	0.13	7	6	46.80	K71420233_M0L220

**RATED  
VOLTAGE  
VDC**

**420V**

Cap µF	Ø x L mm	Tan δ MAX 100 Hz 20°C	ESR TYP mΩ 100 Hz 20°C	Z TYP mΩ 10 kHz 20°C	Ir a.c. A max 100 Hz 85°C	PART NUMBER stud and insert style excluded
2200	51x79	0.09	43	34	8.07	K71450222_M0G079
3300	51x105	0.09	32	24	10.40	K71450332_M0G105
4700	63x105	0.09	23	19	15.80	K71450472_M0H105
5600	76x105	0.09	21	18	17.60	K71450562_M0J105
6800	76x105	0.09	18	12	17.70	K71450682_M0J105
10000	90x105	0.09	14	11	22.90	K71450103_M0L105
11000	76x143	0.09	12	10	27.30	K71450113_M0J143
12000	76x214	0.09	11	9	39.10	K71450123_M0J214
15000	90x145	0.09	9	8	32.60	K71450153_M0L145
23000	90x220	0.13	7	6	46.80	K71450233_M0L220

**RATED  
VOLTAGE  
VDC**

**450V**

PLEASE TO CONTACT OUR TECHNICAL SERVICE FOR MORE INFORMATION OR SPEC-IN ANALYSIS.

## K72 TYPE -40°C +105°C 5000H

RoHS Compliant

- Design optimized for extremely high miniaturization.
- Surge-proof capacitor in aluminium can with insulation sleeve.
- To be mounted with ring clips or with threaded stud.

### APPLICATIONS

Designed for professional application.  
Switch mode power suppliers, high ripple current converters, motor drives.

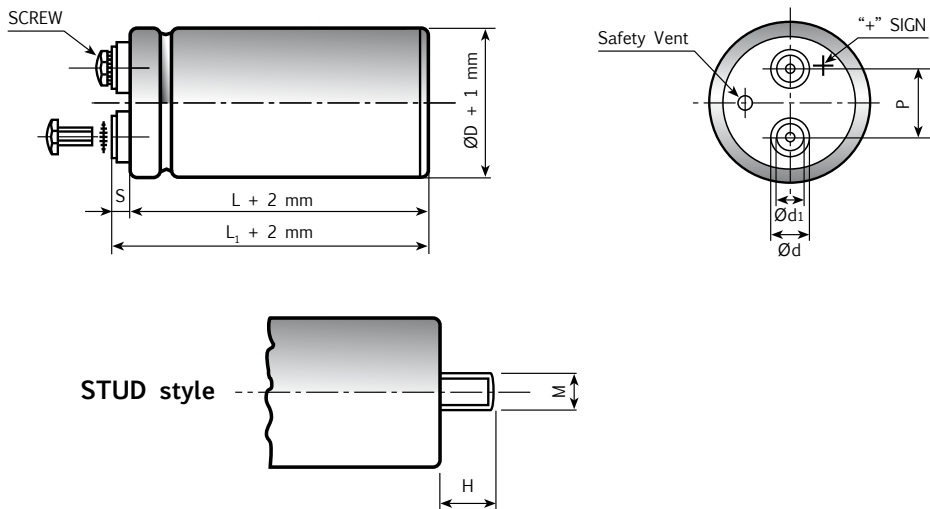

Diagram of dimensions (unit=mm)  
Insert and screw threads: Metric (mm), UNF (inches)

ØD	d	d1	P	STUD M	H	INSERT	SCREW	L <sub>1</sub> -L[-1+3]	S[-1+1]	INSERT STYLE CODE
35	11	7.9	12.7	M8	12	M5	5MA x 9.5	2.5	5	0
51	18.5	13	22.7	M12	16	M5	5MA x 9.5	2.5	5	H
63	18.5	13	28.6	M12	16	M5	5MA x 9.5	2.5	5	H
63	17.3	17.3	28.6	M12	16	UNF 1/4-28 Low Post	1/4-28 x 3/8"	3	4	W
63	17.3	17.3	28.6	M12	16	UNF 1/4-28 High Post	1/4-28 x 1/2"	6	7	R
63	7.9	7.9	28.6	M12	16	UNF 10-32 Low Post	10-32 x 1/4"	2	2.5	Z
63	12	7.9	28.6	M12	16	UNF 10-32 High Post	10-32 x 3/8"	6	7	U
76	18.5	13	31.8	M12	16	M5	5MA x 9.5	2.5	5	H
76	18.5	13	31.8	M12	16	M5	5MA x 9.5	2.5	7	L
76	23.2	17.7	31.8	M12	16	M6	6MA x 10	4.5	7	6
76	17.3	17.3	31.8	M12	16	UNF 1/4-28 Low Post	1/4-28 x 3/8"	3	4	W
76	17.3	17.3	31.8	M12	16	UNF 1/4-28 High Post	1/4-28 x 1/2"	6	7	R
76	7.9	7.9	31.8	M12	16	UNF 10-32 Low Post	10-32 x 1/4"	2	2.5	Z
76	12	7.9	31.8	M12	16	UNF 10-32 High Post	10-32 x 3/8"	6	7	U
90	23.2	17.7	31.8	M12	16	M6	6MA x 10	4.5	7	H



## SPECIFICATIONS

<b>Temperature Range</b>	Operating : -40°C +105°C [ Environmental classification 40/105/56 IEC-68 ] Storage : Preferably below +25°C, not exceeding +40°C																																											
<b>Rated Voltage Range (V<sub>r</sub>)</b>	from 350V to 450V DC																																											
<b>Surge Voltage (V<sub>p</sub>)</b>	V <sub>p</sub> = 1.10 V <sub>r</sub>																																											
<b>Rated Capacitance Range</b>	from 1500 µF to 30000 µF																																											
<b>Capacitance Tolerance</b>	±20% at 100 Hz, 20°C [M class IEC-62] on request : -10% +30% at 100 Hz, 20°C [Q class IEC-62]																																											
<b>Leakage Current (I<sub>L</sub>) (mA, 5 min, 20°C)</b>	max I <sub>L</sub> = 0.006 C <sub>r</sub> V <sub>r</sub> + 4 µA																																											
<b>Ripple current (I<sub>r</sub>)</b>	Refer to table at 105°C and 100Hz : <table style="width: 100%; border-collapse: collapse;"> <tr> <td style="text-align: left;">FREQUENCY</td> <td>50Hz</td> <td>100Hz</td> <td>500Hz</td> <td>1000Hz</td> <td>&gt;10kHz</td> </tr> <tr> <td style="text-align: left;">MULTIPLIER</td> <td>0.8</td> <td>1.0</td> <td>1.2</td> <td>1.3</td> <td>1.5</td> </tr> </table> <table style="width: 100%; border-collapse: collapse;"> <tr> <td style="text-align: left;">AMBIENT TEMP</td> <td>35°C</td> <td>45°C</td> <td>55°C</td> <td>65°C</td> <td>75°C</td> <td>85°C</td> <td>95°C</td> <td>105°C</td> <td>110°C</td> </tr> <tr> <td style="text-align: left;">MULTIPLIER</td> <td>3.0</td> <td>2.8</td> <td>2.6</td> <td>2.4</td> <td>2.2</td> <td>1.8</td> <td>1.5</td> <td>1.0</td> <td>0.5</td> </tr> </table> <p>Due to the current load capability of the contact elements, the following limits must not be exceeded:</p> <table style="width: 100%; border-collapse: collapse;"> <tr> <td style="text-align: left;">CAPACITOR DIAMETER</td> <td>51mm</td> <td>63mm</td> <td>76mm</td> <td>90mm</td> </tr> <tr> <td style="text-align: left;">Maximum current</td> <td>30A</td> <td>40A</td> <td>50A</td> <td>70A</td> </tr> </table>		FREQUENCY	50Hz	100Hz	500Hz	1000Hz	>10kHz	MULTIPLIER	0.8	1.0	1.2	1.3	1.5	AMBIENT TEMP	35°C	45°C	55°C	65°C	75°C	85°C	95°C	105°C	110°C	MULTIPLIER	3.0	2.8	2.6	2.4	2.2	1.8	1.5	1.0	0.5	CAPACITOR DIAMETER	51mm	63mm	76mm	90mm	Maximum current	30A	40A	50A	70A
FREQUENCY	50Hz	100Hz	500Hz	1000Hz	>10kHz																																							
MULTIPLIER	0.8	1.0	1.2	1.3	1.5																																							
AMBIENT TEMP	35°C	45°C	55°C	65°C	75°C	85°C	95°C	105°C	110°C																																			
MULTIPLIER	3.0	2.8	2.6	2.4	2.2	1.8	1.5	1.0	0.5																																			
CAPACITOR DIAMETER	51mm	63mm	76mm	90mm																																								
Maximum current	30A	40A	50A	70A																																								
<b>Insulation Resistance</b>	At 100V DC for 1 min is >100 MΩ across insulating sleeve and terminals.																																											
<b>Vibration Resistance</b>	Frequency range : 10 Hz to 55 Hz, amplitude 0.75 mm Capacitor length ≤ 143 : max acceleration 10g for 3x2 h Capacitor length > 143 : max acceleration 5g for 3x0.5 h																																											
<b>Life test (105°C, V<sub>n</sub>, I<sub>r</sub> applied)</b>	After 2,000 hours application of rated voltage at 105°C capacitors meet characteristics aside	Cap change ≤ 10% tan δ ≤ 130% Leakage current (I <sub>L</sub> ) < initial limit Impedance (Z) ≤ 130%																																										
<b>Shelf life</b>	After leaving capacitors under no load for 500 hours at 105°C, when restored at 20°C meet specifications aside	Cap change ≤ ±15% tan δ ≤ 150% Leakage current (I <sub>L</sub> ) < initial limit																																										
<b>Useful life (105°C, V<sub>n</sub>, I<sub>r</sub> applied)</b>	> 5.000 h at 105°C																																											
<b>Failure percentage Failure rate</b>	≤ 1% (during useful life) ≤ 40 fit (40 10 <sup>-9</sup> /h)																																											
<b>Self inductance</b>	Approx. 20 nH																																											
<b>Reference standards</b>	CECC 30.300 IEC 60384-4 LONG LIFE GRADE																																											

## K72 TYPE STANDARD RATINGS

**RATED  
VOLTAGE  
VDC**

**350V**

Cap µF	Ø x L mm	Tan δ MAX 100 Hz 20°C	ESR TYP mΩ 100 Hz 20°C	Z TYP mΩ 10 kHz 20°C	Ir a.c. A max 100 Hz 105°C	PART NUMBER stud and insert style excluded
2200	51x79	0.09	42	33	5.12	K72350222_M0G079
2900	51x79	0.09	38	29	5.36	K72350292_M0G079
3300	51x105	0.09	25	20	6.77	K72350332_M0G105
3900	51x105	0.09	23	17	6.87	K72350392_M0G105
4700	63x79	0.09	17	13	8.32	K72350472_M0H079
5600	63x105	0.09	16	12	10.40	K72350562_M0H105
6200	63x105	0.09	15	11	10.60	K72350622_M0H105
6800	76x105	0.09	15	11	12.50	K72350682_M0J105
8200	76x105	0.09	13	12	13.10	K72350822_M0J105
9200	76x105	0.09	12	11	13.30	K72350922_M0J105
10000	76x143	0.09	12	11	17.10	K72350103_M0J143
13000	76x143	0.09	9	8	18.20	K72350133_M0J143
13000	90x105	0.09	9	8	15.60	K72350133_M0L105
19000	90x145	0.11	8	7	21.40	K72350193_M0L145
20000	76x214	0.13	8	7	26.00	K72350203_M0J214
30000	90x220	0.13	6	5	30.70	K72350303_M0L220

**RATED  
VOLTAGE  
VDC**

**400V**

Cap µF	Ø x L mm	Tan δ MAX 100 Hz 20°C	ESR TYP mΩ 100 Hz 20°C	Z TYP mΩ 10 kHz 20°C	Ir a.c. A max 100 Hz 105°C	PART NUMBER stud and insert style excluded
2200	51x79	0.09	42	33	5.08	K72400222_M0G079
3100	51x105	0.09	29	22	6.54	K72400312_M0G105
3300	63x79	0.09	29	22	7.66	K72400332_M0H079
4700	63x105	0.09	21	17	9.93	K72400472_M0H105
5600	76x105	0.09	19	15	11.70	K72400562_M0J105
6800	76x105	0.09	18	14	12.50	K72400682_M0J105
8200	76x143	0.09	16	12	16.00	K72400822_M0J143
10000	76x143	0.09	14	11	17.10	K72400103_M0J143
10000	90x145	0.09	14	11	15.00	K72400103_M0L105
11000	76x143	0.09	12	10	17.20	K72400113_M0J143
16000	76x214	0.09	9	8	24.60	K72400163_M0J214
16000	90x145	0.09	9	8	20.50	K72400163_M0L145
23000	90x220	0.11	8	7	29.40	K72400233_M0L220

## K72 TYPE STANDARD RATINGS

Cap µF	Ø x L mm	Tan δ MAX 100 Hz 20°C	ESR TYP mΩ 100 Hz 20°C	Z TYP mΩ 10 kHz 20°C	Ir a.c. A max 100 Hz 105°C	PART NUMBER stud and insert style excluded
2200	51x79	0.09	42	33	5.08	K72420222_M0G079
2700	51x105	0.09	40	29	6.39	K72420272_M0G105
3300	63x79	0.09	29	22	7.66	K72420332_M0H079
4700	63x105	0.09	21	17	9.93	K72420472_M0H105
5600	76x105	0.09	16	8	11.70	K72420562_M0J105
6800	76x105	0.09	19	15	12.50	K72420682_M0J105
10000	76x143	0.09	14	11	17.10	K72420103_M0J143
10000	90x105	0.09	14	11	15.00	K72420103_M0L105
12000	90x145	0.09	11	9	18.30	K72420123_M0L145
15000	76x214	0.09	9	8	24.00	K72420153_M0J214
19000	90x220	0.09	9	8	27.20	K72420193_M0L220

**RATED  
VOLTAGE  
VDC**

**420V**

Cap µF	Ø x L mm	Tan δ MAX 100 Hz 20°C	ESR TYP mΩ 100 Hz 20°C	Z TYP mΩ 10 kHz 20°C	Ir a.c. A max 100 Hz 105°C	PART NUMBER stud and insert style excluded
1500	51x79	0.09	53	42	4.54	K72450152_M0G079
1800	51x79	0.09	50	38	4.66	K72450182_M0G079
2200	51x105	0.09	43	34	5.94	K72450222_M0G105
2400	51x105	0.09	39	31	6.00	K72450242_M0G105
2900	63x79	0.09	35	29	7.14	K72450292_M0H079
3300	63x105	0.09	32	24	8.75	K72450332_M0H105
3900	63x105	0.09	30	22	9.07	K72450392_M0H105
4700	76x105	0.09	23	19	11.10	K72450472_M0J105
5600	76x105	0.09	21	18	11.50	K72450562_M0J105
6800	76x143	0.09	19	12	15.00	K72450682_M0J143
8200	76x143	0.09	17	13	15.70	K72450822_M0J143
8200	90x105	0.09	17	13	13.90	K72450822_M0L105
10000	76x214	0.09	15	12	21.40	K72450103_M0J214
12000	76x214	0.09	11	9	22.50	K72450123_M0J214
12000	90x145	0.09	11	9	19.00	K72450123_M0L145
18000	90x220	0.09	9	8	27.40	K72450183_M0L220

**RATED  
VOLTAGE  
VDC**

**450V**

PLEASE TO CONTACT OUR TECHNICAL SERVICE FOR MORE INFORMATION OR SPEC-IN ANALYSIS.

## K91 TYPE -40°C +85°C 15000H

RoHS Compliant

- Design optimized for low equivalent series resistance and high ripple current.
- Surge-proof capacitor in aluminium can with insulation sleeve.
- To be mounted with ring clips or with threaded stud.

### APPLICATIONS

Designed for professional application.  
Switch mode power suppliers, high ripple current converters, motor drives.

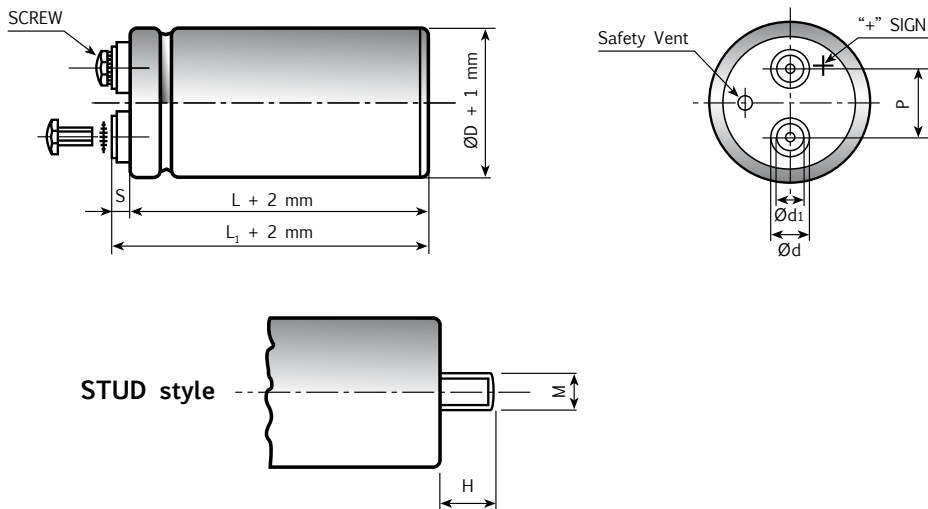

Diagram of dimensions (unit=mm)  
Insert and screw threads: Metric (mm), UNF (inches)

ØD	d	d1	P	STUD M	H	INSERT	SCREW	L <sub>1</sub> -L[-1+3]	S[-1+1]	INSERT STYLE CODE
35	11	7.9	12.7	M8	12	M5	5MA x 9.5	2.5	5	0
51	18.5	13	22.7	M12	16	M5	5MA x 9.5	2.5	5	H
63	18.5	13	28.6	M12	16	M5	5MA x 9.5	2.5	5	H
63	17.3	17.3	28.6	M12	16	UNF 1/4-28 Low Post	1/4-28 x 3/8"	3	4	W
63	17.3	17.3	28.6	M12	16	UNF 1/4-28 High Post	1/4-28 x 1/2"	6	7	R
63	7.9	7.9	28.6	M12	16	UNF 10-32 Low Post	10-32 x 1/4"	2	2.5	Z
63	12	7.9	28.6	M12	16	UNF 10-32 High Post	10-32 x 3/8"	6	7	U
76	18.5	13	31.8	M12	16	M5	5MA x 9.5	2.5	5	H
76	18.5	13	31.8	M12	16	M5	5MA x 9.5	2.5	7	L
76	23.2	17.7	31.8	M12	16	M6	6MA x 10	4.5	7	6
76	17.3	17.3	31.8	M12	16	UNF 1/4-28 Low Post	1/4-28 x 3/8"	3	4	W
76	17.3	17.3	31.8	M12	16	UNF 1/4-28 High Post	1/4-28 x 1/2"	6	7	R
76	7.9	7.9	31.8	M12	16	UNF 10-32 Low Post	10-32 x 1/4"	2	2.5	Z
76	12	7.9	31.8	M12	16	UNF 10-32 High Post	10-32 x 3/8"	6	7	U
90	23.2	17.7	31.8	M12	16	M6	6MA x 10	4.5	7	H

## SPECIFICATIONS

<b>Temperature Range</b>	Operating : -40°C +85°C [ Environmental classification 40/85/56 IEC-68 ] Storage : Preferably below +25°C, not exceeding +40°C																																							
<b>Rated Voltage Range (V<sub>r</sub>)</b>	from 400V to 450V DC																																							
<b>Surge Voltage (V<sub>p</sub>)</b>	V <sub>p</sub> = 1.10 V <sub>r</sub>																																							
<b>Rated Capacitance Range</b>	from 470 µF to 15000 µF																																							
<b>Capacitance Tolerance</b>	±20% at 100 Hz, 20°C [M class IEC-62] on request : -10% +30% at 100 Hz, 20°C [Q class IEC-62]																																							
<b>Leakage Current (I<sub>L</sub>) (mA, 5 min, 20°C)</b>	max I <sub>L</sub> = 0.006 C <sub>r</sub> V <sub>r</sub> + 4 µA																																							
<b>Ripple current (I<sub>r</sub>)</b>	Refer to table at 85°C and 100Hz : <table style="width: 100%; border-collapse: collapse;"> <tr> <td style="text-align: left;">FREQUENCY</td> <td>50Hz</td> <td>100Hz</td> <td>500Hz</td> <td>1000Hz</td> <td>&gt;10kHz</td> </tr> <tr> <td style="text-align: left;">MULTIPLIER</td> <td>0.8</td> <td>1.0</td> <td>1.2</td> <td>1.3</td> <td>1.5</td> </tr> <tr> <td style="text-align: left;">AMBIENT TEMP</td> <td>35°C</td> <td>45°C</td> <td>55°C</td> <td>65°C</td> <td>75°C</td> <td>85°C</td> <td>95°C</td> </tr> <tr> <td style="text-align: left;">MULTIPLIER</td> <td>2.2</td> <td>2.1</td> <td>1.8</td> <td>1.6</td> <td>1.4</td> <td>1.0</td> <td>0.5</td> </tr> </table> <p>Due to the current load capability of the contact elements, the following limits must not be exceeded:</p> <table style="width: 100%; border-collapse: collapse;"> <tr> <td style="text-align: left;">CAPACITOR DIAMETER</td> <td>51mm</td> <td>63mm</td> <td>76mm</td> <td>90mm</td> </tr> <tr> <td style="text-align: left;">Maximum current</td> <td>30A</td> <td>40A</td> <td>50A</td> <td>70A</td> </tr> </table>		FREQUENCY	50Hz	100Hz	500Hz	1000Hz	>10kHz	MULTIPLIER	0.8	1.0	1.2	1.3	1.5	AMBIENT TEMP	35°C	45°C	55°C	65°C	75°C	85°C	95°C	MULTIPLIER	2.2	2.1	1.8	1.6	1.4	1.0	0.5	CAPACITOR DIAMETER	51mm	63mm	76mm	90mm	Maximum current	30A	40A	50A	70A
FREQUENCY	50Hz	100Hz	500Hz	1000Hz	>10kHz																																			
MULTIPLIER	0.8	1.0	1.2	1.3	1.5																																			
AMBIENT TEMP	35°C	45°C	55°C	65°C	75°C	85°C	95°C																																	
MULTIPLIER	2.2	2.1	1.8	1.6	1.4	1.0	0.5																																	
CAPACITOR DIAMETER	51mm	63mm	76mm	90mm																																				
Maximum current	30A	40A	50A	70A																																				
<b>Insulation Resistance</b>	At 100V DC for 1 min is >100 MΩ across insulating sleeve and terminals.																																							
<b>Vibration Resistance</b>	Frequency range : 10 Hz to 55 Hz, amplitude 0.75 mm Capacitor length ≤ 143 : max acceleration 10g for 3x2 h Capacitor length > 143 : max acceleration 5g for 3x0.5 h																																							
<b>Life test</b>	After 2,000 hours application of rated voltage at 85°C capacitors meet characteristics aside	Cap change ≤ 10% tan δ ≤ 130% Leakage current (I <sub>L</sub> ) < initial limit Impedance (Z) ≤ 130%																																						
<b>Shelf life</b>	After leaving capacitors under no load for 2000 hours at 85°C, when restored at 20°C meet specifications aside	Cap change ≤ ±15% tan δ ≤ 150% Leakage current (I <sub>L</sub> ) < initial limit																																						
<b>Useful life (85°C, V<sub>n</sub>, I<sub>r</sub> applied)</b>	> 15.000 h at 85°C																																							
<b>Operation up to 105°C with voltage derating 0,88 x V rated</b>																																								
<b>Failure percentage</b>	≤ 1% (during useful life)																																							
<b>Failure rate</b>	≤ 33 fit (33 10 <sup>-9</sup> /h)																																							
<b>Self inductance</b>	Approx. 20 nH																																							
<b>Reference standards</b>	CECC 30.300 IEC 60384-4 LONG LIFE GRADE																																							

## K91 TYPE STANDARD RATINGS

Cap µF	Ø x L mm	Tan δ MAX 100 Hz 20°C	ESR TYP mΩ 100 Hz 20°C	Z TYP mΩ 10 kHz 20°C	I <sub>r</sub> a.c. A max 100 Hz 85°C	PART NUMBER stud and insert style excluded
680	51x79	0.08	97	75	5.11	K91400681_M0G079
680	51x105	0.08	97	75	5.74	K91400681_M0G105
1000	51x79	0.08	75	67	6.06	K91400102_M0G079
1000	51x105	0.08	75	67	6.87	K91400102_M0G105
1500	51x105	0.08	53	40	8.18	K91400152_M0G105
1500	63x105	0.08	53	40	9.29	K91400152_M0H105
2200	51x105	0.08	40	31	9.40	K91400222_M0G105
2200	63x105	0.08	40	31	10.70	K91400222_M0H105
2200	76x105	0.08	40	31	12.30	K91400222_M0J105
3300	63x105	0.08	25	16	13.60	K91400332_M0H105
3300	76x105	0.08	25	16	14.50	K91400332_M0J105
3300	76x143	0.08	25	16	16.80	K91400332_M0J143
4700	76x105	0.08	20	15	16.40	K91400472_M0J105
4700	76x143	0.08	20	15	19.50	K91400472_M0J143
5600	76x143	0.08	17	11	20.90	K91400562_M0J143
6800	76x143	0.08	15	10	22.20	K91400682_M0J143
10000	76x143	0.09	13	10	23.00	K91400103_M0J143
10000	76x214	0.09	13	10	28.70	K91400103_M0J214
15000	90x220	0.10	9	8	36.50	K91400153_M0L220

**RATED  
VOLTAGE  
VDC**

**400V**

Cap µF	Ø x L mm	Tan δ MAX 100 Hz 20°C	ESR TYP mΩ 100 Hz 20°C	Z TYP mΩ 10 kHz 20°C	I <sub>r</sub> a.c. A max 100 Hz 85°C	PART NUMBER stud and insert style excluded
680	51x79	0.08	97	75	5.11	K91420681_M0G079
680	51x105	0.08	97	75	5.74	K91420681_M0G105
1000	51x79	0.08	75	67	6.06	K91420102_M0G079
1000	51x105	0.08	75	67	6.87	K91420102_M0G105
1500	51x105	0.08	53	40	8.18	K91420152_M0G105
1500	63x105	0.08	53	40	9.29	K91420152_M0H105
2200	51x105	0.08	40	31	9.40	K91420222_M0G105
2200	63x105	0.08	40	31	10.70	K91420222_M0H105
2200	76x105	0.08	40	31	12.30	K91420222_M0J105
3300	63x105	0.08	25	16	13.60	K91420332_M0H105
3300	76x105	0.08	25	16	14.50	K91420332_M0J105
3300	76x143	0.08	25	16	16.80	K91420332_M0J143
4700	76x105	0.08	20	15	16.40	K91420472_M0J105
4700	76x143	0.08	20	15	19.50	K91420472_M0J143
5600	76x143	0.08	17	11	20.90	K91420562_M0J143
6800	76x143	0.08	15	10	22.20	K91420682_M0J143
10000	76x143	0.09	13	10	23.00	K91420103_M0J143
10000	76x214	0.09	13	10	28.70	K91420103_M0J214
15000	90x220	0.10	9	8	36.50	K91420153_M0L220

**RATED  
VOLTAGE  
VDC**

**420V**

## K91 TYPE STANDARD RATINGS

Cap µF	Ø x L mm	Tan δ MAX 100 Hz 20°C	ESR TYP mΩ 100 Hz 20°C	Z TYP mΩ 10 kHz 20°C	Ir a.c. A max 100 Hz 85°C	PART NUMBER stud and insert style excluded
470	51x79	0.08	159	120	4.36	K91450471_M0G079
680	51x79	0.08	114	105	4.94	K91450681_M0G079
680	51x105	0.08	114	105	5.57	K91450681_M0G105
1000	51x79	0.08	83	70	5.84	K91450102_M0G079
1000	51x105	0.08	83	70	6.60	K91450102_M0G105
1500	51x105	0.08	57	42	7.89	K91450152_M0G105
1500	63x105	0.08	57	42	8.97	K91450152_M0H105
2200	63x105	0.08	44	33	10.20	K91450222_M0H105
2200	76x105	0.08	44	33	11.90	K91450222_M0J105
2200	76x143	0.08	44	33	13.60	K91450222_M0J143
3300	76x105	0.08	30	18	14.00	K91450332_M0J105
3300	76x143	0.08	30	18	16.30	K91450332_M0J143
4700	76x143	0.08	21	15	18.80	K91450472_M0J143
5600	76x143	0.08	18	12	20.20	K91450562_M0J143
6800	76x143	0.08	16	11	21.30	K91450682_M0J143
8200	76x143	0.08	14	10	23.00	K91450822_M0J143
10000	76x143	0.09	13	10	23.10	K91450103_M0J143
10000	76x214	0.09	13	10	26.20	K91450103_M0J214
12000	76x214	0.09	13	10	26.20	K91450123_M0J214
15000	90x220	0.10	11	9	35.00	K91450153_M0L220

**RATED  
VOLTAGE  
VDC**

**450V**

PLEASE TO CONTACT OUR TECHNICAL SERVICE FOR MORE INFORMATION OR SPEC-IN ANALYSIS.

## K92 TYPE -40°C +105°C 5000H

RoHS Compliant

- Design optimized for low equivalent series resistance and high ripple current.
- Surge-proof capacitor in aluminium can with insulation sleeve.
- To be mounted with ring clips or with threaded stud.

### APPLICATIONS

Designed for professional application.  
Switch mode power suppliers, high ripple current converters, motor drives.

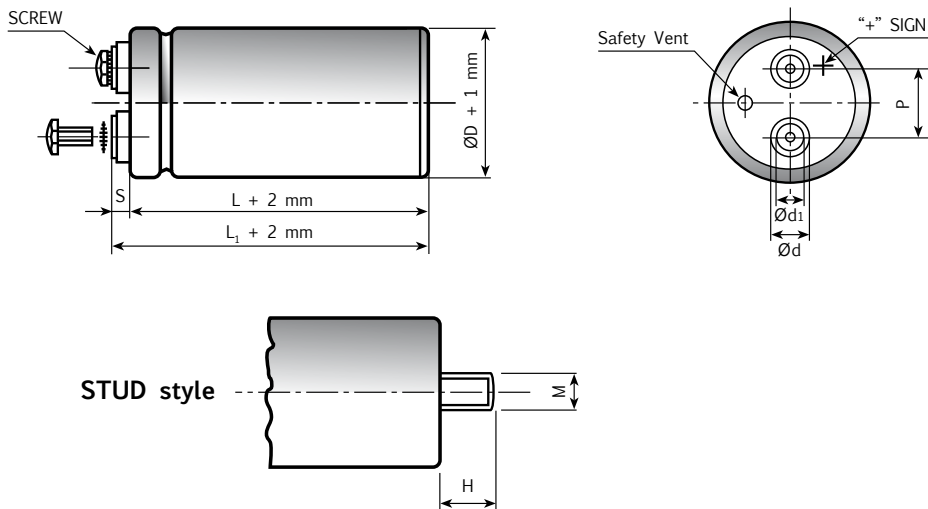

Diagram of dimensions (unit=mm)  
Insert and screw threads: Metric (mm), UNF (inches)

ØD	d	d1	P	STUD M	H	INSERT	SCREW	L <sub>1</sub> -L[-1+3]	S[-1+1]	INSERT STYLE CODE
35	11	7.9	12.7	M8	12	M5	5MA x 9.5	2.5	5	0
51	18.5	13	22.7	M12	16	M5	5MA x 9.5	2.5	5	H
63	18.5	13	28.6	M12	16	M5	5MA x 9.5	2.5	5	H
63	17.3	17.3	28.6	M12	16	UNF 1/4-28 Low Post	1/4-28 x 3/8"	3	4	W
63	17.3	17.3	28.6	M12	16	UNF 1/4-28 High Post	1/4-28 x 1/2"	6	7	R
63	7.9	7.9	28.6	M12	16	UNF 10-32 Low Post	10-32 x 1/4"	2	2.5	Z
63	12	7.9	28.6	M12	16	UNF 10-32 High Post	10-32 x 3/8"	6	7	U
76	18.5	13	31.8	M12	16	M5	5MA x 9.5	2.5	5	H
76	18.5	13	31.8	M12	16	M5	5MA x 9.5	2.5	7	L
76	23.2	17.7	31.8	M12	16	M6	6MA x 10	4.5	7	6
76	17.3	17.3	31.8	M12	16	UNF 1/4-28 Low Post	1/4-28 x 3/8"	3	4	W
76	17.3	17.3	31.8	M12	16	UNF 1/4-28 High Post	1/4-28 x 1/2"	6	7	R
76	7.9	7.9	31.8	M12	16	UNF 10-32 Low Post	10-32 x 1/4"	2	2.5	Z
76	12	7.9	31.8	M12	16	UNF 10-32 High Post	10-32 x 3/8"	6	7	U
90	23.2	17.7	31.8	M12	16	M6	6MA x 10	4.5	7	H



## SPECIFICATIONS

<b>Temperature Range</b>	Operating : -40°C +105°C [ Environmental classification 40/105/56 IEC-68 ] Storage : Preferably below +25°C, not exceeding +40°C																																											
<b>Rated Voltage Range (V<sub>r</sub>)</b>	from 400V to 450V DC																																											
<b>Surge Voltage (V<sub>p</sub>)</b>	V <sub>p</sub> = 1.10 V <sub>r</sub>																																											
<b>Rated Capacitance Range</b>	from 1500 µF to 30000 µF																																											
<b>Capacitance Tolerance</b>	±20% at 100 Hz, 20°C [M class IEC-62] on request : -10% +30% at 100 Hz, 20°C [Q class IEC-62]																																											
<b>Leakage Current (I<sub>L</sub>) (mA, 5 min, 20°C)</b>	max I <sub>L</sub> = 0.006 C <sub>r</sub> V <sub>r</sub> + 4 µA																																											
<b>Ripple current (I<sub>r</sub>)</b>	Refer to table at 105°C and 100Hz : <table style="width: 100%; border-collapse: collapse;"> <tr> <td style="text-align: left;">FREQUENCY</td> <td>50Hz</td> <td>100Hz</td> <td>500Hz</td> <td>1000Hz</td> <td>&gt;10kHz</td> </tr> <tr> <td style="text-align: left;">MULTIPLIER</td> <td>0.8</td> <td>1.0</td> <td>1.2</td> <td>1.3</td> <td>1.5</td> </tr> </table> <table style="width: 100%; border-collapse: collapse;"> <tr> <td style="text-align: left;">AMBIENT TEMP</td> <td>35°C</td> <td>45°C</td> <td>55°C</td> <td>65°C</td> <td>75°C</td> <td>85°C</td> <td>95°C</td> <td>105°C</td> <td>110°C</td> </tr> <tr> <td style="text-align: left;">MULTIPLIER</td> <td>3.0</td> <td>2.8</td> <td>2.6</td> <td>2.4</td> <td>2.2</td> <td>1.8</td> <td>1.5</td> <td>1.0</td> <td>0.5</td> </tr> </table> <p>Due to the current load capability of the contact elements, the following limits must not be exceeded:</p> <table style="width: 100%; border-collapse: collapse;"> <tr> <td style="text-align: left;">CAPACITOR DIAMETER</td> <td>51mm</td> <td>63mm</td> <td>76mm</td> <td>90mm</td> </tr> <tr> <td style="text-align: left;">Maximum current</td> <td>30A</td> <td>40A</td> <td>50A</td> <td>70A</td> </tr> </table>		FREQUENCY	50Hz	100Hz	500Hz	1000Hz	>10kHz	MULTIPLIER	0.8	1.0	1.2	1.3	1.5	AMBIENT TEMP	35°C	45°C	55°C	65°C	75°C	85°C	95°C	105°C	110°C	MULTIPLIER	3.0	2.8	2.6	2.4	2.2	1.8	1.5	1.0	0.5	CAPACITOR DIAMETER	51mm	63mm	76mm	90mm	Maximum current	30A	40A	50A	70A
FREQUENCY	50Hz	100Hz	500Hz	1000Hz	>10kHz																																							
MULTIPLIER	0.8	1.0	1.2	1.3	1.5																																							
AMBIENT TEMP	35°C	45°C	55°C	65°C	75°C	85°C	95°C	105°C	110°C																																			
MULTIPLIER	3.0	2.8	2.6	2.4	2.2	1.8	1.5	1.0	0.5																																			
CAPACITOR DIAMETER	51mm	63mm	76mm	90mm																																								
Maximum current	30A	40A	50A	70A																																								
<b>Insulation Resistance</b>	At 100V DC for 1 min is >100 MΩ across insulating sleeve and terminals.																																											
<b>Vibration Resistance</b>	Frequency range : 10 Hz to 55 Hz, amplitude 0.75 mm Capacitor length ≤ 143 : max acceleration 10g for 3x2 h Capacitor length > 143 : max acceleration 5g for 3x0.5 h																																											
<b>Life test (105°C, V<sub>n</sub>, I<sub>r</sub> applied)</b>	After 2,000 hours application of rated voltage at 105°C capacitors meet characteristics aside	Cap change ≤ 10% tan δ ≤ 130% Leakage current (I <sub>L</sub> ) < initial limit Impedance (Z) ≤ 130%																																										
<b>Shelf life</b>	After leaving capacitors under no load for 500 hours at 105°C, when restored at 20°C meet specifications aside	Cap change ≤ ±15% tan δ ≤ 150% Leakage current (I <sub>L</sub> ) < initial limit																																										
<b>Useful life (105°C, V<sub>n</sub>, I<sub>r</sub> applied)</b>	> 5.000 h at 105°C																																											
<b>Failure percentage Failure rate</b>	≤ 1% (during useful life) ≤ 40 fit (40 10 <sup>-9</sup> /h)																																											
<b>Self inductance</b>	Approx. 20 nH																																											
<b>Reference standards</b>	CECC 30.300 IEC 60384-4 LONG LIFE GRADE																																											

## K92 TYPE STANDARD RATINGS

Cap µF	Ø x L mm	Tan δ MAX 100 Hz 20°C	ESR TYP mΩ 100 Hz 20°C	Z TYP mΩ 10 kHz 20°C	I <sub>r</sub> a.c. A max 100 Hz 105°C	PART NUMBER stud and insert style excluded
470	51x79	0.08	139	112	3.45	K92400471_M0G079
680	51x79	0.08	107	100	3.90	K92400681_M0G079
1000	51x79	0.08	75	67	4.50	K92420102_M0G079
1000	51x105	0.08	75	67	4.90	K92400102_M0G105
1500	63x105	0.08	53	40	6.00	K92400152_M0H105
2200	63x105	0.08	40	31	7.50	K92400222_M0H105
2200	76x105	0.08	40	31	8.50	K92400222_M0J105
3300	76x143	0.08	25	16	11.30	K92400332_M0J143
4700	76x143	0.08	20	15	14.10	K92400472_M0J143
5600	76x143	0.08	17	11	14.30	K92400562_M0J143
6800	76x143	0.08	15	10	18.00	K92400682_M0J143
8200	76x214	0.08	14	10	20.10	K92400822_M0J214
10000	90x220	0.09	13	9	25.10	K92400103_M0L220

**RATED  
VOLTAGE  
VDC**

**400V**

Cap µF	Ø x L mm	Tan δ MAX 100 Hz 20°C	ESR TYP mΩ 100 Hz 20°C	Z TYP mΩ 10 kHz 20°C	I <sub>r</sub> a.c. A max 100 Hz 105°C	PART NUMBER stud and insert style excluded
470	51x79	0.08	139	112	3.45	K92420471_M0G079
680	51x79	0.08	107	100	3.90	K92420681_M0G079
1000	51x79	0.08	75	67	4.50	K92420102_M0G079
1000	51x105	0.08	75	67	4.90	K92420102_M0G105
1500	63x105	0.08	53	40	6.00	K92420152_M0H105
2200	63x105	0.08	40	31	7.50	K92420222_M0H105
2200	76x105	0.08	40	31	8.50	K92420222_M0J105
3300	76x143	0.08	25	16	11.30	K92420332_M0J143
4700	76x143	0.08	20	15	14.10	K92420472_M0J143
5600	76x143	0.08	17	11	14.30	K92420562_M0J143
6800	76x143	0.08	15	10	18.00	K92420682_M0J143
8200	76x214	0.08	14	10	20.10	K92420822_M0J124
10000	90x220	0.09	13	9	25.10	K92420103_M0L220

**RATED  
VOLTAGE  
VDC**

**420V**

## K92 TYPE STANDARD RATINGS

Cap μF	Ø x L mm	Tan δ MAX 100 Hz 20°C	ESR TYP mΩ 100 Hz 20°C	Z TYP mΩ 10 kHz 20°C	I <sub>r</sub> a.c. A max 100 Hz 105°C	PART NUMBER stud and insert style excluded
470	51x79	0.08	159	120	3.20	K92450471_M0G079
680	51x105	0.08	114	105	4.40	K92450681_M0G105
1000	51x105	0.08	83	70	5.10	K92450102_M0G105
1000	63x105	0.08	83	70	5.40	K92450102_M0H105
1500	63x105	0.08	57	42	6.50	K92450152_M0H105
1500	76x105	0.08	57	42	7.20	K92450152_M0J105
2200	76x143	0.08	44	33	9.50	K92450222_M0J143
3300	76x143	0.08	30	18	12.30	K92450332_M0J143
4700	76x143	0.08	21	15	13.20	K92450472_M0J143
5600	76x143	0.08	18	12	14.10	K92450562_M0J143
6800	76x214	0.08	16	11	19.30	K92450682_M0J214
8200	76x214	0.08	15	11	20.10	K92450822_M0J214
10000	90x220	0.09	12	10	26.10	K92450103_M0L220

**RATED  
VOLTAGE  
VDC**

**450V**

PLEASE TO CONTACT OUR TECHNICAL SERVICE FOR MORE INFORMATION OR SPEC-IN ANALYSIS.

# K05 TYPE -40°C +105°C 5000H

RoHS Compliant

- Surge-proof capacitor in aluminium can with insulation sleeve
- Safety vent at bottom case or aside case.
- Snap in terminals for PCB mounting.
- Very high CV for unit volume with low ESR.
- High ripple current, in small dimensions case size.
- Extended temperature range with outstanding reliability.

## APPLICATIONS

Professional switch mode power supplies. Professional power electronics.

Dimensions in mm.

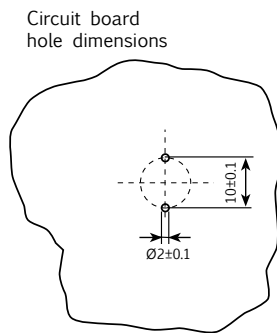
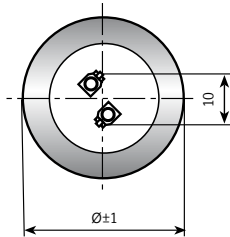
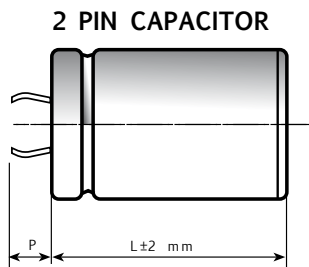

PIN LENGTH  
 P 4.5 short pin  
 P 6.3 long pin (standard)

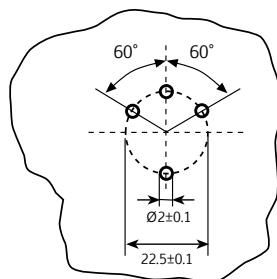
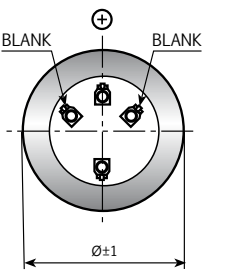
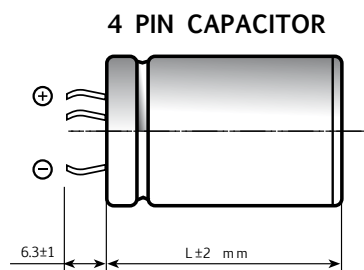
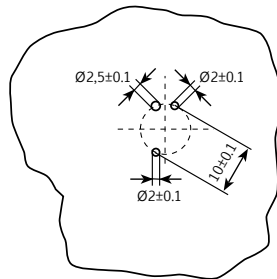
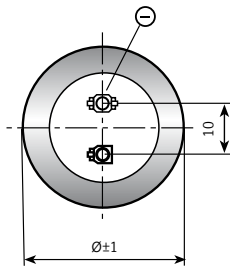
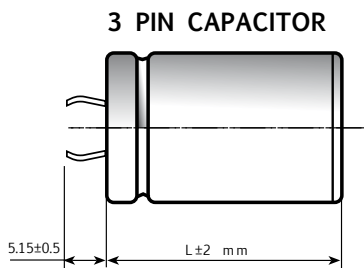

Ø	22	25	30	35	40	45	50
2 PINS	●	●	●	●	●		
3 PINS		●	●	●			
4 PINS				●	●	●	●

On demand, only for capacitors with diam ≥ 35mm: octagonal can shape for long stress vibration applications.

## SPECIFICATIONS

<b>Temperature Range</b>	Operating: -40°C +105°C Storage : Preferably below +25°C, not exceeding +40°C	[Environmental classification 40/105/56 IEC-68]
<b>Rated Voltage Range (V<sub>r</sub>)</b>	from 16V to 500V DC	
<b>Surge Voltage (V<sub>p</sub>)</b>	V <sub>p</sub> = 1.15 V <sub>r</sub> (V <sub>r</sub> ≤ 250V DC) V <sub>p</sub> = 1.10 V <sub>r</sub> (V <sub>r</sub> > 250V DC)	
<b>Rated Capacitance Range</b>	from 68 µF to 47,000 µF	
<b>Capacitance Tolerance</b>	±20% at 100 Hz, 20°C [M class IEC-62]	
<b>Leakage Current (I<sub>L</sub>)</b> (mA, 5 min, 20°C)	max I <sub>L</sub> = 0.006 C <sub>r</sub> V <sub>r</sub> + 4 µA At 85°C max I <sub>L</sub> = 0.02 C <sub>r</sub> V <sub>r</sub> µA	Kendeil product limit : I <sub>L</sub> = 0.003 C <sub>r</sub> V <sub>r</sub>
<b>Ripple current (I<sub>r</sub>)</b>	Refer to table at 105°C and 100Hz. For different temperature and frequency multiplier must be used as follows:	
	FREQUENCY	50Hz 100Hz 500 Hz 1000Hz >10kHz
	MULTIPLIER (0-25V V <sub>r</sub> DC)	0.91 1.0 1.15 1.15 1.2
	MULTIPLIER (40-100V V <sub>r</sub> DC)	0.88 1.0 1.35 1.40 1.45
	MULTIPLIER (160-450V V <sub>r</sub> DC)	0.88 1.0 1.45 1.50 1.55
	AMBIENT TEMP.	35°C 45°C 55°C 65°C 75°C 85°C 95°C 105°C 110°C
	MULTIPLIER	3.0 2.80 2.60 2.40 2.20 1.80 1.50 1.0 0.5
	Maximum internal temperature 108°C	
<b>Insulation Resistance</b>	At 100V DC for 1 min is >100 MΩ across insulating sleeve and terminals.	
<b>Vibration Resistance</b>	Frequency range: 10 Hz to 500 Hz, amplitude 0.75 mm max acceleration 10g for 3x2 h	
<b>Life test</b>	After 2,000 hours application of rated voltage at 105°C capacitors meet characteristics aside	Cap change ≤ 20% tan δ ≤ 200% Leakage current (I <sub>L</sub> ) < initial limit Impedance (Z) ≤ 200%
<b>Shelf life</b>	After leaving capacitors under no load for 500 hours at 105°C, when restored at 20°C meet specifications aside	Cap change ≤ ±15% tan δ ≤ 150% Leakage current (I <sub>L</sub> ) < initial limit
<b>Useful life</b> (V <sub>n</sub> , Temp rated I ripple applied)	250,000 h at 40°C 15,000 h at 85°C 5,000 h at 105°C	
<b>Failure percentage</b> <b>Failure rate</b>	≤ 1% (during useful life) ≤ 30 fit (30 10 <sup>-9</sup> /h) (V <sub>r</sub> ≤ 160V DC) ≤ 40 fit (40 10 <sup>-9</sup> /h) (V <sub>r</sub> > 160V DC)	
<b>Self inductance</b>	Approx. 20 nH	
<b>Reference standards</b>	CECC 30.301 - IEC 60384-4 LONG LIFE GRADE	

## K05 TYPE STANDARD RATINGS

Cap $\mu\text{F}$	$\varnothing \times L$ mm	Tan $\delta$ MAX 100 Hz 20°C	ESR TYP m $\Omega$ 100 Hz 20°C	Z TYP m $\Omega$ 10 kHz 20°C	I <sub>r</sub> a.c. A max 100 Hz 105°C	PART NUMBER termination digit excluded
6800	25x30	0.30	55	40	1.9	K05016682_PM0C030
10000	25x40	0.40	45	35	2.0	K05016103_PM0C040
10000	30x30	0.40	40	35	2.0	K05016103_PM0D030
15000	25x40	0.45	40	35	2.6	K05016153_PM0C040
15000	30x40	0.45	40	35	2.8	K05016153_PM0D040
22000	30x40	0.60	35	24	3.1	K05016223_PM0D040
22000	35x40	0.60	35	24	3.3	K05016223_PM0E040
33000	35x50	0.70	25	20	3.6	K05016333_PM0E050
47000	35x50	0.90	22	20	4.9	K05016473_PM0E050

**RATED  
VOLTAGE  
VDC**

**16V**

Cap $\mu\text{F}$	$\varnothing \times L$ mm	Tan $\delta$ MAX 100 Hz 20°C	ESR TYP m $\Omega$ 100 Hz 20°C	Z TYP m $\Omega$ 10 kHz 20°C	I <sub>r</sub> a.c. A max 100 Hz 105°C	PART NUMBER termination digit excluded
4700	25x30	0.25	53	45	1.8	K05025472_PM0C030
6800	25x30	0.25	50	38	2.0	K05025682_PM0C030
6800	30x30	0.30	50	38	2.2	K05025682_PM0D030
10000	25x40	0.40	40	35	2.4	K05025103_PM0C040
10000	30x30	0.40	40	35	2.3	K05025103_PM0D030
15000	30x40	0.45	39	28	2.9	K05025153_PM0D040
15000	35x40	0.45	39	28	3.2	K05025153_PM0E040
22000	35x50	0.60	30	22	3.3	K05025223_PM0E050
33000	35x50	0.70	22	18	4.3	K05025333_PM0E050

**RATED  
VOLTAGE  
VDC**

**25V**

Cap $\mu\text{F}$	$\varnothing \times L$ mm	Tan $\delta$ MAX 100 Hz 20°C	ESR TYP m $\Omega$ 100 Hz 20°C	Z TYP m $\Omega$ 10 kHz 20°C	I <sub>r</sub> a.c. A max 100 Hz 105°C	PART NUMBER termination digit excluded
3300	25x30	0.20	72	58	1.5	K05040332_PM0C030
4700	25x30	0.20	50	38	1.8	K05040472_PM0C030
4700	30x25	0.20	50	38	1.8	K05040472_PM0D025
6800	25x40	0.30	48	33	2.3	K05040682_PM0C040
6800	30x30	0.30	48	33	2.4	K05040682_PM0D030
10000	30x40	0.40	39	28	2.8	K05040103_PM0D040
10000	35x30	0.40	39	28	2.9	K05040103_PM0E030
10000	35x40	0.40	39	28	3.1	K05040103_PM0E040
15000	30x40	0.45	32	22	2.8	K05040153_PM0D040
15000	35x40	0.45	32	22	3.7	K05040153_PM0E040
22000	35x40	0.55	28	20	5.1	K05040223_PM0E040
22000	35x50	0.55	28	20	5.4	K05040223_PM0E050

**RATED  
VOLTAGE  
VDC**

**40V**

## K05 TYPE STANDARD RATINGS

Cap $\mu\text{F}$	$\varnothing \times L$ mm	Tan $\delta$ MAX 100 Hz 20°C	ESR TYP m $\Omega$ 100 Hz 20°C	Z TYP m $\Omega$ 10 kHz 20°C	I <sub>r</sub> a.c. A max 100 Hz 105°C	PART NUMBER termination digit excluded
2200	25x30	0.20	72	58	1.5	K05050222_PM0C030
3300	25x30	0.20	48	38	1.6	K05050332_PM0C030
4700	25x30	0.20	50	35	2.0	K05050472_PM0C030
4700	30x25	0.20	50	35	2.0	K05050472_PM0D025
6800	30x30	0.30	46	28	2.9	K05050682_PM0D030
6800	30x40	0.30	46	28	3.2	K05050682_PM0D040
10000	30x40	0.35	31	22	3.4	K05050103_PM0D040
10000	35x30	0.35	31	22	3.2	K05050103_PM0E030
15000	35x50	0.45	26	18	4.7	K05050153_PM0E050
22000	40x50	0.50	25	18	5.5	K05050223_PM0F050

**RATED  
VOLTAGE  
VDC**

**50V**

Cap $\mu\text{F}$	$\varnothing \times L$ mm	Tan $\delta$ MAX 100 Hz 20°C	ESR TYP m $\Omega$ 100 Hz 20°C	Z TYP m $\Omega$ 10 kHz 20°C	I <sub>r</sub> a.c. A max 100 Hz 105°C	PART NUMBER termination digit excluded
2200	25x30	0.15	79	60	1.5	K05063222_PM0C030
3300	25x40	0.15	50	40	2.3	K05063332_PM0C040
3300	30x30	0.15	50	40	2.1	K05063332_PM0D030
4700	25x40	0.20	40	29	2.2	K05063472_PM0C040
4700	30x30	0.20	40	29	2.4	K05063472_PM0D030
4700	30x40	0.20	40	29	2.8	K05063472_PM0D040
6800	30x40	0.30	35	25	3.0	K05063682_PM0D040
6800	35x40	0.30	35	25	4.4	K05063682_PM0E040
10000	35x50	0.35	30	23	5.3	K05063103_PM0E050

**RATED  
VOLTAGE  
VDC**

**63V**

Cap $\mu\text{F}$	$\varnothing \times L$ mm	Tan $\delta$ MAX 100 Hz 20°C	ESR TYP m $\Omega$ 100 Hz 20°C	Z TYP m $\Omega$ 10 kHz 20°C	I <sub>r</sub> a.c. A max 100 Hz 105°C	PART NUMBER termination digit excluded
1000	22x30	0.10	127	100	1.3	K05100102_PM0B030
1000	25x30	0.10	127	100	1.7	K05100102_PM0C030
1000	30x25	0.10	127	100	1.7	K05100102_PM0D025
1500	25x40	0.12	105	82	2.0	K05100152_PM0C040
1500	30x30	0.12	105	82	1.8	K05100152_PM0D030
2200	30x30	0.15	71	60	2.7	K05100222_PM0D030
2200	30x40	0.15	71	60	2.7	K05100222_PM0D040
3300	30x50	0.15	48	39	3.0	K05100332_PM0D050
3300	35x40	0.15	48	39	3.3	K05100332_PM0E040
4700	35x40	0.15	42	30	3.6	K05100472_PM0E040
4700	35x50	0.20	33	26	4.4	K05100472_PM0E050
5600	35x50	0.20	33	24	4.5	K05100562_PM0E050
5600	40x50	0.20	33	24	4.8	K05100562_PM0F050
6800	35x50	0.20	32	23	4.5	K05100682_PM0E050
6800	40x50	0.20	33	24	4.9	K05100682_PM0F050

**RATED  
VOLTAGE  
VDC**

**100V**

## K05 TYPE STANDARD RATINGS

Cap $\mu\text{F}$	$\varnothing \times L$ mm	Tan $\delta$ MAX 100 Hz 20°C	ESR TYP m $\Omega$ 100 Hz 20°C	Z TYP m $\Omega$ 10 kHz 20°C	I <sub>r</sub> a.c. A max 100 Hz 105°C	PART NUMBER termination digit excluded
220	22x30	0.10	440	340	0.9	K05200221_PM0B030
220	25x30	0.10	440	340	1.1	K05200221_PM0C030
330	22x30	0.10	240	133	1.1	K05200331_PM0B030
330	25x25	0.10	240	133	0.7	K05200331_PM0C025
330	25x30	0.10	240	133	1.2	K05200331_PM0C030
470	25x30	0.10	169	98	1.6	K05200471_PM0C030
680	25x40	0.10	145	87	1.7	K05200681_PM0C040
680	30x40	0.10	145	87	2.0	K05200681_PM0D040
1000	30x40	0.10	95	63	2.1	K05200102_PM0D040
1000	35x30	0.10	95	63	2.4	K05200102_PM0E030
1500	30x50	0.10	70	41	2.4	K05200152_PM0D050
1500	35x50	0.10	70	41	2.6	K05200152_PM0E050
2200	35x50	0.12	45	33	2.8	K05200222_PM0E050

**RATED  
VOLTAGE  
VDC**

**200V**

Cap $\mu\text{F}$	$\varnothing \times L$ mm	Tan $\delta$ MAX 100 Hz 20°C	ESR TYP m $\Omega$ 100 Hz 20°C	Z TYP m $\Omega$ 10 kHz 20°C	I <sub>r</sub> a.c. A max 100 Hz 105°C	PART NUMBER termination digit excluded
100	25x30	0.10	950	730	0.7	K05250101_PM0C030
150	25x30	0.10	530	290	0.7	K05250151_PM0C030
220	25x30	0.10	370	240	0.9	K05250221_PM0C030
330	30x30	0.10	260	153	1.2	K05250331_PM0D030
470	25x40	0.10	180	110	1.5	K05250471_PM0C040
470	30x30	0.10	180	110	1.5	K05250471_PM0D030
680	35x40	0.10	145	95	1.8	K05250681_PM0E040
1000	35x40	0.10	98	65	2.0	K05250102_PM0E040
1000	35x50	0.10	98	65	2.6	K05250102_PM0E050
1500	35x50	0.12	75	43	2.8	K05250152_PM0E050

**RATED  
VOLTAGE  
VDC**

**250V**

PLEASE TO CONTACT OUR TECHNICAL SERVICE FOR MORE INFORMATION OR SPEC-IN ANALYSIS.



## K05 TYPE STANDARD RATINGS

Cap µF	Ø x L mm	Tan δ MAX 100 Hz 20°C	ESR TYP m Ω 100 Hz 20°C	Z TYP m Ω 10 kHz 20°C	I <sub>r</sub> a.c. A max 100 Hz 105°C	PART NUMBER termination digit excluded
68	22x30	0.10	1405	1050	0.47	K05400680_PM0B030
100	22x30	0.10	796	550	0.5	K05400101_PM0B030
100	25x30	0.10	796	550	0.5	K05400101_PM0C030
150	25x30	0.10	530	380	0.6	K05400151_PM0C030
150	30x30	0.10	530	380	0.8	K05400151_PM0D030
220	25x40	0.10	360	250	1.0	K05400221_PM0C040
220	30x30	0.10	360	250	1.1	K05400221_PM0D030
270	25x40	0.10	320	199	1.2	K05400271_PM0C040
330	25x45	0.10	249	170	1.3	K05400331_PM0C045
330	30x40	0.10	240	170	1.4	K05400331_PM0D040
330	35x30	0.10	240	170	1.4	K05400331_PM0E030
470	30x50	0.10	170	125	1.9	K05400471_PM0D050
470	35x40	0.10	170	125	1.9	K05400471_PM0E040
470	35x50	0.10	170	125	2.2	K05400471_PM0E050
680	35x50	0.10	158	110	2.2	K05400681_PM0E050
680	40x50	0.10	158	110	2.4	K05400681_PM0F050
820	35x60	0.10	121	97	2.5	K05400821_PM0E060
1000	40x60	0.10	110	90	3.1	K05400102_PM0F060
1500	40X97	0.10	99	68	5.8	K05400152_PM0F097

**RATED  
VOLTAGE  
VDC**

**400V**

Cap µF	Ø x L mm	Tan δ MAX 100 Hz 20°C	ESR TYP m Ω 100 Hz 20°C	Z TYP m Ω 10 kHz 20°C	I <sub>r</sub> a.c. A max 100 Hz 105°C	PART NUMBER termination digit excluded
68	22x30	0.10	1405	1050	0.47	K05450680_PM0B030
100	25x30	0.10	796	710	0.5	K05450101_PM0C030
100	30x25	0.10	796	550	0.7	K05450101_PM0D025
100	30x30	0.10	796	550	0.8	K05450101_PM0D030
150	25x40	0.10	660	490	0.9	K05450151_PM0C040
150	30x30	0.10	530	380	0.8	K05450151_PM0D030
150	30x40	0.10	530	380	1.0	K05450151_PM0D040
220	25x50	0.10	380	310	0.9	K05450221_PM0C050
220	30x40	0.10	360	250	1.1	K05450221_PM0D040
220	35x30	0.10	360	250	1.0	K05450221_PM0E030
330	30x50	0.10	240	170	1.25	K05450331_PM0D050
330	35x40	0.10	240	170	1.3	K05450331_PM0E040
330	35x50	0.10	240	170	1.4	K05450331_PM0E050
470	35x50	0.10	170	125	1.8	K05450471_PM0E050
680	35x50	0.15	160	116	2.1	K05450681_PM0E050
680	35x60	0.12	158	110	2.2	K05450681_PM0E060
820	40x60	0.13	125	100	2.3	K05450821_PM0F060
1000	40x60	0.13	110	90	3.2	K05450102_PM0F060
1500	40X97	0.15	90	80	5.1	K05450152_PM0F097

**RATED  
VOLTAGE  
VDC**

**450V**

## K05 TYPE STANDARD RATINGS

Cap $\mu\text{F}$	$\varnothing \times L$ mm	Tan $\delta$ MAX 100 Hz 20°C	ESR TYP m $\Omega$ 100 Hz 20°C	Z TYP m $\Omega$ 10 kHz 20°C	I <sub>r</sub> a.c. A max 100 Hz 105°C	PART NUMBER termination digit excluded
68	25x30	0.10	1490	1070	0.42	K05500680_PM0C030
100	30x30	0.10	935	620	0.55	K05500101_PM0D030
150	30x40	0.10	620	410	0.75	K05500151_PM0D040
180	30x50	0.10	512	340	0.90	K05500181_PM0D050
220	35x40	0.10	455	295	0.95	K05500221_PM0E040
270	35x50	0.11	320	214	1.60	K05500271_PM0E050
330	35x50	0.11	296	203	1.65	K05500331_PM0E050
330	35x60	0.11	296	203	1.78	K05500331_PM0E060
330	40x50	0.11	296	203	1.80	K05500331_PM0F050
470	40x60	0.13	211	156	2.00	K05500471_PM0F060

**RATED  
VOLTAGE  
VDC**

**500V**

# K06 TYPE -40°C +85°C 5000H

RoHS Compliant

- Surge-proof capacitor in aluminium can with insulation sleeve
- Safety vent at bottom case or aside case.
- Snap in terminals for PCB mounting.
- Very high CV for unit volume with low ESR.
- High ripple current, in small dimensions case size.
- Operation up to 105°C permissible..

## APPLICATIONS

Professional switch mode power supplies. Professional power electronics.

Dimensions in mm.

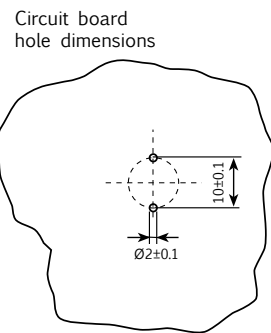
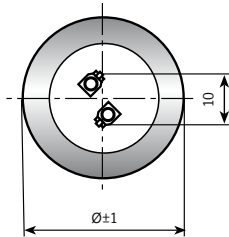
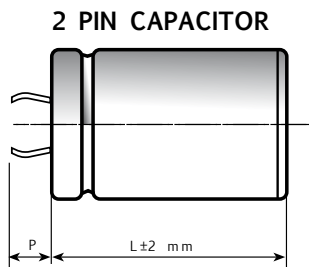

PIN LENGTH  
 P 4.5 short pin  
 P 6.3 long pin (standard)

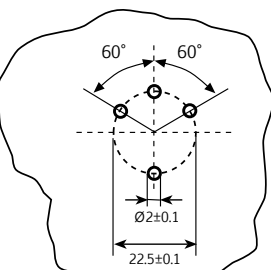
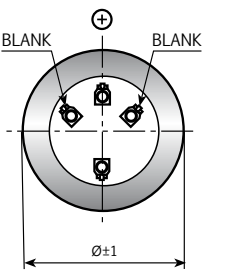
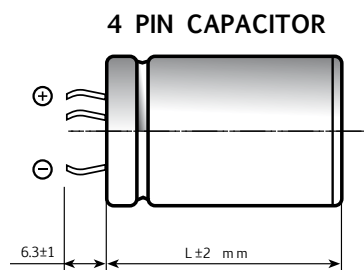
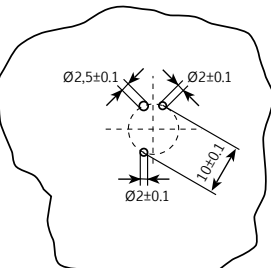
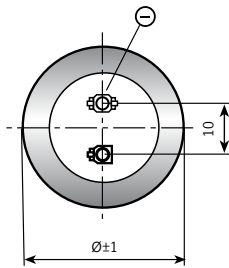
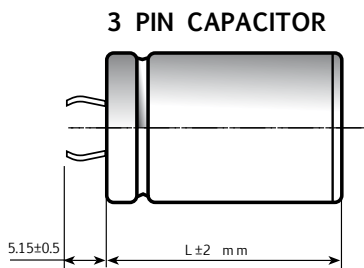

Ø	22	25	30	35	40	45	50
2 PINS	●	●	●	●	●		
3 PINS		●	●	●			
4 PINS				●	●	●	●

On demand, only for capacitors with diam ≥ 35mm: octagonal can shape for long stress vibration applications.

## SPECIFICATIONS

<b>Temperature Range</b>	Operating: -40°C +85°C Storage : Preferably below +25°C, not exceeding +40°C	[Environmental classification 40/85/56 IEC-68]						
<b>Rated Voltage Range (V<sub>r</sub>)</b>	from 16V to 600V DC							
<b>Surge Voltage (V<sub>p</sub>)</b>	$V_p = 1.05 V_r$ ( $V_r > 450V$ DC) $V_p = 1.15 V_r$ ( $V_r \leq 250V$ DC) $V_p = 1.10 V_r$ ( $V_r > 250V$ DC)							
<b>Rated Capacitance Range</b>	from 68 $\mu$ F to 47000 $\mu$ F							
<b>Capacitance Tolerance</b>	$\pm 20\%$ at 100 Hz, 20°C [M class IEC-62]							
<b>Leakage Current (I<sub>L</sub>)</b> (mA, 5 min, 20°C)	max I <sub>L</sub> = 0.006 C <sub>r</sub> V <sub>r</sub> + 4 $\mu$ A Kendeil product limit : I <sub>L</sub> = 0.003 C <sub>r</sub> V <sub>r</sub> At 85°C max I <sub>L</sub> = 0.04 C <sub>r</sub> V <sub>r</sub> $\mu$ A							
<b>Ripple current (I<sub>r</sub>)</b>	Refer to table at 85°C and 100Hz For different temperature and frequency multiplier must be used as follows:							
	FREQUENCY	50Hz	100Hz	500 Hz	1000Hz	>10kHz		
	MULTIPLIER (0-25V V <sub>r</sub> DC)	0.91	1.0	1.15	1.15	1.2		
	MULTIPLIER (40-100V V <sub>r</sub> DC)	0.88	1.0	1.35	1.40	1.45		
	MULTIPLIER (160-450V V <sub>r</sub> DC)	0.88	1.0	1.45	1.50	1.55		
	AMBIENT TEMP.	35°C	45°C	55°C	65°C	75°C	85°C	95°C
	MULTIPLIER	2.2	2.1	1.8	1.6	1.4	1.0	0.5
	Maximum internal temperature	98°C						
<b>Insulation Resistance</b>	At 100V DC for 1 min is >100 M $\Omega$ across insulating sleeve and terminals.							
<b>Vibration Resistance</b>	Frequency range: 10 Hz to 500 Hz, amplitude 0.75 mm max acceleration 10g for 3x2 h							
<b>Life test</b>	After 2,000 hours application of rated voltage at 85°C capacitors meet characteristics aside	Cap change	$\leq 20\%$					
		tan $\delta$	$\leq 200\%$					
		Leakage current (I <sub>L</sub> )	< initial limit					
		Impedance (Z)	$\leq 200\%$					
<b>Shelf life</b>	After leaving capacitors under no load for 500 hours at 85°C, when restored at 20°C meet specifications aside	Cap change	$\leq \pm 15\%$					
		tan $\delta$	$\leq 150\%$					
		Leakage current (I <sub>L</sub> )	< initial limit					
<b>Useful life</b> (V <sub>n</sub> , Temp rated I ripple applied)	$> 200,000$ h at 40°C $> 5,000$ h at 85°C							
<b>Failure percentage</b>	$\leq 1\%$ (during useful life)							
<b>Failure rate</b>	$\leq 25$ fit (25 $10^{-9}$ /h)	(V <sub>r</sub> $\leq 160V$ DC)						
	$\leq 33$ fit (33 $10^{-9}$ /h)	(V <sub>r</sub> $> 160V$ DC)						
<b>Self inductance</b>	Approx. 20 nH							
<b>Reference standards</b>	CECC 30.301 - IEC 60384-4 LONG LIFE GRADE							

## K06 TYPE STANDARD RATINGS

Cap $\mu\text{F}$	$\varnothing \times L$ mm	Tan $\delta$ MAX 100 Hz 20°C	ESR TYP m $\Omega$ 100 Hz 20°C	Z TYP m $\Omega$ 10 kHz 20°C	Ir a.c. A max 100 Hz 85°C	PART NUMBER termination digit excluded
4700	22x30	0.30	55	40	1.5	K06016472_PM0B030
6800	22x30	0.30	45	38	1.8	K06016682_PM0B030
10000	25x30	0.40	40	35	2.4	K06016103_PM0C030
15000	30x30	0.45	33	25	2.6	K06016153_PM0D030
22000	30x40	0.60	27	22	3.5	K06016223_PM0D040
22000	35x30	0.60	27	22	3.5	K06016223_PM0E030
22000	35x40	0.60	27	22	3.5	K06016223_PM0E040
33000	35x50	0.70	25	20	4.8	K06016333_PM0E050
47000	35x50	0.90	22	20	5.8	K06016473_PM0E050

**RATED  
VOLTAGE  
VDC**

**16V**

Cap $\mu\text{F}$	$\varnothing \times L$ mm	Tan $\delta$ MAX 100 Hz 20°C	ESR TYP m $\Omega$ 100 Hz 20°C	Z TYP m $\Omega$ 10 kHz 20°C	Ir a.c. A max 100 Hz 85°C	PART NUMBER termination digit excluded
4700	22x30	0.20	53	45	1.8	K06025472_PM0B030
6800	25x30	0.25	50	38	2.7	K06025682_PM0C030
10000	25x40	0.40	40	35	3.3	K06025103_PM0C040
10000	30x30	0.40	40	35	3.3	K06025103_PM0D030
15000	30x40	0.45	39	28	4.1	K06025153_PM0D040
15000	35x30	0.45	39	28	4.1	K06025153_PM0E030
22000	35x40	0.60	30	22	5.0	K06025223_PM0E040
33000	35x50	0.70	22	18	6.1	K06025333_PM0E050

**RATED  
VOLTAGE  
VDC**

**25V**

Cap $\mu\text{F}$	$\varnothing \times L$ mm	Tan $\delta$ MAX 100 Hz 20°C	ESR TYP m $\Omega$ 100 Hz 20°C	Z TYP m $\Omega$ 10 kHz 20°C	Ir a.c. A max 100 Hz 85°C	PART NUMBER termination digit excluded
3300	22x30	0.15	72	58	2.1	K06040332_PM0B030
4700	25x30	0.20	50	38	2.8	K06040472_PM0C030
6800	25x40	0.30	48	33	3.4	K06040682_PM0C040
6800	30x30	0.30	48	33	3.4	K06040682_PM0D030
10000	25x40	0.40	38	28	3.8	K06040103_PM0C040
10000	30x40	0.40	39	28	4.3	K06040103_PM0D040
10000	35x30	0.40	39	28	4.3	K06040103_PM0E030
15000	30x40	0.45	32	22	4.0	K06040153_PM0D040
15000	35x40	0.45	32	22	4.8	K06040153_PM0E040
22000	35x50	0.60	28	20	5.4	K06040223_PM0E050

**RATED  
VOLTAGE  
VDC**

**40V**

## K06 TYPE STANDARD RATINGS

Cap $\mu\text{F}$	$\varnothing \times L$ mm	Tan $\delta$ MAX 100 Hz 20°C	ESR TYP m $\Omega$ 100 Hz 20°C	Z TYP m $\Omega$ 10 kHz 20°C	I <sub>r</sub> a.c. A max 100 Hz 85°C	PART NUMBER termination digit excluded
2200	22x30	0.20	72	58	1.9	K06050222_PM0B030
3300	25x30	0.20	48	38	2.5	K06050332_PM0C030
4700	25x30	0.20	50	35	2.8	K06050472_PM0C030
6800	25x40	0.30	48	28	3.2	K06050682_PM0C040
6800	30x30	0.30	48	28	3.2	K06050682_PM0D030
10000	30x40	0.35	31	22	3.8	K06050103_PM0D040
10000	35x30	0.35	31	28	3.8	K06050103_PM0E030
10000	35x40	0.35	31	28	4.1	K06050103_PM0E040
15000	35x50	0.45	26	18	4.9	K06050153_PM0E050
22000	40x50	0.50	25	18	7.3	K06050223_PM0F050

**RATED  
VOLTAGE  
VDC**

**50V**

Cap $\mu\text{F}$	$\varnothing \times L$ mm	Tan $\delta$ MAX 100 Hz 20°C	ESR TYP m $\Omega$ 100 Hz 20°C	Z TYP m $\Omega$ 10 kHz 20°C	I <sub>r</sub> a.c. A max 100 Hz 85°C	PART NUMBER termination digit excluded
2200	25x30	0.20	79	58	2.2	K06063222_PM0C030
3300	25x40	0.20	50	38	2.6	K06063332_PM0C040
3300	30x30	0.20	50	38	2.6	K06063332_PM0D030
4700	25x40	0.20	41	29	2.8	K06063472_PM0C040
4700	30x40	0.20	41	29	3.5	K06063472_PM0D040
4700	35x30	0.20	41	29	3.5	K06063472_PM0E030
6800	30x40	0.30	35	25	3.6	K06063682_PM0D040
6800	35x40	0.30	35	25	4.0	K06063682_PM0E040
10000	35x50	0.35	32	23	5.8	K06063103_PM0E050
15000	40x50	0.45	30	20	6.8	K06063153_PM0F050

**RATED  
VOLTAGE  
VDC**

**63V**

Cap $\mu\text{F}$	$\varnothing \times L$ mm	Tan $\delta$ MAX 100 Hz 20°C	ESR TYP m $\Omega$ 100 Hz 20°C	Z TYP m $\Omega$ 10 kHz 20°C	I <sub>r</sub> a.c. A max 100 Hz 85°C	PART NUMBER termination digit excluded
1000	22x30	0.12	150	100	1.3	K06100102_PM0B030
1000	25x30	0.12	150	100	1.6	K06100102_PM0C030
1000	30x25	0.12	150	100	1.6	K06100102_PM0D025
1500	30x30	0.12	105	82	2.1	K06100152_PM0D030
2200	30x30	0.15	71	60	2.4	K06100222_PM0D030
2200	30x40	0.15	71	60	3.1	K06100222_PM0D040
2200	35x30	0.15	71	60	2.4	K06100222_PM0E030
3300	30x50	0.20	48	39	4.0	K06100332_PM0D050
3300	35x40	0.20	48	39	4.0	K06100332_PM0E040
4700	35x50	0.20	33	26	5.6	K06100472_PM0E050
6800	35x50	0.25	33	25	5.8	K06100682_PM0E050

**RATED  
VOLTAGE  
VDC**

**100V**

## K06 TYPE STANDARD RATINGS

Cap $\mu\text{F}$	$\varnothing \times L$ mm	Tan $\delta$ MAX 100 Hz 20°C	ESR TYP m $\Omega$ 100 Hz 20°C	Z TYP m $\Omega$ 10 kHz 20°C	Ir a.c. A max 100 Hz 85°C	PART NUMBER termination digit excluded
220	22x30	0.10	440	340	0.9	K06200221_PM0B030
330	22x30	0.10	240	133	1.3	K06200331_PM0B030
470	25x30	0.10	169	98	1.5	K06200471_PM0C030
680	25x40	0.10	145	87	2.0	K06200681_PM0C040
680	30x30	0.10	145	87	2.0	K06200681_PM0D030
680	35x30	0.10	145	87	2.0	K06200681_PM0E030
1000	30x40	0.10	95	63	2.6	K06200102_PM0D040
1000	35x40	0.10	95	63	2.8	K06200102_PM0E040
1500	35x40	0.10	70	41	2.9	K06200152_PM0E040
1500	35x50	0.10	70	41	3.7	K06200152_PM0E050
2200	35x50	0.10	45	33	3.90	K06200222_PM0E050

**RATED  
VOLTAGE  
VDC**

**200V**

Cap $\mu\text{F}$	$\varnothing \times L$ mm	Tan $\delta$ MAX 100 Hz 20°C	ESR TYP m $\Omega$ 100 Hz 20°C	Z TYP m $\Omega$ 10 kHz 20°C	Ir a.c. A max 100 Hz 85°C	PART NUMBER termination digit excluded
150	22x30	0.12	530	290	0.9	K06250151_PM0B030
220	25x30	0.12	370	240	1.3	K06250221_PM0C030
330	25x40	0.12	260	153	1.4	K06250331_PM0C040
330	30x30	0.12	260	153	1.4	K06250331_PM0D030
470	25x40	0.12	180	110	1.6	K06250471_PM0C040
470	30x30	0.12	180	110	1.6	K06250471_PM0D030
680	30x40	0.12	145	95	1.9	K06250681_PM0D040
680	35x40	0.12	145	95	2.2	K06250681_PM0E040
1000	35x40	0.12	98	65	2.6	K06250102_PM0E040
1000	35x50	0.12	98	65	3.20	K06250102_PM0E050
1500	35x50	0.15	75	43	4.00	K06250152_PM0E050
2200	40x50	0.15	50	35	5.20	K06250222_PM0F050

**RATED  
VOLTAGE  
VDC**

**250V**

## K06 TYPE STANDARD RATINGS

**RATED  
VOLTAGE  
VDC**

**400V**

Cap µF	Ø x L mm	Tan δ MAX 100 Hz 20°C	ESR TYP m Ω 100 Hz 20°C	Z TYP m Ω 10 kHz 20°C	Ir a.c. A max 100 Hz 85°C	PART NUMBER termination digit excluded
68	22x25	0.10	1405	1050	0.6	K06400680_PM0B025
68	22x30	0.10	1405	1050	0.6	K06400680_PM0B030
100	22x30	0.10	796	550	0.7	K06400101_PM0B030
100	25x25	0.10	796	550	0.7	K06400101_PM0C025
100	25x30	0.10	796	550	1.0	K06400101_PM0C030
150	25x30	0.10	530	380	1.0	K06400151_PM0C030
150	30x25	0.10	530	380	1.0	K06400151_PM0D025
220	25x40	0.10	360	250	1.2	K06400221_PM0C040
220	30x30	0.10	360	250	1.2	K06400221_PM0D030
330	30x40	0.10	240	170	1.7	K06400331_PM0D040
330	35x30	0.10	240	170	1.7	K06400331_PM0E030
470	35x40	0.10	170	125	2.2	K06400471_PM0E040
470	35x50	0.10	170	125	2.60	K06400471_PM0E040
560	35x50	0.10	165	122	2.60	K06400561_PM0E050
680	35x50	0.10	158	110	2.80	K06400681_PM0E050
680	40x50	0.10	158	110	3.20	K06400681_PM0F050
820	35x60	0.10	140	106	3.50	K06400821_PM0E060
1000	35x60	0.12	103	91	4.40	K06400102_PM0E060
1500	40x97	0.12	65	50	5.79	K06400152_PM0F097

**RATED  
VOLTAGE  
VDC**

**450V**

Cap µF	Ø x L mm	Tan δ MAX 100 Hz 20°C	ESR TYP m Ω 100 Hz 20°C	Z TYP m Ω 10 kHz 20°C	Ir a.c. A max 100 Hz 85°C	PART NUMBER termination digit excluded
68	22x25	0.12	1405	1050	0.6	K06450680_PM0B025
68	22x30	0.12	1405	1050	0.6	K06450680_PM0B030
100	25x30	0.12	800	560	0.7	K06450101_PM0C030
100	30x25	0.12	800	560	0.7	K06450101_PM0D025
150	30x25	0.12	550	400	1.1	K06450151_PM0D025
150	30x30	0.12	550	400	1.1	K06450151_PM0D030
220	30x40	0.12	380	265	1.3	K06450221_PM0D040
220	35x30	0.12	380	265	1.3	K06450221_PM0E030
330	30x50	0.12	255	175	1.7	K06450331_PM0D050
330	35x40	0.12	255	175	1.7	K06450331_PM0E040
470	35x50	0.12	175	125	2.40	K06450471_PM0E050
560	35x50	0.12	165	122	2.50	K06450561_PM0E050
680	35x50	0.12	158	110	2.60	K06450681_PM0E050
680	40x50	0.12	158	110	3.10	K06450681_PM0F050
820	40x60	0.12	110	95	4.00	K06450821_PM0F060
1000	40x77	0.12	110	95	4.90	K06450102_PM0F077
1500	40x97	0.12	110	95	5.56	K06450152_PM0F097



## K06 TYPE STANDARD RATINGS

Cap $\mu\text{F}$	$\varnothing \times L$ mm	Tan $\delta$ MAX 100 Hz 20°C	ESR TYP m $\Omega$ 100 Hz 20°C	Z TYP m $\Omega$ 10 kHz 20°C	Ir a.c. A max 100 Hz 85°C	PART NUMBER termination digit excluded
68	25x30	0.15	1870	1380	0.60	K06500680_PM0C030
100	30x30	0.15	1050	790	0.70	K06500101_PM0D030
150	30x40	0.15	750	580	1.10	K06500151_PM0D040
220	30x50	0.15	579	440	1.40	K06500221_PM0D050
220	35x40	0.15	579	440	1.40	K06500221_PM0E040
330	35x50	0.15	386	290	2.10	K06500331_PM0E050
470	40x50	0.15	271	200	2.50	K06500471_PM0F050
560	40x60	0.15	230	190	3.00	K06500561_PM0F060
680	40x77	0.15	205	155	3.50	K06500681_PM0F077
820	40x97	0.15	141	119	3.90	K06500821_PM0F097
1000	40x77	0.15	135	112	4.00	K06500102_PM0F077
1200	40x97	0.15	125	105	4.90	K06500122_PM0F097
1500	45x97	0.15	115	98	5.14	K06500152_PM0N097

**RATED  
VOLTAGE  
VDC**

**500V**

Cap $\mu\text{F}$	$\varnothing \times L$ mm	Tan $\delta$ MAX 100 Hz 20°C	ESR TYP m $\Omega$ 100 Hz 20°C	Z TYP m $\Omega$ 10 kHz 20°C	Ir a.c. A max 100 Hz 85°C	PART NUMBER termination digit excluded
68	25x30	0.15	1898	1443	0.75	K06550680_PM0C030
100	30x30	0.15	1271	970	0.95	K06550101_PM0D030
150	30x40	0.15	879	670	1.20	K06550151_PM0D040
180	30x50	0.15	722	550	1.40	K06550181_PM0D050
180	35x40	0.15	722	550	1.41	K06550181_PM0E040
220	35x40	0.15	584	445	1.55	K06550221_PM0E040
270	35x50	0.15	491	377	1.70	K06550271_PM0E050
330	35x60	0.15	400	306	2.45	K06550331_PM0E060
330	40x50	0.15	409	316	2.45	K06550331_PM0F050
470	40x60	0.15	290	223	2.62	K06550471_PM0F060
560	40x77	0.15	234	180	3.10	K06550561_PM0F077
680	40x97	0.15	192	147	3.70	K06550681_PM0F097

**RATED  
VOLTAGE  
VDC**

**550V**

Cap $\mu\text{F}$	$\varnothing \times L$ mm	Tan $\delta$ MAX 100 Hz 20°C	ESR TYP m $\Omega$ 100 Hz 20°C	Z TYP m $\Omega$ 10 kHz 20°C	Ir a.c. A max 100 Hz 85°C	PART NUMBER termination digit excluded
82	30x30	0.15	1427	1020	0.88	K06600820_PM0D030
100	30x40	0.15	1152	902	1.07	K06600101_PM0D040
150	30x50	0.15	820	630	1.32	K06600151_PM0D050
150	35x40	0.15	820	630	1.34	K06600151_PM0E040
220	35x50	0.15	574	415	1.87	K06600221_PM0E050
270	35x60	0.15	474	353	2.25	K06600271_PM0E060
270	40x50	0.15	474	353	2.25	K06600271_PM0F050
330	40x60	0.15	387	280	2.42	K06600331_PM0F060
470	40x77	0.15	277	193	2.95	K06600471_PM0F077
560	40x97	0.15	229	179	3.50	K06600561_PM0F097

**RATED  
VOLTAGE  
VDC**

**600V**

# K15 TYPE -40°C +105°C 5000H

RoHS Compliant

- High temperature 105 °C
- Surge-proof capacitor in aluminium can with insulation sleeve.
- Safety vent at bottom case or aside case.
- Snap in terminals for PCB mounting.
- 2-4 pins available (d=45mm: 4 pins only)
- Large size snap in

## APPLICATIONS

Professional switch mode power supplies. Professional power electronics.

Dimensions in mm.

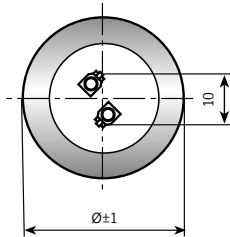
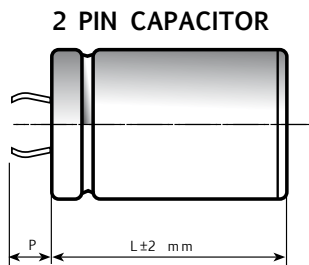

Circuit board hole dimensions

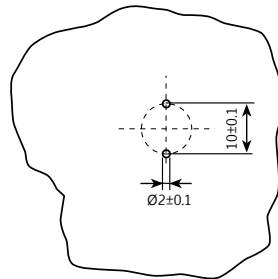

PIN LENGTH  
P 4.5 short pin  
P 6.3 long pin (standard)

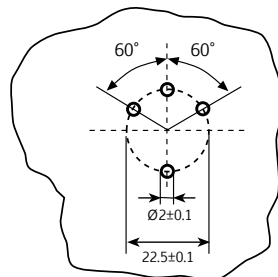
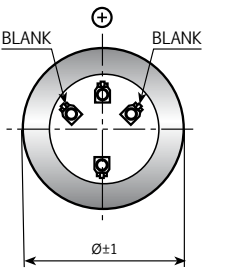
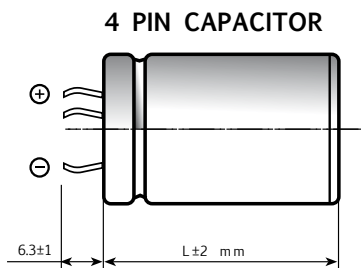
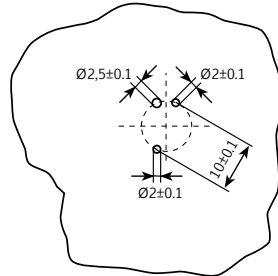
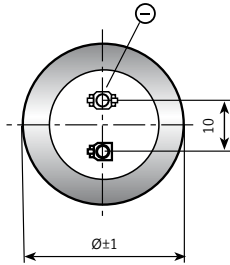
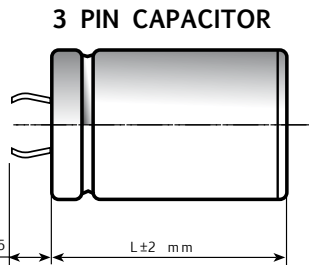

Ø	22	25	30	35	40	45	50
2 PINS	●	●	●	●	●		
3 PINS		●	●	●			
4 PINS				●	●	●	●

On demand, only for capacitors with diam ≥ 35mm: octagonal can shape for long stress vibration applications.

## SPECIFICATIONS

<b>Temperature Range</b>	Operating: -40°C +105°C Storage : Preferably below +25°C, not exceeding +40°C	
<b>Rated Voltage Range (V<sub>r</sub>)</b>	from 400V to 450V DC	
<b>Surge Voltage (V<sub>p</sub>)</b>	V <sub>p</sub> = 1.10 V <sub>r</sub>	
<b>Rated Capacitance Range</b>	from 820 µF to 2200 µF	
<b>Capacitance Tolerance</b>	±20% at 100 Hz, 20°C [M class IEC-62]	
<b>Leakage Current (I<sub>L</sub>)</b> (mA, 5 min, 20°C)	max I <sub>L</sub> = 0.003 C <sub>r</sub> V <sub>r</sub> + 4 µA	
<b>Ripple current (I<sub>r</sub>)</b>	Refer to table at 105°C and 100Hz :	
	FREQUENCY	50Hz    100Hz    500 Hz    1000Hz    >10kHz
	MULTIPLIER	0.88    1.0    1.45    1.5    1.55
	AMBIENT TEMP.	35°C    45°C    55°C    65°C    75°C    85°C    95°C    105°C
	MULTIPLIER	3.0    2.8    2.6    2.4    2.2    1.8    1.5    1.0
	Maximum internal temperature	110°C
<b>Insulation Resistance</b>	At 100V DC for 1 min is >100 MΩ across insulating sleeve and terminals.	
<b>Vibration Resistance</b>	Frequency range: 10 Hz to 55 Hz, amplitude 0.75 mm max acceleration 10 G for 3x2 h	
<b>Life test</b>	After 2,000 hours application of rated voltage at 105°C capacitors meet characteristics aside	Cap change ≤ 10% tan δ ≤ 130% Leakage current (I <sub>L</sub> ) < initial limit Impedance (Z) ≤ 130%
<b>Shelf life</b>	After leaving capacitors under no load for 500 hours at 105°C, when restored at 20°C meet specifications aside	Cap change ≤ ±15% tan δ ≤ 150% Leakage current (I <sub>L</sub> ) < initial limit
<b>Useful life</b> (V <sub>n</sub> , Temp rated I ripple applied)	> 250,000 h at 40°C > 15,000 h at 85°C > 5,000 h at 105°C	
<b>Failure percentage</b> <b>Failure rate</b>	≤ 1% (during useful life) ≤ 40 fit (40 10 <sup>-9</sup> /h)	
<b>Self inductance</b>	Approx. 20 nH	
<b>Reference standards</b>	CECC 30.301 - IEC 60384-4 LONG LIFE GRADE	

## K15 TYPE STANDARD RATINGS

Cap $\mu\text{F}$	$\varnothing \times L$ mm	Tan $\delta$ MAX 100 Hz 20°C	ESR TYP m $\Omega$ 100 Hz 20°C	Z TYP m $\Omega$ 10 kHz 20°C	Ir a.c. A max 100 Hz 105°C	PART NUMBER termination digit excluded
1200	40x77	0.10	89	80	3.58	K15400122_PM0F077
1200	45x60	0.10	89	80	3.40	K15400122_PM0N060
1500	40x97	0.10	80	71	4.76	K15400152_PM0F097
1500	45x77	0.10	85	76	4.70	K15400152_PM0N077
1500	50x60	0.10	85	76	4.2	K15400152_PM0V060
1800	45x97	0.10	69	60	5.55	K15400182_PM0N097
1800	50x77	0.10	69	60	4.9	K15400182_PM0V077
2200	45x105	0.10	59	49	6.00	K15400222_PM0N105
2700	50x105	0.10	45	35	6.2	K15400272_PM0V105

**RATED  
VOLTAGE  
VDC**

**400V**

Cap $\mu\text{F}$	$\varnothing \times L$ mm	Tan $\delta$ MAX 100 Hz 20°C	ESR TYP m $\Omega$ 100 Hz 20°C	Z TYP m $\Omega$ 10 kHz 20°C	Ir a.c. A max 100 Hz 105°C	PART NUMBER termination digit excluded
820	35x77	0.15	215	195	3.00	K15420821_PM0E077
1000	40x60	0.15	195	165	3.60	K15420102_PM0F060
1200	40x77	0.15	183	142	3.70	K15420122_PM0F077
1200	45x60	0.15	180	140	3.60	K15420122_PM0N060
1500	40x97	0.15	140	110	4.60	K15420152_PM0F097
1500	45x77	0.15	150	120	4.43	K15420152_PM0N077
1500	50x60	0.10	140	110	4.1	K15420152_PM0V060
1800	45x97	0.15	118	98	5.55	K15420182_PM0N097
1800	50x77	0.10	118	98	4.5	K15420182_PM0V077
2200	45x105	0.15	112	94	6.03	K15420222_PM0N105
2700	50x105	0.10	101	89	6.2	K15420272_PM0V105

**RATED  
VOLTAGE  
VDC**

**420V**

Cap $\mu\text{F}$	$\varnothing \times L$ mm	Tan $\delta$ MAX 100 Hz 20°C	ESR TYP m $\Omega$ 100 Hz 20°C	Z TYP m $\Omega$ 10 kHz 20°C	Ir a.c. A max 100 Hz 105°C	PART NUMBER termination digit excluded
820	40x60	0.15	216	195	3.25	K15450821_PM0F060
1000	40x77	0.15	195	165	3.76	K15450102_PM0F077
1000	45x60	0.15	195	165	3.56	K15450102_PM0N060
1200	40x97	0.15	180	140	4.54	K15450122_PM0F097
1200	45x77	0.15	184	145	4.24	K15450122_PM0N077
1200	50x60	0.10	180	145	4.0	K15450122_PM0V060
1500	45x97	0.15	140	110	5.06	K15450152_PM0N097
1500	50x77	0.10	140	110	4.9	K15450152_PM0V077
1800	45x105	0.15	126	106	5.10	K15450182_PM0N105
2200	50x105	0.10	114	95	5.9	K15450222_PM0V105

**RATED  
VOLTAGE  
VDC**

**450V**

PLEASE TO CONTACT OUR TECHNICAL SERVICE FOR MORE INFORMATION OR SPEC-IN ANALYSIS.

# K16 TYPE -40°C +85°C 5000H

RoHS Compliant

- Surge-proof capacitor in aluminium can with insulation sleeve
- Safety vent at bottom case or aside case.
- Snap in terminals for PCB mounting.
- 2-4 pins available (d=45mm: 4 pins only)
- Large size snap in

## APPLICATIONS

Professional switch mode power supplies. Professional power electronics.

Dimensions in mm.

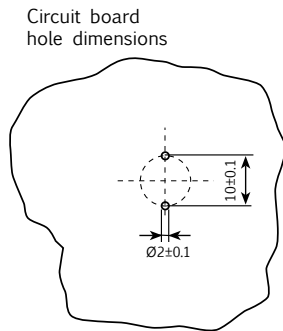
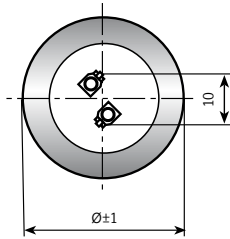
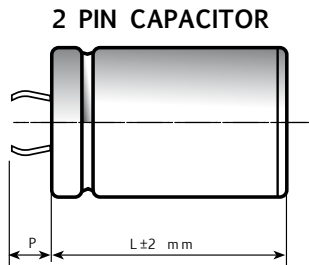

PIN LENGTH  
 P 4.5 short pin  
 P 6.3 long pin (standard)

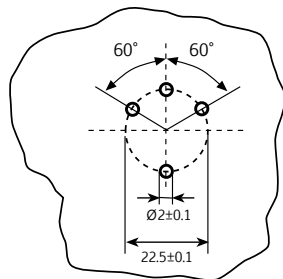
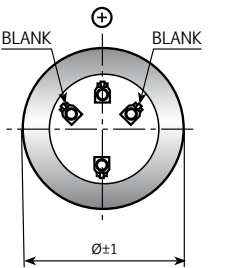
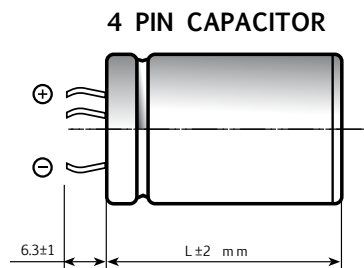
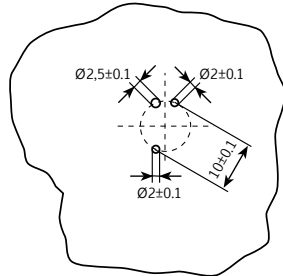
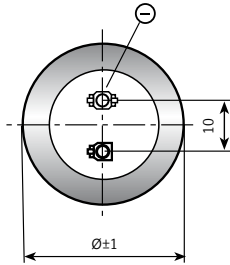
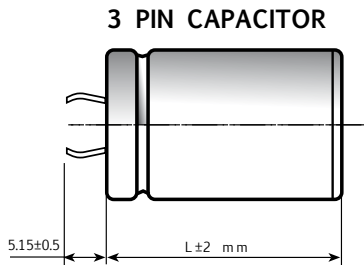

Ø	22	25	30	35	40	45	50
2 PINS	●	●	●	●	●		
3 PINS		●	●	●			
4 PINS				●	●	●	●

On demand, only for capacitors with diam ≥ 35mm: octagonal can shape for long stress vibration applications.

## SPECIFICATIONS

<b>Temperature Range</b>	Operating: -40°C +85°C Storage : Preferably below +25°C, not exceeding +40°C	
<b>Rated Voltage Range (V<sub>r</sub>)</b>	from 400V to 450V DC	
<b>Surge Voltage (V<sub>p</sub>)</b>	V <sub>p</sub> = 1.10 V <sub>r</sub>	
<b>Rated Capacitance Range</b>	from 820 µF to 2700 µF	
<b>Capacitance Tolerance</b>	±20% at 100 Hz, 20°C [M class IEC-62]	
<b>Leakage Current (I<sub>L</sub>)</b> (mA, 5 min, 20°C)	max I <sub>L</sub> = 0.006 C <sub>r</sub> V <sub>r</sub> + 4 µA At 85°C max I <sub>L</sub> = 0.04 C <sub>r</sub> V <sub>r</sub> µA	Kendeil product limit: I <sub>L</sub> = 0.003 C <sub>r</sub> V <sub>r</sub>
<b>Ripple current (I<sub>r</sub>)</b>	Refer to table at 85°C and 100Hz :	
	FREQUENCY	50Hz    100Hz    500 Hz    1000Hz    >10kHz
	MULTIPLIER	0.88    1.0    1.45    1.5    1.55
	AMBIENT TEMP.	35°C    45°C    55°C    65°C    75°C    85°C    95°C
	MULTIPLIER	2.2    2.1    1.8    1.6    1.4    1.0    0.5
	Maximum internal temperature	98°C
<b>Insulation Resistance</b>	At 100V DC for 1 min is >100 MΩ across insulating sleeve and terminals.	
<b>Vibration Resistance</b>	Frequency range: 10 Hz to 55 Hz, amplitude 0.75 mm max acceleration 10 G for 3x2 h	
<b>Life test</b>	After 2,000 hours application of rated voltage at 85°C capacitors meet characteristics aside	Cap change ≤ 10% tan δ ≤ 130% Leakage current (I <sub>L</sub> ) < initial limit Impedance (Z) ≤ 130%
<b>Shelf life</b>	After leaving capacitors under no load for 500 hours at 85°C, when restored at 20°C meet specifications aside	Cap change ≤ ±15% tan δ ≤ 150% Leakage current (I <sub>L</sub> ) < initial limit
<b>Useful life</b> (V <sub>n</sub> , Temp rated I ripple applied)	> 5,000 h at 85°C	
<b>Failure percentage</b> <b>Failure rate</b>	≤ 1% (during useful life) ≤ 33 fit (33 10 <sup>-9</sup> /h)	
<b>Self inductance</b>	Approx. 20 nH	
<b>Reference standards</b>	CECC 30.301 - IEC 60384-4 LONG LIFE GRADE	

## K16 TYPE STANDARD RATINGS

Cap $\mu\text{F}$	$\varnothing \times L$ mm	Tan $\delta$ MAX 100 Hz 20°C	ESR TYP m $\Omega$ 100 Hz 20°C	Z TYP m $\Omega$ 10 kHz 20°C	I <sub>r</sub> a.c. A max 100 Hz 85°C	PART NUMBER termination digit excluded
1000	35x77	0.10	90	80	4.50	K16400102_PM0E077
1200	40x60	0.10	89	79	4.50	K16400122_PM0F060
1500	40x77	0.10	75	64	5.80	K16400152_PM0F077
1500	45x60	0.10	80	70	4.90	K16400152_PM0N060
1800	40x97	0.10	60	50	6.60	K16400182_PM0F097
1800	45x77	0.10	70	60	6.00	K16400182_PM0N077
1800	50x60	0.10	70	60	6.30	K16400182_PM0V060
2000	40x105	0.10	45	35	7.60	K16400202_PM0F105
2200	45x97	0.10	55	45	7.30	K16400222_PM0N097
2200	50x77	0.10	55	45	7.40	K16400222_PM0V077
2700	45x105	0.10	39	27	9.00	K16400272_PM0N105
3300	50x105	0.10	37	25	10.00	K16400332_PM0V105

**RATED  
VOLTAGE  
VDC**

**400V**

Cap $\mu\text{F}$	$\varnothing \times L$ mm	Tan $\delta$ MAX 100 Hz 20°C	ESR TYP m $\Omega$ 100 Hz 20°C	Z TYP m $\Omega$ 10 kHz 20°C	I <sub>r</sub> a.c. A max 100 Hz 85°C	PART NUMBER termination digit excluded
820	35x77	0.15	220	200	3.65	K16420821_PM0E077
1000	40x60	0.15	200	170	4.90	K16420102_PM0F060
1200	40x77	0.15	190	150	4.90	K16420122_PM0F077
1200	45x60	0.15	180	140	4.90	K16420122_PM0N060
1500	40x97	0.15	140	110	5.56	K16420152_PM0F097
1500	45x77	0.15	150	120	5.36	K16420152_PM0N077
1500	50x60	0.10	150	110	4.70	K16420152_PM0V060
1800	40x105	0.15	120	100	6.40	K16420182_PM0F105
1800	50x77	0.10	120	106	5.60	K16420182_PM0V077
2200	45x97	0.15	112	102	6.70	K16420222_PM0N097
2200	50x105	0.10	112	100	7.00	K16420222_PM0V105
2700	50x105	0.10	101	102	7.40	K16420272_PM0V105

**RATED  
VOLTAGE  
VDC**

**420V**

Cap $\mu\text{F}$	$\varnothing \times L$ mm	Tan $\delta$ MAX 100 Hz 20°C	ESR TYP m $\Omega$ 100 Hz 20°C	Z TYP m $\Omega$ 10 kHz 20°C	I <sub>r</sub> a.c. A max 100 Hz 85°C	PART NUMBER termination digit excluded
820	35x77	0.15	215	195	3.65	K16450821_PM0E077
1000	40x60	0.15	195	165	4.90	K16450102_PM0F060
1200	40x77	0.15	183	142	4.90	K16450122_PM0F077
1200	45x60	0.15	180	140	4.90	K16450122_PM0N060
1500	40x97	0.15	140	110	5.56	K16450152_PM0F097
1500	45x77	0.15	150	120	5.36	K16450152_PM0N077
1500	50x60	0.10	140	110	4.7	K16450152_PM0V060
1800	45x97	0.15	128	110	6.50	K16450182_PM0N097
1800	50x77	0.10	128	108	5.6	K16450182_PM0V077
2200	45x105	0.15	112	102	6.80	K16450222_PM0N105
2700	50x105	0.10	112	102	7.4	K16450272_PM0V105

**RATED  
VOLTAGE  
VDC**

**450V**

# K25 TYPE -40°C +105C 8000H

RoHS Compliant

- Surge-proof capacitor in aluminium can with insulation sleeve
- Snap in terminals for PCB mounting.
- Design optimized for high ripple current applications

## APPLICATIONS

Designed for professional application. Ultra compact UPS, Solar inverters, High ripple current converters, Motor drives.

Dimensions in mm.

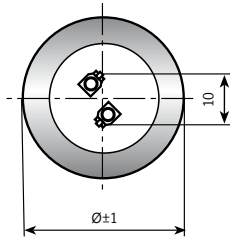
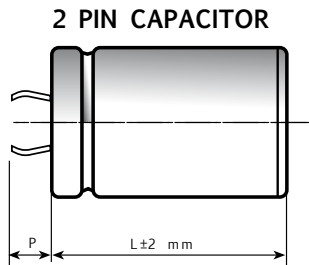

Circuit board hole dimensions

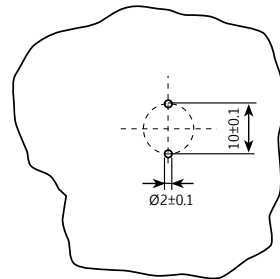

PIN LENGTH  
P 4.5 short pin  
P 6.3 long pin (standard)

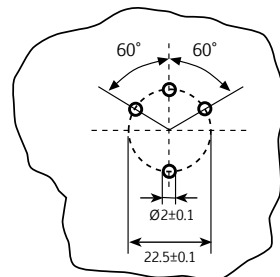
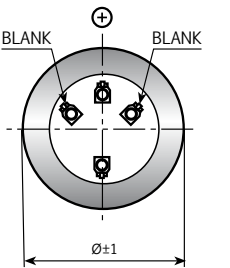
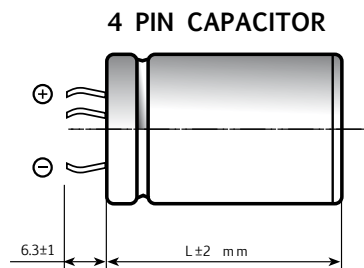
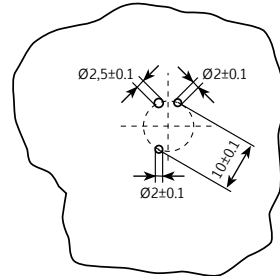
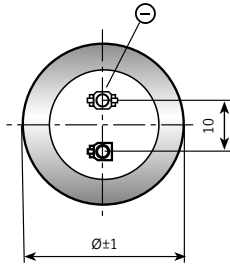
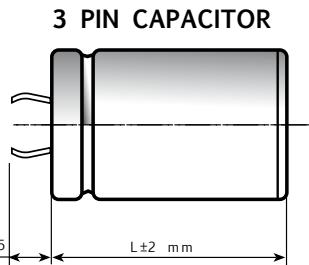

Ø	22	25	30	35	40	45	50
2 PINS	●	●	●	●	●		
3 PINS		●	●	●			
4 PINS				●	●	●	●

On demand, only for capacitors with diam ≥ 35mm: octagonal can shape for long stress vibration applications.



## SPECIFICATIONS

<b>Temperature Range</b>	Operating: -40°C +105°C Storage : Preferably below +25°C, not exceeding +40°C	[Environmental classification 40/85/56 IEC-68]
<b>Rated Voltage Range (V<sub>r</sub>)</b>	from 400V to 450V DC	
<b>Surge Voltage (V<sub>p</sub>)</b>	V <sub>p</sub> = 1.10 V <sub>r</sub>	
<b>Rated Capacitance Range</b>	from 820 µF to 2200 µF	
<b>Capacitance Tolerance</b>	±20% at 100 Hz, 20°C [M class IEC-62]	
<b>Leakage Current (I<sub>L</sub>)</b> (mA, 5 min, 20°C)	max I <sub>L</sub> = 0.003 C <sub>r</sub> V <sub>r</sub> + 4 µA	
<b>Ripple current (I<sub>r</sub>)</b>	Refer to table at 105°C and 100Hz:	
	FREQUENCY MULTIPLIER	50Hz 100Hz 500 Hz 1000Hz >10kHz 0.88 1.0 1.45 1.50 1.55
	AMBIENT TEMP. MULTIPLIER	35°C 45°C 55°C 65°C 75°C 85°C 95°C 105°C 110°C 3.0 2.8 2.6 2.4 2.2 1.8 1.5 1.0 0.5
	Maximum internal temperature 110°C	
<b>Insulation Resistance</b>	At 100V DC for 1 min is >100 MΩ across insulating sleeve and terminals.	
<b>Vibration Resistance</b>	Frequency range: 10 Hz to 55 Hz, amplitude 0.75 mm max acceleration 10g for 3x2 h	
<b>Life test</b>	After 2,000 hours application of rated voltage at 105°C capacitors meet characteristics aside	Cap change ≤ 10% tan δ ≤ 130% Leakage current (I <sub>L</sub> ) < initial limit Impedance (Z) ≤ 130%
<b>Shelf life</b>	After leaving capacitors under no load for 500 hours at 105° C when restored at 20°C meet specifications aside	Cap change ≤ ±15% tan δ ≤ 150% Leakage current (I <sub>L</sub> ) < initial limit
<b>Useful life</b> (V <sub>n</sub> , Temp rated I ripple applied)	> 250000 h at 40°C > 8000 h at 105°C	
<b>Failure percentage</b> <b>Failure rate</b>	≤ 1% (during useful life) ≤ 40 fit (40 10 <sup>-9</sup> /h)	
<b>Self inductance</b>	Approx. 20 nH	
<b>Reference standards</b>	CECC 30.300 - IEC 60384-4 LONG LIFE GRADE	

## K25 TYPE STANDARD RATINGS

Cap $\mu\text{F}$	$\varnothing \times L$ mm	Tan $\delta$ MAX 100 Hz 20°C	ESR TYP m $\Omega$ 100 Hz 20°C	Z TYP m $\Omega$ 10 kHz 20°C	I <sub>r</sub> a.c. A max 100 Hz 105°C	PART NUMBER termination digit excluded
1200	40x77	0.10	89	64	3.6	K25400122_PM0F077
1200	45x60	0.10	89	64	3.6	K25400122_PM0N060
1500	40x97	0.10	75	55	4.8	K25400152_PM0F097
1500	45x77	0.10	75	55	4.7	K25400152_PM0N077
1500	50x60	0.10	75	55	4.4	K25400152_PM0V060
1800	45x97	0.10	69	60	5.6	K25400182_PM0N097
1800	50x77	0.10	69	60	5.5	K25400182_PM0V077
2200	45x105	0.10	47	40	6.1	K25400222_PM0N105
2700	50x105	0.10	37	30	6.5	K25400272_PM0V105

**RATED  
VOLTAGE  
VDC**

**400V**

Cap $\mu\text{F}$	$\varnothing \times L$ mm	Tan $\delta$ MAX 100 Hz 20°C	ESR TYP m $\Omega$ 100 Hz 20°C	Z TYP m $\Omega$ 10 kHz 20°C	I <sub>r</sub> a.c. A max 100 Hz 105°C	PART NUMBER termination digit excluded
820	35x77	0.10	104	85	3.0	K25420821_PM0E077
1000	40x60	0.10	99	74	3.6	K25420102_PM0F060
1200	40x77	0.10	94	64	3.7	K25420122_PM0F077
1200	45x60	0.10	94	64	3.6	K25420122_PM0N060
1500	40x97	0.10	75	55	4.6	K25420152_PM0F097
1500	45x77	0.11	75	55	4.5	K25420152_PM0N077
1500	50x60	0.10	75	55	4.4	K25420152_PM0V060
1800	45x97	0.11	69	51	5.6	K25420182_PM0N097
1800	50x77	0.10	69	51	5.5	K25420182_PM0V077
2200	45x105	0.12	47	40	6.1	K25420222_PM0N105
2700	50x105	0.10	37	30	6.5	K25420272_PM0V105

**RATED  
VOLTAGE  
VDC**

**420V**

Cap $\mu\text{F}$	$\varnothing \times L$ mm	Tan $\delta$ MAX 100 Hz 20°C	ESR TYP m $\Omega$ 100 Hz 20°C	Z TYP m $\Omega$ 10 kHz 20°C	I <sub>r</sub> a.c. A max 100 Hz 105°C	PART NUMBER termination digit excluded
820	40x60	0.10	104	85	3.3	K25450821_PM0F060
1000	40x77	0.10	99	74	3.8	K25450102_PM0F077
1000	45x60	0.10	99	74	3.6	K25450102_PM0N060
1200	40x97	0.10	94	64	4.6	K25450122_PM0F097
1200	45x77	0.10	94	64	4.3	K25450122_PM0N077
1200	50x60	0.10	94	64	4.2	K25450122_PM0V060
1500	45x97	0.11	75	55	5.1	K25450152_PM0N097
1500	50x77	0.10	75	55	5.3	K25450152_PM0V077
1800	45x105	0.11	69	51	5.1	K25450182_PM0N105
2200	50x105	0.10	47	40	6.2	K25450222_PM0V105

**RATED  
VOLTAGE  
VDC**

**450V**

# K26 TYPE -40°C +85°C 12000H

RoHS Compliant

- Surge-proof capacitor in aluminium can with insulation sleeve
- Snap in terminals for PCB mounting.
- Design optimized for high ripple current applications

## APPLICATIONS

Designed for professional application. Ultra compact UPS, Solar inverters, High ripple current converters, Motor drives.

Dimensions in mm.

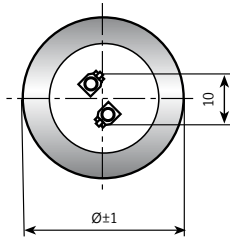
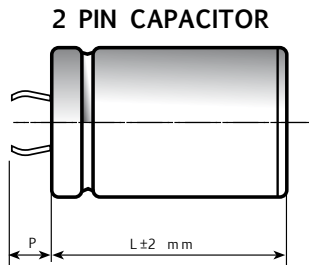

Circuit board hole dimensions

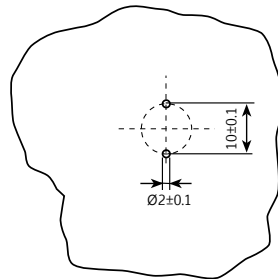

PIN LENGTH  
P 4.5 short pin  
P 6.3 long pin (standard)

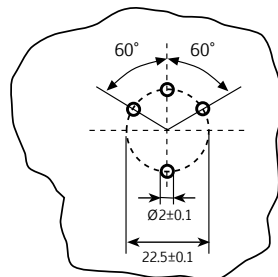
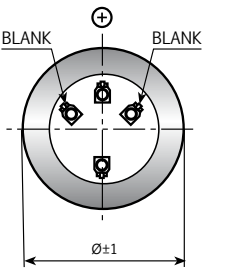
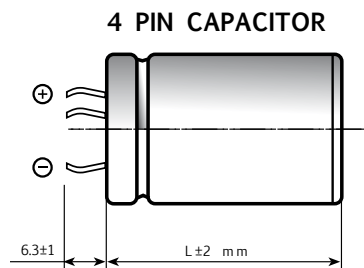
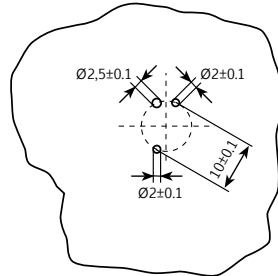
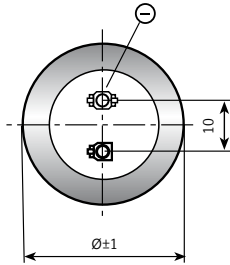
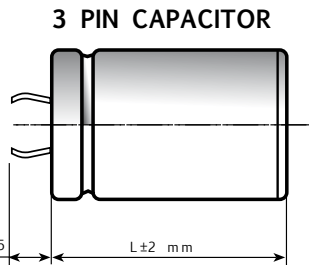

Ø	22	25	30	35	40	45	50
2 PINS	●	●	●	●	●		
3 PINS		●	●	●			
4 PINS				●	●	●	●

On demand, only for capacitors with diam ≥ 35mm: octagonal can shape for long stress vibration applications.

## SPECIFICATIONS

<b>Temperature Range</b>	Operating: -40°C +85°C Storage : Preferably below +25°C, not exceeding +40°C	[Environmental classification 40/85/56 IEC-68]
<b>Rated Voltage Range (V<sub>r</sub>)</b>	from 400V to 450V DC	
<b>Surge Voltage (V<sub>p</sub>)</b>	V <sub>p</sub> = 1.10 V <sub>r</sub>	
<b>Rated Capacitance Range</b>	from 1000 µF to 2700 µF	
<b>Capacitance Tolerance</b>	±20% at 100 Hz, 20°C [M class IEC-62] on request: -10% +30% at 100 Hz, 20°C [Q class IEC-62]	
<b>Leakage Current (I<sub>L</sub>) (mA, 5 min, 20°C)</b>	max I <sub>L</sub> = 0.006 C <sub>r</sub> V <sub>r</sub> + 4 µA At 85°C max I <sub>L</sub> = 0.04 C <sub>r</sub> V <sub>r</sub> µA	Kendeil product limit: I <sub>L</sub> = 0.003 C <sub>r</sub> V <sub>r</sub>
<b>Ripple current (I<sub>r</sub>)</b>	Refer to table at 85°C and 100Hz:	
	FREQUENCY	50Hz    100Hz    500 Hz    1000Hz    >10kHz
	MULTIPLIER	0.88    1.0    1.45    1.50    1.55
	AMBIENT TEMP.	35°C    45°C    55°C    65°C    75°C    85°C    95°C
	MULTIPLIER	2.2    2.1    1.8    1.6    1.4    1.0    0.5
	Maximum internal temperature	98°C
<b>Insulation Resistance</b>	At 100V DC for 1 min is >100 MΩ across insulating sleeve and terminals.	
<b>Vibration Resistance</b>	Frequency range: 10 Hz to 500 Hz, amplitude 0.75 mm max acceleration 10g for 3x2 h	
<b>Life test</b>	After 2,000 hours application of rated voltage at 85°C capacitors meet characteristics aside	Cap change ≤ 10% tan δ ≤ 130% Leakage current (I <sub>L</sub> ) < initial limit Impedance (Z) ≤ 200%
<b>Shelf life</b>	After leaving capacitors under no load for 500 hours at 85°C, when restored at 20°C meet specifications aside	Cap change ≤ ±15% tan δ ≤ 150% Leakage current (I <sub>L</sub> ) < initial limit
<b>Useful life (V<sub>n</sub>, Temp rated I ripple applied)</b>	> 200000 h at 40°C > 12000 h at 85°C	
<b>Failure percentage Failure rate</b>	≤ 1% (during useful life) ≤ 33 fit (33 10 <sup>-9</sup> /h)	
<b>Self inductance</b>	Approx. 20 nH	
<b>Reference standards</b>	CECC 30.300 - IEC 60384-4 LONG LIFE GRADE	

## K26 TYPE STANDARD RATINGS

Cap $\mu\text{F}$	$\varnothing \times L$ mm	Tan $\delta$ MAX 100 Hz 20°C	ESR TYP m $\Omega$ 100 Hz 20°C	Z TYP m $\Omega$ 10 kHz 20°C	I <sub>r</sub> a.c. A max 100 Hz 85°C	PART NUMBER termination digit excluded
1000	40x60	0.12	99	74	5.1	K26400102_PM0F060
1200	40x77	0.12	94	64	5.2	K26400122_PM0F077
1500	45x60	0.12	84	61	5.4	K26400152_PM0N060
1800	45x77	0.12	70	51	6.2	K26400182_PM0N077
1800	50x60	0.10	70	51	6.5	K26400182_PM0V060
2000	40x105	0.12	61	44	7.6	K26400202_PM0F105
2200	45x105	0.13	47	40	7.8	K26400222_PM0N105
2200	50x77	0.10	47	40	7.6	K26400222_PM0V077
2700	45x105	0.13	46	39	9.2	K26400272_PM0N105
3300	50x105	0.10	37	30	10.2	K26400332_PM0V105

**RATED  
VOLTAGE  
VDC**

**400V**

Cap $\mu\text{F}$	$\varnothing \times L$ mm	Tan $\delta$ MAX 100 Hz 20°C	ESR TYP m $\Omega$ 100 Hz 20°C	Z TYP m $\Omega$ 10 kHz 20°C	I <sub>r</sub> a.c. A max 100 Hz 85°C	PART NUMBER termination digit excluded
1000	40x60	0.11	99	74	5.1	K26420102_PM0F060
1200	40x77	0.11	94	64	5.2	K26420122_PM0F077
1200	45x60	0.11	94	64	5.2	K26420122_PM0N060
1500	40x105	0.12	75	55	6.3	K26420152_PM0F105
1500	45x77	0.12	75	55	5.6	K26420152_PM0N077
1500	50x60	0.10	75	55	5.7	K26420152_PM0V060
1800	50x77	0.10	67	50	6.9	K26420182_PM0V077
2200	45x105	0.13	47	40	7.8	K26420222_PM0N105
2700	50x105	0.10	37	30	9.5	K26420272_PM0V105

**RATED  
VOLTAGE  
VDC**

**420V**

Cap $\mu\text{F}$	$\varnothing \times L$ mm	Tan $\delta$ MAX 100 Hz 20°C	ESR TYP m $\Omega$ 100 Hz 20°C	Z TYP m $\Omega$ 10 kHz 20°C	I <sub>r</sub> a.c. A max 100 Hz 85°C	PART NUMBER termination digit excluded
1000	40x60	0.11	99	74	5.1	K26450102_PM0F060
1200	40x77	0.11	94	64	5.2	K26450122_PM0F077
1200	45x60	0.11	94	64	5.2	K26450122_PM0N060
1500	40x105	0.12	75	55	6.3	K26450152_PM0F105
1500	45x77	0.12	75	55	5.6	K26450152_PM0N077
1500	50x60	0.10	75	55	5.7	K26450152_PM0V060
1800	50x77	0.10	67	50	6.9	K26450182_PM0V077
2200	45x105	0.13	47	40	7.8	K26450222_PM0N105
2700	50x105	0.10	37	30	9.5	K26450272_PM0V105

**RATED  
VOLTAGE  
VDC**

**450V**

PLEASE TO CONTACT OUR TECHNICAL SERVICE FOR MORE INFORMATION OR SPEC-IN ANALYSIS.

# K55 TYPE -40°C +105°C 6000H

RoHS Compliant

- Design optimized for Solar inverter
- Very high CV for unit volume
- Low ESR, High ripple current and long file
- Safety vent at bottom case or aside case

## APPLICATIONS

Designed for Solar inverters and professional power supplies.

Dimensions in mm.

### 2 PIN CAPACITOR

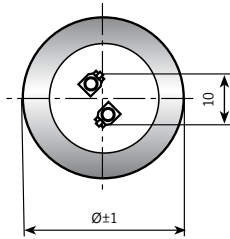
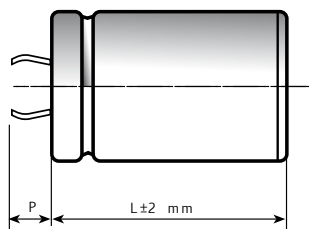

Circuit board hole dimensions

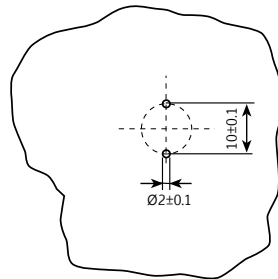

PIN LENGTH  
P 4.5 short pin  
P 6.3 long pin (standard)

### 3 PIN CAPACITOR

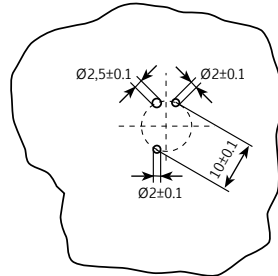
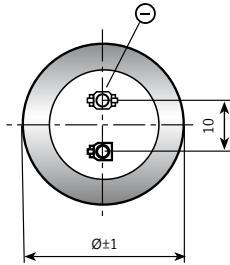
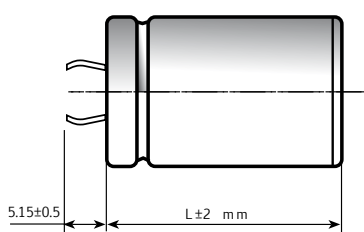

### 4 PIN CAPACITOR

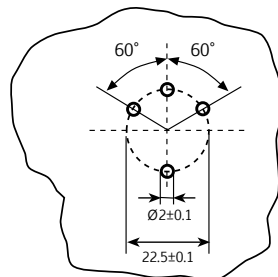
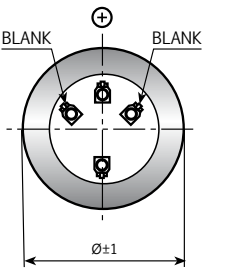
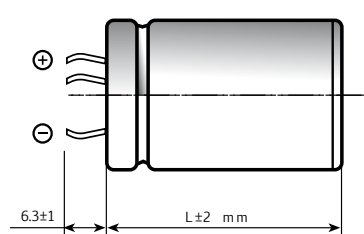

Ø	22	25	30	35	40	45	50
2 PINS	●	●	●	●	●		
3 PINS		●	●	●			
4 PINS				●	●	●	●

On demand, only for capacitors with diam ≥ 35mm: octagonal can shape for long stress vibration applications.

## SPECIFICATIONS

<b>Temperature Range</b>	Operating: -40°C +105°C Storage : Preferably below +25°C, not exceeding +40°C	
<b>Rated Voltage Range (V<sub>r</sub>)</b>	450V DC at 105°C, 500V DC at 50°C	
<b>Surge Voltage (V<sub>p</sub>)</b>	500V	
<b>Rated Capacitance Range</b>	from 330 µF to 820 µF	
<b>Capacitance Tolerance</b>	±20% at 100 Hz, 20°C [M class IEC-62]	
<b>Leakage Current (I<sub>L</sub>)</b> (mA, 5 min, 20°C)	max I <sub>L</sub> = 0.003 C <sub>r</sub> V <sub>r</sub> + 4 µA	
<b>Ripple current (I<sub>r</sub>)</b>	Refer to table at 105°C and 100Hz:	
	FREQUENCY	50Hz 100Hz 500 Hz 1000Hz >10kHz
	MULTIPLIER	0.88 1.0 1.45 1.5 1.55
	AMBIENT TEMP.	35°C 45°C 55°C 65°C 75°C 85°C 95°C 105°C
	MULTIPLIER	3.0 2.8 2.6 2.4 2.2 1.8 1.5 1
	Maximum internal temperature 110°C	
<b>Insulation Resistance</b>	At 100V DC for 1 min is >100 MΩ across insulating sleeve and terminals.	
<b>Vibration Resistance</b>	Frequency range: 10 Hz to 55 Hz, amplitude 0.75 mm max acceleration 10g for 3x2 h	
<b>Life test</b>	After 2,000 hours application of rated voltage at 105°C capacitors meet characteristics aside	Cap change ≤ ±20% tan δ ≤ 200% Leakage current (I <sub>L</sub> ) < initial limit Impedance (Z) ≤ 200%
<b>Shelf life</b>	After leaving capacitors under no load for 500 hours at 105°C, when restored at 20°C meet specifications aside	Cap change ≤ ±15% tan δ ≤ 150% Leakage current (I <sub>L</sub> ) < initial limit
<b>Useful life</b> (V <sub>n</sub> , Temp rated I ripple applied)	250,000 h at 40°C - 450V with ripple current applied 6,000 h at 105°C - 450V with ripple current applied 5,000 h at 50°C - 500V without ripple current applied	
<b>Failure percentage</b> <b>Failure rate</b>	≤ 1% (during useful life) ≤ 40 fit (40 10 <sup>-9</sup> /h)	
<b>Self inductance</b>	Approx. 15 nH	
<b>Reference standards</b>	CECC 30.300 - IEC 60384-4 LONG LIFE GRADE	

## K55 TYPE STANDARD RATINGS

Cap $\mu\text{F}$	$\varnothing \times L$ mm	Tan $\delta$ MAX 100 Hz 20°C	ESR TYP m $\Omega$ 100 Hz 20°C	Z TYP m $\Omega$ 10 kHz 20°C	Ir a.c. A max 100 Hz 105°C	PART NUMBER termination digit excluded
330	30x40	0.09	240	170	1.80	K55450331_PM0D040
330	35x40	0.09	240	170	2.10	K55450331_PM0E040
390	30x50	0.09	197	149	2.20	K55450391_PM0D050
470	30x50	0.09	195	147	2.25	K55450471_PM0D050
470	35x50	0.09	195	147	2.67	K55450471_PM0E050
560	35x50	0.09	150	103	2.80	K55450561_PM0E050
560	35x60	0.09	150	103	3.10	K55450561_PM0E060
680	35x50	0.09	149	115	2.85	K55450681_PM0E050
680	35x60	0.09	149	115	3.25	K55450681_PM0E060
820	40x60	0.09	120	92	3.60	K55450821_PM0F060

**RATED  
VOLTAGE  
VDC**

**450V**

PLEASE TO CONTACT OUR TECHNICAL SERVICE FOR MORE INFORMATION OR SPEC-IN ANALYSIS.



# K75 TYPE -40°C +105°C 5000H

RoHS Compliant

- Design optimized for extremely high miniaturization.
- Surge-proof capacitor in aluminium can with insulation sleeve.
- Snap in terminals for PCB mounting.

## APPLICATIONS

Designed for professional application.  
Ultra compact UPS, Solar inverters, High ripple current converters, Motor drives.

Dimensions in mm.

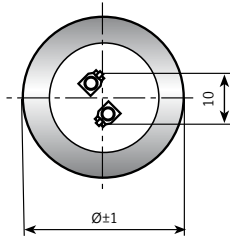
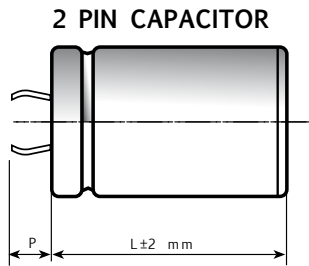

Circuit board hole dimensions

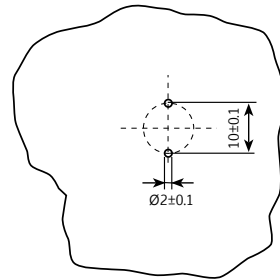

PIN LENGTH  
P 4.5 short pin  
P 6.3 long pin (standard)

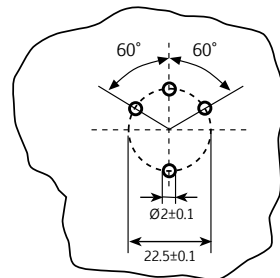
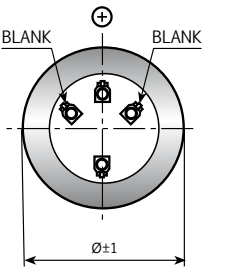
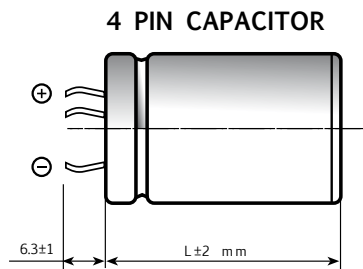
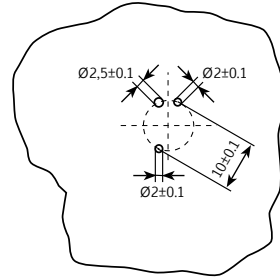
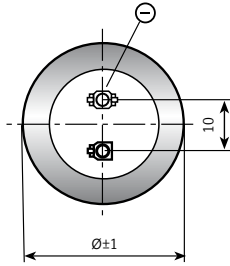
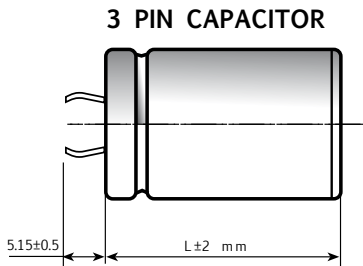

Ø	22	25	30	35	40	45	50
2 PINS	●	●	●	●	●		
3 PINS		●	●	●			
4 PINS				●	●	●	●

On demand, only for capacitors with diam ≥ 35mm: octagonal can shape for long stress vibration applications.

## SPECIFICATIONS

<b>Temperature Range</b>	Operating : -40°C +105°C Storage : Preferably below +25°C, not exceeding +40°C	
<b>Rated Voltage Range (V<sub>r</sub>)</b>	from 200V to 450V DC	
<b>Surge Voltage (V<sub>p</sub>)</b>	V <sub>p</sub> = 1.10 V <sub>r</sub>	
<b>Rated Capacitance Range</b>	from 220 µF to 5600 µF	
<b>Capacitance Tolerance</b>	±20% at 100 Hz, 20°C [M class IEC-62]	
<b>Leakage Current (I<sub>L</sub>) (mA, 5 min, 20°C)</b>	max I <sub>L</sub> = 0.006 C <sub>r</sub> V <sub>r</sub> + 4 µA	
<b>Ripple current (I<sub>r</sub>)</b>	Refer to table at 105°C and 100Hz :	
	FREQUENCY	50Hz    100Hz    500Hz    1000Hz    >10kHz
	MULTIPLIER	0.88    1.0    1.45    1.5    1.55
	AMBIENT TEMP	35°C    45°C    55°C    65°C    75°C    85°C    95°C    105°C
	MULTIPLIER	3.0    2.8    2.6    2.4    2.2    1.8    1.5    1
<b>Insulation Resistance</b>	At 100V DC for 1 min is >100 MΩ across insulating sleeve and terminals.	
<b>Vibration Resistance</b>	Frequency range : 10 Hz to 55 Hz, amplitude 0.75 mm max acceleration 10g for 3x2 h	
<b>Life test (105°C, V<sub>n</sub>, I<sub>r</sub> applied)</b>	After 2,000 hours application of rated voltage at 105°C capacitors meet characteristics aside	Cap change ≤ 10% tan δ ≤ 130% Leakage current (I <sub>L</sub> ) < initial limit Impedance (Z) ≤ 130%
<b>Shelf life</b>	After leaving capacitors under no load for 500 hours at 105°C, when restored at 20°C meet specifications aside	Cap change ≤ ±15% tan δ ≤ 150% Leakage current (I <sub>L</sub> ) < initial limit
<b>Useful life (105°C, V<sub>n</sub>, I<sub>r</sub> applied)</b>	≥ 5.000 h at 105°C	Cap change ≤ 20% tan δ ≤ 200% Leakage current (I <sub>L</sub> ) < initial limit Impedance (Z) ≤ 200%
<b>Failure percentage Failure rate</b>	≤ 1% (during useful life) ≤ 40 fit (40 10 <sup>-9</sup> /h)	
<b>Self inductance</b>	Approx. 15 nH	
<b>Reference standards</b>	CECC 30.300 IEC 60384-4 LONG LIFE GRADE	

## K75 TYPE STANDARD RATINGS

Cap µF	Ø x L mm	Tan δ MAX 100 Hz 20°C	ESR TYP mΩ 100 Hz 20°C	Z TYP mΩ 10 kHz 20°C	Ir a.c. A max 100 Hz 105°C	PART NUMBER termination digit excluded
560	25x30	0.09	106	39	1.90	K75200561_PM0C030
680	25x35	0.09	85	32	2.25	K75200681_PM0C035
820	25x40	0.09	67	25	2.52	K75200821_PM0C040
820	30x30	0.09	84	34	2.40	K75200821_PM0D030
1000	25x45	0.10	61	23	2.93	K75200102_PM0C045
1000	30x35	0.10	68	30	2.83	K75200102_PM0D035
1000	35x30	0.10	75	37	2.75	K75200102_PM0E030
1200	25x50	0.10	53	22	3.27	K75200122_PM0C050
1200	30x40	0.10	58	25	3.19	K75200122_PM0D040
1200	35x30	0.10	69	33	2.86	K75200122_PM0E030
1500	30x45	0.10	50	22	3.64	K75200152_PM0D045
1500	35x35	0.10	58	26	3.24	K75200152_PM0E035
1800	35x40	0.10	53	27	3.70	K75200182_PM0E040
2200	35x45	0.10	46	24	4.17	K75200222_PM0E045
2200	35x50	0.10	46	24	4.61	K75200222_PM0E050
2700	35x60	0.10	33	17	5.51	K75200272_PM0E060
3300	40x60	0.10	32	18	6.00	K75200332_PM0F060

**RATED  
VOLTAGE  
VDC**

**200V**

Cap µF	Ø x L mm	Tan δ MAX 100 Hz 20°C	ESR TYP mΩ 100 Hz 20°C	Z TYP mΩ 10 kHz 20°C	Ir a.c. A max 100 Hz 105°C	PART NUMBER termination digit excluded
390	25x30	0.09	141	52	1.65	K75250391_PM0C030
470	25x35	0.09	111	42	1.96	K75250471_PM0C035
560	30x30	0.09	106	44	2.14	K75250561_PM0D030
680	25x45	0.09	80	33	2.54	K75250681_PM0C045
760	30x35	0.09	82	35	2.51	K75250761_PM0D035
820	30x40	0.09	75	30	2.84	K75250821_PM0D040
820	35x30	0.09	84	36	2.53	K75250821_PM0E030
1000	30x45	0.10	60	26	3.30	K75250102_PM0D045
1000	35x35	0.10	66	32	3.04	K75250102_PM0E035
1200	30x50	0.10	55	22	3.60	K75250122_PM0D050
1200	35x40	0.10	55	22	3.50	K75250122_PM0E040
1500	35x50	0.10	48	22	4.22	K75250152_PM0E050
2200	35x60	0.10	39	18	5.03	K75250222_PM0E060
2500	40x60	0.10	31	18	5.98	K75250252_PM0F060

**RATED  
VOLTAGE  
VDC**

**250V**

## K75 TYPE STANDARD RATINGS

Cap µF	Ø x L mm	Tan δ MAX 100 Hz 20°C	ESR TYP mΩ 100 Hz 20°C	Z TYP mΩ 10 kHz 20°C	Ir a.c. A max 100 Hz 105°C	PART NUMBER termination digit excluded
330	25x35	0.09	238	117	1.34	K75350331_PM0C035
370	25x35	0.09	238	115	1.34	K75350371_PM0C035
390	30x30	0.09	225	114	1.47	K75350391_PM0D030
470	30x30	0.09	208	107	1.53	K75350471_PM0D030
560	30x35	0.09	169	87	1.79	K75350561_PM0D035
620	30x40	0.09	149	76	2.00	K75350621_PM0D040
620	35x30	0.09	161	86	2.00	K75350621_PM0E030
680	30x45	0.09	127	66	2.26	K75350681_PM0D045
680	35x35	0.09	142	79	2.16	K75350681_PM0E035
780	30x45	0.09	123	63	2.30	K75350781_PM0D045
780	35x35	0.09	139	77	2.19	K75350781_PM0E035
820	30x50	0.09	111	57	2.51	K75350821_PM0D050
900	35x40	0.09	118	65	2.48	K75350901_PM0E040
1000	35x45	0.10	102	56	2.78	K75350102_PM0E045
1200	35x50	0.10	88	49	3.12	K75350122_PM0E050
1500	35x60	0.10	72	40	3.71	K75350152_PM0E060
2000	40x60	0.10	68	38	4.29	K75350202_PM0F060
2200	45x60	0.10	48	26	4.80	K75350222_PM0N060
2700	45x77	0.10	39	22	6.22	K75350272_PM0N077
2700	50x60	0.10	43	26	5.40	K75350272_PM0V060
2900	40x97	0.10	42	25	6.22	K75350292_PM0F097
3300	50x77	0.10	36	22	6.00	K75350332_PM0V077
3700	45x105	0.10	27	15	7.60	K75350372_PM0N105
4700	50x105	0.10	25	15	8.30	K75350472_PM0V105

**RATED  
VOLTAGE  
VDC**

**350V**

Cap µF	Ø x L mm	Tan δ MAX 100 Hz 20°C	ESR TYP mΩ 100 Hz 20°C	Z TYP mΩ 10 kHz 20°C	Ir a.c. A max 100 Hz 105°C	PART NUMBER termination digit excluded
220	25x35	0.09	328	148	1.15	K75400221_PM0C035
270	25x35	0.09	270	125	1.26	K75400271_PM0C035
330	25x40	0.09	240	110	1.39	K75400331_PM0C040
330	30x30	0.09	240	110	1.43	K75400331_PM0D030
370	30x30	0.09	238	108	1.44	K75400371_PM0D030
470	30x35	0.09	190	91	1.69	K75400471_PM0D035
470	30x40	0.09	168	81	1.88	K75400471_PM0D040
510	30x40	0.09	166	80	1.89	K75400511_PM0D040
510	35x30	0.09	189	89	1.78	K75400511_PM0E030
560	30x45	0.09	140	68	2.15	K75400561_PM0D045
560	35x35	0.09	156	81	2.06	K75400561_PM0E035
630	30x45	0.09	139	66	2.17	K75400631_PM0D045
630	35x35	0.09	154	80	2.07	K75400631_PM0E035
680	30x50	0.09	126	60	2.37	K75400681_PM0D050
680	35x40	0.09	132	68	2.35	K75400681_PM0E040
820	30x60	0.09	102	49	2.82	K75400821_PM0D060
820	35x45	0.09	114	59	2.64	K75400821_PM0E045
1000	35x50	0.10	97	51	2.96	K75400102_PM0E050
1200	35x60	0.10	79	41	3.54	K75400122_PM0E060
1500	40x60	0.10	68	39	4.10	K75400152_PM0F060
1800	45x60	0.10	53	27	5.03	K75400182_PM0N060
2000	45x77	0.10	44	23	5.10	K75400202_PM0N077
2200	40x97	0.10	46	26	5.10	K75400222_PM0F097
2200	50x60	0.10	48	27	4.80	K75400222_PM0V060
2700	50x77	0.10	39	22	5.70	K75400272_PM0V077
2900	45x105	0.10	31	16	7.90	K75400292_PM0N105
3900	50x105	0.10	27	16	8.20	K75400392_PM0V105

**RATED  
VOLTAGE  
VDC**

**400V**

## K75 TYPE STANDARD RATINGS

Cap µF	Ø x L mm	Tan δ MAX 100 Hz 20°C	ESR TYP mΩ 100 Hz 20°C	Z TYP mΩ 10 kHz 20°C	I <sub>r</sub> a.c. A max 100 Hz 105°C	PART NUMBER termination digit excluded
220	25x35	0.09	329	144	1.14	K75420221_PM0C035
250	25x35	0.09	292	129	1.21	K75420251_PM0C035
330	30x30	0.09	256	118	1.38	K75420331_PM0D030
390	30x35	0.09	206	96	1.62	K75420391_PM0D035
470	30x40	0.09	178	81	1.83	K75420471_PM0D040
470	35x30	0.09	198	98	1.73	K75420471_PM0E030
560	30x45	0.09	149	69	2.09	K75420561_PM0D045
560	35x35	0.09	165	82	2.01	K75420561_PM0E035
620	30x50	0.09	135	62	2.28	K75420621_PM0D060
650	35x40	0.09	140	66	2.28	K75420651_PM0E040
680	35x45	0.09	121	60	2.55	K75420681_PM0E045
820	35x50	0.09	105	53	2.85	K75420821_PM0E050
1000	35x60	0.10	84	44	3.41	K75420102_PM0E060
1300	40x60	0.10	73	40	4.00	K75420132_PM0F060
1500	45x60	0.10	56	28	4.50	K75420152_PM0N060
1800	45x77	0.10	47	24	5.30	K75420182_PM0N077
2000	40x97	0.10	48	26	5.50	K75420202_PM0F097
2000	50x60	0.10	50	27	4.80	K75420202_PM0V060
2400	50x77	0.10	42	23	5.70	K75420242_PM0V077
2700	45x105	0.10	32	16	7.05	K75420272_PM0N105
3500	50x105	0.10	28	16	7.90	K75420352_PM0V105

**RATED  
VOLTAGE  
VDC**

**420V**

Cap µF	Ø x L mm	Tan δ MAX 100 Hz 20°C	ESR TYP mΩ 100 Hz 20°C	Z TYP mΩ 10 kHz 20°C	I <sub>r</sub> a.c. A max 100 Hz 105°C	PART NUMBER termination digit excluded
220	25x35	0.09	325	145	1.10	K75450221_PM0C035
270	30x30	0.09	283	132	1.28	K75450271_PM0D030
330	30x35	0.09	228	107	1.50	K75450331_PM0D035
390	30x40	0.09	200	92	1.70	K75450391_PM0D040
470	30x45	0.09	165	80	1.94	K75450471_PM0D045
470	35x35	0.09	180	90	1.88	K75450471_PM0E035
560	30x50	0.09	150	70	2.12	K75450561_PM0D050
560	35x40	0.09	154	76	2.12	K75450561_PM0E040
680	35x45	0.09	133	65	2.38	K75450681_PM0E045
820	35x50	0.09	115	57	2.66	K75450821_PM0E050
1000	35x60	0.10	91	45	3.31	K75450102_PM0E060
1200	40x60	0.10	79	43	3.74	K75450122_PM0F060
1500	45x60	0.10	59	32	4.30	K75450152_PM0N060
1800	40x97	0.10	52	30	5.10	K75450182_PM0F097
1800	45x77	0.10	50	25	5.20	K75450182_PM0N077
1800	50x60	0.10	53	29	4.60	K75450182_PM0V060
2200	50x77	0.10	44	24	5.60	K75450222_PM0V077
2700	45x105	0.10	34	17	6.50	K75450272_PM0N105
3300	50x105	0.10	30	17	7.50	K75450332_PM0V105

**RATED  
VOLTAGE  
VDC**

**450V**

PLEASE TO CONTACT OUR TECHNICAL SERVICE FOR MORE INFORMATION.

# K76 TYPE -40°C +85°C 5000H

RoHS Compliant

- Design optimized for extremely high miniaturization.
- Surge-proof capacitor in aluminium can with insulation sleeve.
- Snap in terminals for PCB mounting.

## APPLICATIONS

Designed for professional application.  
Ultra compact UPS, Solar inverters, High ripple current converters, Motor drives.

Dimensions in mm.

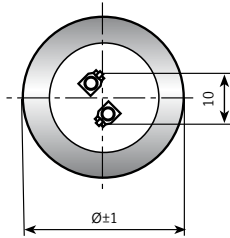
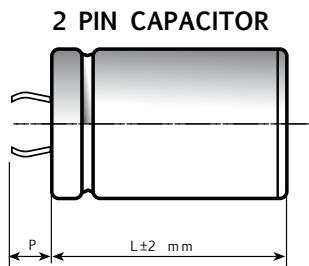

Circuit board  
hole dimensions

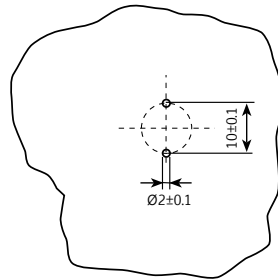

PIN LENGTH  
P 4.5 short pin  
P 6.3 long pin (standard)

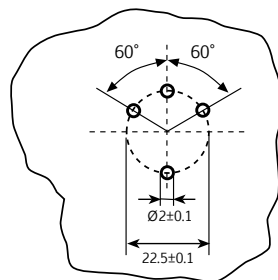
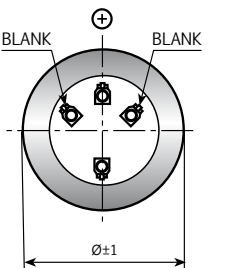
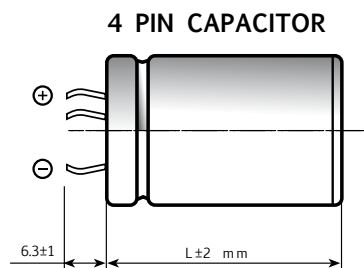
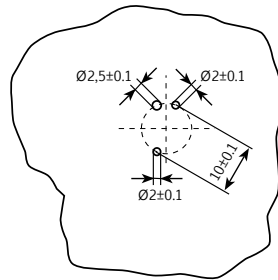
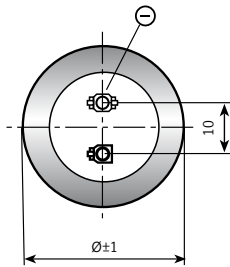
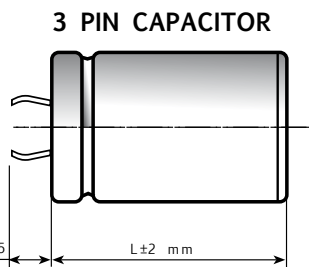

Ø	22	25	30	35	40	45	50
2 PINS	●	●	●	●	●		
3 PINS		●	●	●			
4 PINS				●	●	●	●

On demand, only for capacitors with diam ≥ 35mm: octagonal can shape for long stress vibration applications.

## SPECIFICATIONS

<b>Temperature Range</b>	Operating : -40°C +85°C [ Environmental classification 40/85/56 IEC-68 ] Storage : Preferably below +25°C, not exceeding +40°C									
<b>Rated Voltage Range (V<sub>r</sub>)</b>	from 200V to 450V DC									
<b>Surge Voltage (V<sub>p</sub>)</b>	$V_p = 1.10 V_r$									
<b>Rated Capacitance Range</b>	from 220 µF to 5600 µF									
<b>Capacitance Tolerance</b>	±20% at 100 Hz, 20°C [M class IEC-62] on request : -10% +30% at 100 Hz, 20°C [Q class IEC-62]									
<b>Leakage Current (I<sub>L</sub>) (mA, 5 min, 20°C)</b>	$\max I_L = 0.006 C_r V_r + 4 \mu A$									
<b>Ripple current (I<sub>r</sub>)</b>	Refer to table at 85°C and 100Hz :									
	FREQUENCY	50Hz	100Hz	500Hz	1000Hz	>10kHz				
	MULTIPLIER	0.8	1.0	1.2	1.3	1.5				
	AMBIENT TEMP	35°C	45°C	55°C	65°C	75°C	85°C	95°C		
	MULTIPLIER	2.2	2.1	1.8	1.6	1.4	1.0	0.5		
<b>Insulation Resistance</b>	At 100V DC for 1 min is >100 MΩ across insulating sleeve and terminals.									
<b>Vibration Resistance</b>	Frequency range : 10 Hz to 55 Hz, amplitude 0.75 mm max acceleration 10g for 3x2 h									
<b>Life test (85°C, V<sub>n</sub>, I<sub>r</sub> applied)</b>	After 2,000 hours application of rated voltage at 85°C capacitors meet characteristics aside				Cap change	≤ 10%				
					tan δ	≤ 130%				
					Leakage current (I <sub>L</sub> )	< initial limit				
					Impedance (Z)	≤ 130%				
<b>Shelf life</b>	After leaving capacitors under no load for 500 hours at 85°C, when restored at 20°C meet specifications aside				Cap change	≤ ±15%				
					tan δ	≤ 150%				
					Leakage current (I <sub>L</sub> )	< initial limit				
<b>Useful life (85°C, V<sub>n</sub>, I<sub>r</sub> applied)</b>	≥ 5,000 h at 85°C	D≤35mm		Cap change					≤ 20%	
	≥ 12,000 h at 85°C	D>40mm		tan δ					≤ 200%	
					Leakage current (I <sub>L</sub> )					< initial limit
					Impedance (Z)					≤ 200%
<b>Failure percentage</b>	≤ 1% (during working life)									
<b>Failure rate</b>	≤ 33 fit (33 10 <sup>-9</sup> /h)									
<b>Self inductance</b>	Approx. 15 nH									
<b>Reference standards</b>	CECC 30.300 IEC 60384-4 LONG LIFE GRADE									

## K76 TYPE STANDARD RATINGS

Cap µF	Ø x L mm	Tan δ MAX 100 Hz 20°C	ESR TYP mΩ 100 Hz 20°C	Z TYP mΩ 10 kHz 20°C	Ir a.c. A max 100 Hz 85°C	PART NUMBER termination digit excluded
560	25x30	0.09	106	39	3.05	K76200561_PM0C030
680	25x35	0.09	85	32	3.63	K76200681_PM0C035
820	25x40	0.09	67	25	4.04	K76200821_PM0C040
820	30x30	0.09	84	34	3.87	K76200821_PM0D030
1000	25x45	0.10	61	23	4.72	K76200102_PM0C045
1000	30x35	0.10	68	30	4.56	K76200102_PM0D035
1000	35x30	0.10	75	37	4.43	K76200102_PM0E030
1200	25x50	0.10	53	22	5.23	K76200122_PM0C050
1200	30x40	0.10	58	25	5.15	K76200122_PM0D040
1200	35x30	0.10	69	33	4.45	K76200122_PM0E030
1500	30x45	0.10	50	22	5.86	K76200152_PM0D045
1500	35x35	0.10	58	26	5.22	K76200152_PM0E035
1800	35x40	0.10	53	27	5.97	K76200182_PM0E040
2200	35x45	0.10	46	24	6.72	K76200222_PM0E045
2200	35x50	0.10	46	24	7.43	K76200222_PM0E050
2700	35x60	0.10	33	17	8.89	K76200272_PM0E060
3300	40x60	0.10	32	18	9.64	K76200332_PM0F060

**RATED  
VOLTAGE  
VDC**

**200V**

Cap µF	Ø x L mm	Tan δ MAX 100 Hz 20°C	ESR TYP mΩ 100 Hz 20°C	Z TYP mΩ 10 kHz 20°C	Ir a.c. A max 100 Hz 85°C	PART NUMBER termination digit excluded
390	25x30	0.09	141	52	2.68	K76250391_PM0C030
470	25x35	0.09	111	42	3.17	K76250471_PM0C035
560	30x30	0.09	106	44	3.45	K76250561_PM0D030
680	25x45	0.09	80	33	4.09	K76250681_PM0C045
760	30x35	0.09	82	35	4.05	K76250761_PM0D035
820	30x40	0.09	75	30	4.50	K76250821_PM0D040
820	35x30	0.09	84	36	4.07	K76250821_PM0E030
1000	30x45	0.10	60	26	5.25	K76250102_PM0D045
1000	35x35	0.10	66	32	4.80	K76250102_PM0E035
1200	30x50	0.10	55	22	5.75	K76250122_PM0D050
1200	35x40	0.10	55	22	5.44	K76250122_PM0E040
1500	35x50	0.10	48	22	6.80	K76250152_PM0E050
2200	35x60	0.10	39	18	8.12	K76250222_PM0E060
2500	40x60	0.10	31	18	9.50	K76250252_PM0F060

**RATED  
VOLTAGE  
VDC**

**250V**



## K76 TYPE STANDARD RATINGS

**RATED  
VOLTAGE  
VDC**

**350V**

Cap µF	Ø x L mm	Tan δ MAX 100 Hz 20°C	ESR TYP mΩ 100 Hz 20°C	Z TYP mΩ 10 kHz 20°C	Ir a.c. A max 100 Hz 85°C	PART NUMBER termination digit excluded
330	25x30	0.09	238	117	1.91	K76350331_PM0C030
390	25x35	0.09	225	114	2.25	K76350391_PM0C035
470	30x30	0.09	208	107	2.53	K76350471_PM0D030
520	30x30	0.09	195	105	2.55	K76350521_PM0D030
560	30x35	0.09	169	87	2.93	K76350561_PM0D035
560	30x40	0.09	169	87	3.14	K76350561_PM0D040
620	30x35	0.09	149	76	3.00	K76350621_PM0D050
680	30x40	0.09	127	66	3.34	K76350681_PM0D040
680	35x40	0.09	142	79	3.11	K76350681_PM0E040
820	30x45	0.09	111	57	3.77	K76350821_PM0D045
820	35x35	0.09	134	77	3.59	K76350821_PM0E035
880	30x45	0.09	110	57	3.78	K76350881_PM0D045
920	30x50	0.09	104	56	4.19	K76350921_PM0D050
1000	35x40	0.10	102	56	4.12	K76350102_PM0E040
1200	35x45	0.10	88	49	4.63	K76350122_PM0E045
1400	35x50	0.10	83	46	5.18	K76350142_PM0E050
1700	35x60	0.10	68	40	6.17	K76350172_PM0E060
2200	40x60	0.10	60	38	7.10	K76350222_PM0F060
2400	45x60	0.10	45	26	7.60	K76350242_PM0N060
2900	45x77	0.10	42	25	9.50	K76350292_PM0N077
2900	50x60	0.10	41	26	8.85	K76350292_PM0V060
3100	40x97	0.10	40	24	9.00	K76350312_PM0F097
3700	50x77	0.10	34	22	9.80	K76350372_PM0V077
4400	45x105	0.10	26	15	12.50	K76350442_PM0N105
4700	50x105	0.10	25	15	13.60	K76350472_PM0V105
5600	50x105	0.10	23	15	14.00	K76350562_PM0V105

**RATED  
VOLTAGE  
VDC**

**400V**

Cap µF	Ø x L mm	Tan δ MAX 100 Hz 20°C	ESR TYP mΩ 100 Hz 20°C	Z TYP mΩ 10 kHz 20°C	Ir a.c. A max 100 Hz 85°C	PART NUMBER termination digit excluded
220	25x30	0.09	328	148	1.70	K76400221_PM0C030
330	25x35	0.09	240	115	2.10	K76400331_PM0C035
390	30x30	0.09	230	112	2.35	K76400391_PM0D030
470	30x35	0.09	190	91	2.75	K76400471_PM0D035
560	30x40	0.09	160	78	3.11	K76400561_PM0D040
560	35x30	0.09	183	97	2.92	K76400561_PM0E030
680	30x45	0.09	126	60	3.55	K76400681_PM0D045
680	35x35	0.09	140	64	3.44	K76400681_PM0E035
720	30x50	0.09	121	59	3.89	K76400721_PM0D050
780	35x40	0.09	128	67	3.85	K76400781_PM0E040
820	35x45	0.09	114	59	4.32	K76400821_PM0E045
1000	35x50	0.10	97	51	4.85	K76400102_PM0E050
1200	35x60	0.10	79	41	5.77	K76400122_PM0E060
1700	40x60	0.10	67	39	6.70	K76400172_PM0F060
2000	45x60	0.10	49	28	8.36	K76400202_PM0N060
2200	45x77	0.10	46	26	8.8	K76400222_PM0N077
2200	50x60	0.10	45	26	8.1	K76400222_PM0V060
2400	40x97	0.10	43	25	8.8	K76400242_PM0F097
2400	45x77	0.10	42	23	8.8	K76400242_PM0N077
2400	50x60	0.10	45	26	8.8	K76400242_PM0V060
2900	50x77	0.10	38	22	10.0	K76400292_PM0V077
3300	45x105	0.10	30	18	11.8	K76400332_PM0N105
3300	50x105	0.10	28	16	12.80	K76400332_PM0V105
4400	50x105	0.10	26	15	13.40	K76400442_PM0V105

## K76 TYPE STANDARD RATINGS

Cap µF	Ø x L mm	Tan δ MAX 100 Hz 20°C	ESR TYP mΩ 100 Hz 20°C	Z TYP mΩ 10 kHz 20°C	Ir a.c. A max 100 Hz 85°C	PART NUMBER termination digit excluded
290	25x35	0.09	273	123	2.02	K76420291_PM0C035
330	30x30	0.09	256	118	2.30	K76420331_PM0D030
470	30x35	0.09	178	81	2.76	K76420471_PM0D035
520	30x40	0.09	170	80	3.02	K76420521_PM0D040
520	35x30	0.09	180	87	2.86	K76420521_PM0E030
560	30x45	0.09	149	69	3.48	K76420561_PM0D045
560	35x35	0.09	165	82	3.33	K76420561_PM0E035
620	30x45	0.09	150	72	3.50	K76420621_PM0D045
620	35x35	0.09	150	72	3.40	K76420621_PM0E035
680	30x50	0.09	127	60	3.80	K76420681_PM0D050
680	35x45	0.09	127	60	3.80	K76420681_PM0E045
820	35x45	0.09	115	55	4.23	K76420821_PM0E045
920	35x50	0.09	100	51	4.73	K76420921_PM0E050
1000	35x60	0.10	84	44	5.51	K76420102_PM0E060
1200	35x60	0.10	80	42	5.65	K76420122_PM0E060
1500	40x60	0.10	69	38	6.58	K76420152_PM0F060
1700	45x60	0.10	53	28	7.5	K76420172_PM0N060
2000	45x77	0.10	44	23	8.2	K76420202_PM0N077
2200	40x97	0.10	45	26	8.3	K76420222_PM0F097
2200	50x60	0.10	47	27	8.0	K76420222_PM0V060
2700	50x77	0.10	40	22	9.5	K76420272_PM0V077
3100	45x105	0.10	31	16	11.41	K76420312_PM0N105
3300	50x105	0.10	28	16	12.80	K76420332_PM0V105
3900	50x105	0.10	27	16	13.00	K76420392_PM0V105

**RATED  
VOLTAGE  
VDC**

**420V**

Cap µF	Ø x L mm	Tan δ MAX 100 Hz 20°C	ESR TYP mΩ 100 Hz 20°C	Z TYP mΩ 10 kHz 20°C	Ir a.c. A max 100 Hz 85°C	PART NUMBER termination digit excluded
220	25x35	0.09	325	145	1.87	K76450221_PM0C035
270	25x35	0.09	283	132	1.89	K76450271_PM0C035
330	30x30	0.09	228	107	2.13	K76450331_PM0D030
390	30x35	0.09	200	92	2.51	K76450391_PM0D035
470	30x40	0.09	165	80	2.85	K76450471_PM0D040
560	30x45	0.09	150	70	3.24	K76450561_PM0D045
560	35x35	0.09	154	76	3.12	K76450561_PM0E035
620	30x50	0.09	140	66	3.53	K76450621_PM0D050
680	35x40	0.09	133	65	3.56	K76450681_PM0E040
750	35x45	0.09	126	64	3.95	K76450751_PM0E045
820	35x50	0.09	109	56	4.41	K76450821_PM0E050
1000	35x60	0.10	91	45	5.33	K76450102_PM0E060
1500	40x60	0.10	74	32	6.22	K76450152_PM0F060
1600	45x60	0.10	58	30	6.5	K76450162_PM0N060
2000	40x97	0.10	50	27	7.2	K76450202_PM0F097
2000	45x77	0.10	48	25	7.6	K76450202_PM0N077
2000	50x60	0.10	52	29	7.3	K76450202_PM0V060
2400	50x77	0.10	43	24	9.70	K76450242_PM0V077
2700	45x105	0.10	33	17	10.50	K76450272_PM0N105
3300	50x105	0.10	30	17	12.10	K76450332_PM0V105
3600	50x105	0.10	29	16	12.20	K76450362_PM0V105

**RATED  
VOLTAGE  
VDC**

**450V**

PLEASE TO CONTACT OUR TECHNICAL SERVICE FOR MORE INFORMATION.

# K85 TYPE -40°C +105°C 8000H

RoHS Compliant

- Design optimized for high ripple current and very long life application.
- Surge-proof capacitor in aluminium can with insulation sleeve.
- Snap in terminals for PCB mounting.

## APPLICATIONS

Designed for professional application.  
Ultra compact UPS, Solar inverters, High ripple current converters, Motor drives.

Dimensions in mm.

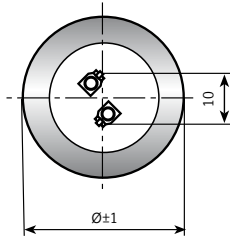
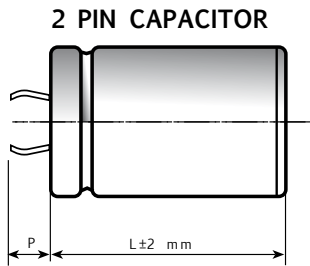

Circuit board hole dimensions

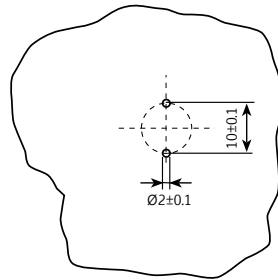

PIN LENGTH  
P 4.5 short pin  
P 6.3 long pin (standard)

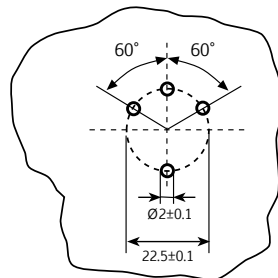
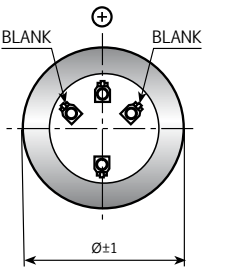
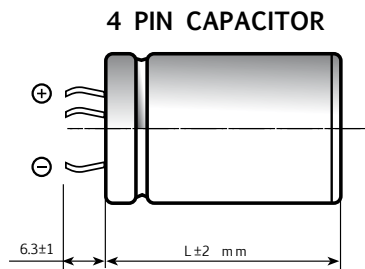
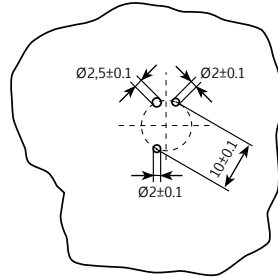
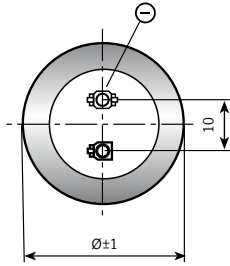
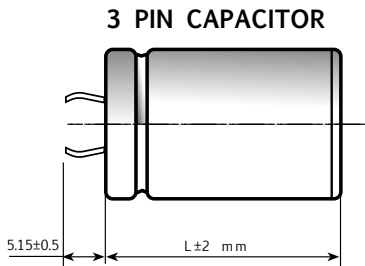

Ø	22	25	30	35	40	45	50
2 PINS	●	●	●	●	●		
3 PINS		●	●	●			
4 PINS				●	●	●	●

On demand, only for capacitors with diam ≥ 35mm: octagonal can shape for long stress vibration applications.

## SPECIFICATIONS

<b>Temperature Range</b>	Operating : -40°C +105°C Storage : Preferably below +25°C, not exceeding +40°C	
<b>Rated Voltage Range (V<sub>r</sub>)</b>	from 350V to 450V DC	
<b>Surge Voltage (V<sub>p</sub>)</b>	V <sub>p</sub> = 1.10 V <sub>r</sub>	
<b>Rated Capacitance Range</b>	from 100 µF to 1000 µF	
<b>Capacitance Tolerance</b>	±20% at 100 Hz, 20°C [M class IEC-62]	
<b>Leakage Current (I<sub>L</sub>) (mA, 5 min, 20°C)</b>	max I <sub>L</sub> = 0.006 C <sub>r</sub> V <sub>r</sub> + 4 µA	
<b>Ripple current (I<sub>r</sub>)</b>	Refer to table at 105°C and 100Hz :	
	FREQUENCY	50Hz    100Hz    500Hz    1000Hz    >10kHz
	MULTIPLIER	0.88    1.0    1.45    1.5    1.55
	AMBIENT TEMP	35°C    45°C    55°C    65°C    75°C    85°C    95°C    105°C
	MULTIPLIER	3.0    2.8    2.6    2.4    2.2    1.8    1.5    1
<b>Insulation Resistance</b>	At 100V DC for 1 min is >100 MΩ across insulating sleeve and terminals.	
<b>Vibration Resistance</b>	Frequency range : 10 Hz to 55 Hz, amplitude 0.75 mm max acceleration 10g for 3x2 h	
<b>Life test (105°C, V<sub>n</sub>, I<sub>r</sub> applied)</b>	After 3,000 hours application of rated voltage at 105°C capacitors meet characteristics aside	Cap change ≤ 10% tan δ ≤ 130% Leakage current (I <sub>L</sub> ) < initial limit Impedance (Z) ≤ 130%
<b>Shelf life</b>	After leaving capacitors under no load for 500 hours at 105°C, when restored at 20°C meet specifications aside	Cap change ≤ ±15% tan δ ≤ 150% Leakage current (I <sub>L</sub> ) < initial limit
<b>Useful life (105°C, V<sub>n</sub>, I<sub>r</sub> applied)</b>	≥ 8.000 h at 105°C	Cap change ≤ 20% tan δ ≤ 200% Leakage current (I <sub>L</sub> ) < initial limit Impedance (Z) ≤ 200%
<b>Failure percentage Failure rate</b>	≤ 1% (during useful life) ≤ 40 fit (40 10 <sup>-9</sup> /h)	
<b>Self inductance</b>	Approx. 15 nH	
<b>Reference standards</b>	CECC 30.300 IEC 60384-4 LONG LIFE GRADE	

## K85 TYPE STANDARD RATINGS

Cap $\mu\text{F}$	$\varnothing \times L$ mm	Tan $\delta$ MAX 100 Hz 20°C	ESR TYP $\text{m}\Omega$ 100 Hz 20°C	Z TYP $\text{m}\Omega$ 10 kHz 20°C	I <sub>r</sub> a.c. A max 100 Hz 105°C	PART NUMBER termination digit excluded
180	25x30	0.06	240	136	1.35	K85350181_PM0C030
220	25x35	0.06	199	121	1.57	K85350221_PM0C035
220	30x30	0.06	209	128	1.64	K85350221_PM0D030
330	25x45	0.06	136	83	2.10	K85350331_PM0C045
330	30x35	0.06	144	86	2.07	K85350331_PM0D035
390	25x50	0.06	134	83	2.29	K85350391_PM0C050
390	30x35	0.06	140	86	2.11	K85350391_PM0D035
390	30x40	0.06	140	86	2.46	K85350391_PM0D040
390	35x30	0.06	138	85	2.33	K85350391_PM0E030
470	25x55	0.07	96	77	2.59	K85350471_PM0C055
470	35x35	0.07	96	78	2.51	K85350471_PM0E035
560	30x55	0.07	78	48	3.10	K85350561_PM0D055
560	35x40	0.07	88	54	2.98	K85350561_PM0E040
680	35x45	0.07	75	45	3.20	K85350681_PM0E045
680	35x50	0.07	74	44	3.32	K85350681_PM0E050
720	35x50	0.07	67	42	3.45	K85350721_PM0E050
820	35x55	0.07	63	39	3.78	K85350821_PM0E055
1000	35x60	0.08	60	39	4.00	K85350102_PM0E060

**RATED  
VOLTAGE  
VDC**

**350V**

Cap $\mu\text{F}$	$\varnothing \times L$ mm	Tan $\delta$ MAX 100 Hz 20°C	ESR TYP $\text{m}\Omega$ 100 Hz 20°C	Z TYP $\text{m}\Omega$ 10 kHz 20°C	I <sub>r</sub> a.c. A max 100 Hz 105°C	PART NUMBER termination digit excluded
150	25x30	0.06	291	160	1.23	K85400151_PM0C030
180	25x35	0.06	240	136	1.44	K85400181_PM0C035
180	30x30	0.06	240	136	1.53	K85400181_PM0D030
220	25x45	0.06	184	102	1.81	K85400221_PM0C045
220	30x35	0.06	196	110	1.79	K85400221_PM0D035
270	25x50	0.06	185	95	1.88	K85400271_PM0C050
270	30x35	0.06	170	98	1.91	K85400271_PM0D035
270	35x30	0.06	162	92	2.07	K85400271_PM0E030
330	25x55	0.06	121	67	2.41	K85400331_PM0C055
330	30x40	0.06	152	84	2.12	K85400331_PM0D040
330	35x35	0.06	153	89	2.24	K85400331_PM0E035
390	30x50	0.06	103	55	2.71	K85400391_PM0D050
390	35x40	0.06	114	63	2.73	K85400391_PM0E040
470	30x55	0.07	97	52	3.01	K85400471_PM0D055
470	35x45	0.07	95	52	3.07	K85400471_PM0E045
560	35x50	0.07	85	45	3.20	K85400561_PM0E050
680	35x55	0.07	75	45	3.51	K85400681_PM0E055

**RATED  
VOLTAGE  
VDC**

**400V**

## K85 TYPE STANDARD RATINGS

**RATED  
VOLTAGE  
VDC**

**420V**

Cap µF	Ø x L mm	Tan δ MAX 100 Hz 20°C	ESR TYP mΩ 100 Hz 20°C	Z TYP mΩ 10 kHz 20°C	Ir a.c. A max 100 Hz 105°C	PART NUMBER termination digit excluded
120	25x30	0.06	312	181	1.19	K85420121_PM0C030
150	25x35	0.06	253	146	1.40	K85420151_PM0C035
180	30x30	0.06	240	136	1.53	K85420181_PM0D030
220	25x45	0.06	184	102	1.81	K85420221_PM0C045
220	30x35	0.06	196	110	1.79	K85420221_PM0D035
250	25x50	0.06	170	92	1.96	K85420251_PM0C050
250	30x35	0.06	185	103	1.83	K85420251_PM0D035
250	35x30	0.06	172	96	2.00	K85420251_PM0E030
270	30x40	0.06	152	84	2.12	K85420271_PM0D040
330	25x55	0.06	121	67	2.41	K85420331_PM0C055
330	35x35	0.06	153	89	2.24	K85420331_PM0E035
390	30x55	0.06	103	55	2.91	K85420391_PM0C055
390	35x40	0.06	114	63	2.71	K85420391_PM0E040
470	35x50	0.07	97	45	3.15	K85420471_PM0E050
560	35x55	0.07	85	45	3.30	K85420561_PM0E055
680	35x60	0.07	75	45	3.54	K85420681_PM0E060

**RATED  
VOLTAGE  
VDC**

**450V**

Cap µF	Ø x L mm	Tan δ MAX 100 Hz 20°C	ESR TYP mΩ 100 Hz 20°C	Z TYP mΩ 10 kHz 20°C	Ir a.c. A max 100 Hz 105°C	PART NUMBER termination digit excluded
100	25x30	0.06	388	214	1.07	K85450101_PM0C030
120	25x35	0.06	324	178	1.24	K85450121_PM0C035
150	25x40	0.06	250	142	1.48	K85450151_PM0C040
150	30x30	0.06	260	144	1.45	K85450151_PM0D030
150	30x40	0.06	250	142	1.66	K85450151_PM0D040
180	25x45	0.06	212	119	1.68	K85450181_PM0C045
180	30x35	0.06	223	126	1.67	K85450181_PM0D035
220	25x50	0.06	183	101	1.89	K85450221_PM0C050
220	30x40	0.06	197	110	1.97	K85450221_PM0D040
220	35x30	0.06	185	104	1.92	K85450221_PM0E030
270	30x45	0.06	159	86	2.21	K85450271_PM0D045
270	35x35	0.06	166	95	2.12	K85450271_PM0E035
330	30x50	0.06	127	68	2.53	K85450331_PM0D050
330	35x40	0.06	127	68	2.57	K85450331_PM0E040
390	30x55	0.06	110	59	2.82	K85450391_PM0D055
390	35x45	0.06	119	63	2.77	K85450391_PM0E045
470	35x50	0.06	106	58	3.06	K85450471_PM0E050
560	35x55	0.07	91	54	3.30	K85450561_PM0E055
560	35x60	0.07	91	54	3.42	K85450561_PM0E060
680	35x77	0.07	81	41	4.07	K85450681_PM0E077

PLEASE TO CONTACT OUR TECHNICAL SERVICE FOR MORE INFORMATION.

# K95 TYPE -40°C +105°C 5000H

RoHS Compliant

- Design optimized for high ripple current and long life application.
- Miniaturized design.
- Surge-proof capacitor in aluminium can with insulation sleeve.
- Snap in terminals for PCB mounting.

## APPLICATIONS

Designed for professional application.  
Ultra compact UPS, Solar inverters, High ripple current converters, Motor drives.

Dimensions in mm.

### 2 PIN CAPACITOR

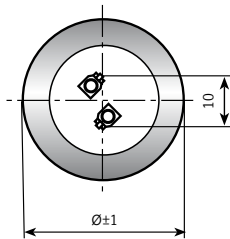
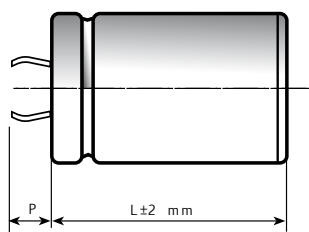

Circuit board  
hole dimensions

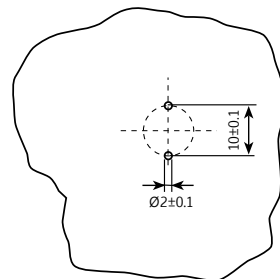

PIN LENGTH

P 4.5 short pin

P 6.3 long pin (standard)

### 3 PIN CAPACITOR

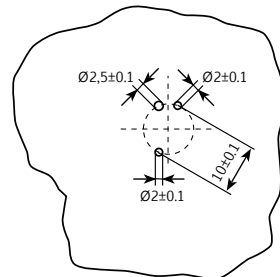
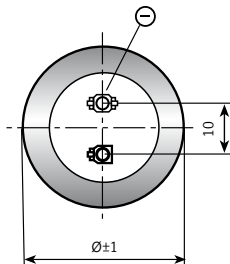
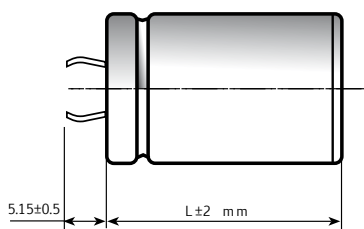

### 4 PIN CAPACITOR

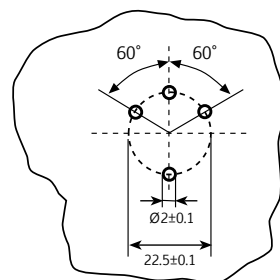
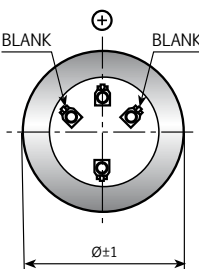
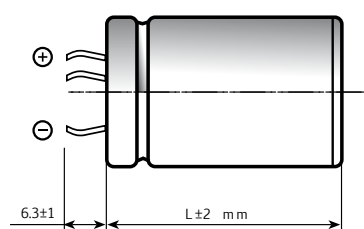

Ø	22	25	30	35	40	45	50
2 PINS	●	●	●	●	●		
3 PINS		●	●	●			
4 PINS				●	●	●	●

On demand, only for capacitors with diam ≥ 35mm: octagonal can shape for long stress vibration applications.

## SPECIFICATIONS

<b>Temperature Range</b>	Operating : -40°C +105°C Storage : Preferably below +25°C, not exceeding +40°C	
<b>Rated Voltage Range (V<sub>r</sub>)</b>	from 350V to 450V DC	
<b>Surge Voltage (V<sub>p</sub>)</b>	V <sub>p</sub> = 1.10 V <sub>r</sub>	
<b>Rated Capacitance Range</b>	from 150 µF to 1000 µF	
<b>Capacitance Tolerance</b>	±20% at 100 Hz, 20°C [M class IEC-62]	
<b>Leakage Current (I<sub>L</sub>) (mA, 5 min, 20°C)</b>	max I <sub>L</sub> = 0.006 C <sub>r</sub> V <sub>r</sub> + 4 µA	
<b>Ripple current (I<sub>r</sub>)</b>	Refer to table at 105°C and 100Hz :	
	FREQUENCY	50Hz    100Hz    500Hz    1000Hz    >10kHz
	MULTIPLIER	0.88    1.0    1.45    1.5    1.55
	AMBIENT TEMP	35°C    45°C    55°C    65°C    75°C    85°C    95°C    105°C
	MULTIPLIER	3.0    2.8    2.6    2.4    2.2    1.8    1.5    1
<b>Insulation Resistance</b>	At 100V DC for 1 min is >100 MΩ across insulating sleeve and terminals.	
<b>Vibration Resistance</b>	Frequency range : 10 Hz to 55 Hz, amplitude 0.75 mm max acceleration 10g for 3x2 h	
<b>Life test (105°C, V<sub>n</sub>, I<sub>r</sub> applied)</b>	After 2,000 hours application of rated voltage at 105°C capacitors meet characteristics aside	Cap change ≤ 10% tan δ ≤ 130% Leakage current (I <sub>L</sub> ) < initial limit Impedance (Z) ≤ 130%
<b>Shelf life</b>	After leaving capacitors under no load for 500 hours at 105°C, when restored at 20°C meet specifications aside	Cap change ≤ ±15% tan δ ≤ 150% Leakage current (I <sub>L</sub> ) < initial limit
<b>Useful life (105°C, V<sub>n</sub>, I<sub>r</sub> applied)</b>	≥ 5.000 h at 105°C	Cap change ≤ 20% tan δ ≤ 200% Leakage current (I <sub>L</sub> ) < initial limit Impedance (Z) ≤ 200%
<b>Failure percentage Failure rate</b>	≤ 1% (during useful life) ≤ 40 fit (40 10 <sup>-9</sup> /h)	
<b>Self inductance</b>	Approx. 15 nH	
<b>Reference standards</b>	CECC 30.300 IEC 60384-4 LONG LIFE GRADE	



## K95 TYPE STANDARD RATINGS

Cap µF	Ø x L mm	Tan δ MAX 100 Hz 20°C	ESR TYP mΩ 100 Hz 20°C	Z TYP mΩ 10 kHz 20°C	I <sub>r</sub> a.c. A max 100 Hz 105°C	PART NUMBER termination digit excluded
220	25x30	0.10	247	136	1.20	K95350221_PM0C030
270	25x35	0.10	223	111	1.39	K95350271_PM0C035
330	25x35	0.10	165	91	1.50	K95350331_PM0C035
330	30x30	0.10	165	91	1.53	K95350331_PM0D030
390	25x40	0.10	135	75	1.75	K95350391_PM0C040
390	30x35	0.10	135	75	1.80	K95350391_PM0D035
470	25x50	0.10	131	70	2.11	K95350471_PM0C050
470	35x30	0.10	131	70	2.11	K95350471_PM0E030
560	25x55	0.11	115	60	2.45	K95350561_PM0C055
560	30x40	0.11	120	60	2.23	K95350561_PM0D040
560	35x35	0.11	120	70	2.26	K95350561_PM0E035
680	30x55	0.11	108	65	2.85	K95350681_PM0D055
680	35x40	0.11	108	68	2.59	K95350681_PM0E040
820	35x50	0.11	85	46	3.15	K95350821_PM0E050
1000	35x60	0.11	63	40	3.82	K95350102_PM0E060

**RATED  
VOLTAGE  
VDC**

**350V**

Cap µF	Ø x L mm	Tan δ MAX 100 Hz 20°C	ESR TYP mΩ 100 Hz 20°C	Z TYP mΩ 10 kHz 20°C	I <sub>r</sub> a.c. A max 100 Hz 105°C	PART NUMBER termination digit excluded
150	25x30	0.10	351	186	1.05	K95400151_PM0C030
180	25x30	0.10	297	159	1.14	K95400181_PM0C030
220	25x35	0.10	240	130	1.34	K95400221_PM0C035
220	30x30	0.10	247	136	1.41	K95400221_PM0D030
270	25x40	0.10	199	107	1.55	K95400271_PM0C040
270	30x35	0.10	201	111	1.60	K95400271_PM0D035
330	25x50	0.10	165	90	1.86	K95400331_PM0C050
330	30x35	0.10	167	91	1.80	K95400331_PM0D035
330	35x30	0.10	167	91	1.90	K95400331_PM0E030
390	25x55	0.10	141	68	2.20	K95400391_PM0C055
390	30x40	0.10	145	70	2.10	K95400391_PM0D040
390	35x35	0.10	148	75	2.10	K95400391_PM0E035
470	30x50	0.10	138	69	2.51	K95400471_PM0D050
470	35x40	0.10	138	69	2.53	K95400471_PM0E040
560	30x55	0.11	115	60	2.79	K95400561_PM0D055
560	35x40	0.11	115	60	2.65	K95400561_PM0E040
680	35x50	0.11	108	59	3.18	K95400681_PM0E050
820	35x55	0.11	85	46	3.65	K95400821_PM0E055
920	35x60	0.11	63	40	3.95	K95400921_PM0E060

**RATED  
VOLTAGE  
VDC**

**400V**

## K95 TYPE STANDARD RATINGS

Cap $\mu\text{F}$	$\varnothing \times \text{L}$ mm	Tan $\delta$ MAX 100 Hz 20°C	ESR TYP $\text{m}\Omega$ 100 Hz 20°C	Z TYP $\text{m}\Omega$ 10 kHz 20°C	I <sub>r</sub> a.c. A max 100 Hz 105°C	PART NUMBER termination digit excluded
150	25x30	0.10	351	186	1.05	K95420151_PM0C030
180	25x30	0.10	297	159	1.14	K95420181_PM0C030
220	25x35	0.10	240	133	1.34	K95420221_PM0C035
220	30x30	0.10	247	136	1.41	K95420221_PM0D030
270	25x40	0.10	199	107	1.55	K95420271_PM0C040
270	30x35	0.10	201	111	1.64	K95420271_PM0D035
330	25x50	0.10	165	90	1.86	K95420331_PM0C050
330	30x35	0.10	167	91	1.80	K95420331_PM0D035
330	35x30	0.10	167	91	1.90	K95420331_PM0E030
390	25x55	0.10	141	68	2.20	K95420391_PM0C055
390	30x40	0.10	145	70	2.10	K95420391_PM0D040
390	35x35	0.10	148	75	2.10	K95420391_PM0E035
470	30x50	0.10	138	69	2.51	K95420471_PM0D050
470	35x40	0.10	138	69	2.53	K95420471_PM0E040
560	30x55	0.11	115	60	2.79	K95420561_PM0D055
560	35x45	0.11	115	60	2.85	K95420561_PM0E045
680	35x50	0.11	108	59	3.18	K95420681_PM0E050
820	35x60	0.11	85	46	3.85	K95420821_PM0E060

**RATED  
VOLTAGE  
VDC**

**420V**

Cap $\mu\text{F}$	$\varnothing \times \text{L}$ mm	Tan $\delta$ MAX 100 Hz 20°C	ESR TYP $\text{m}\Omega$ 100 Hz 20°C	Z TYP $\text{m}\Omega$ 10 kHz 20°C	I <sub>r</sub> a.c. A max 100 Hz 105°C	PART NUMBER termination digit excluded
150	25x30	0.10	367	186	1.02	K95450151_PM0C030
150	30x30	0.10	367	186	1.15	K95450151_PM0D030
180	25x40	0.10	287	146	1.30	K95450181_PM0C040
180	30x30	0.10	293	152	1.28	K95450181_PM0D030
220	25x40	0.10	255	136	1.38	K95450221_PM0C040
220	30x30	0.10	255	136	1.36	K95450221_PM0D030
220	35x30	0.10	255	136	1.57	K95450221_PM0E030
270	30x40	0.10	204	106	1.71	K95450271_PM0D040
270	35x30	0.10	204	106	1.71	K95450271_PM0E030
330	30x50	0.10	173	90	2.11	K95450331_PM0D050
330	35x40	0.10	173	90	2.12	K95450331_PM0E040
390	30x50	0.10	155	75	2.26	K95450391_PM0D050
390	35x40	0.10	155	75	2.26	K95450391_PM0E040
470	35x50	0.10	142	71	2.73	K95450471_PM0E050
560	35x55	0.11	120	60	3.10	K95450561_PM0E055
680	35x60	0.11	110	59	3.40	K95450681_PM0E060

**RATED  
VOLTAGE  
VDC**

**450V**

PLEASE TO CONTACT OUR TECHNICAL SERVICE FOR MORE INFORMATION.

## K13 TYPE MOTOR START

RoHS Compliant

- Surge-proof electrolytic capacitor in plastic case.
- Poles brought out to single or double fast-on terminals
- Normally supplied with end cup.
- On request: bipolar cable, discharge resistance, metal mounting bracket, with or without cover.

### APPLICATIONS

Non polarized capacitor especially designed for intermittent A.C. voltage applications at 50-60 Hz for single phase motor starting.

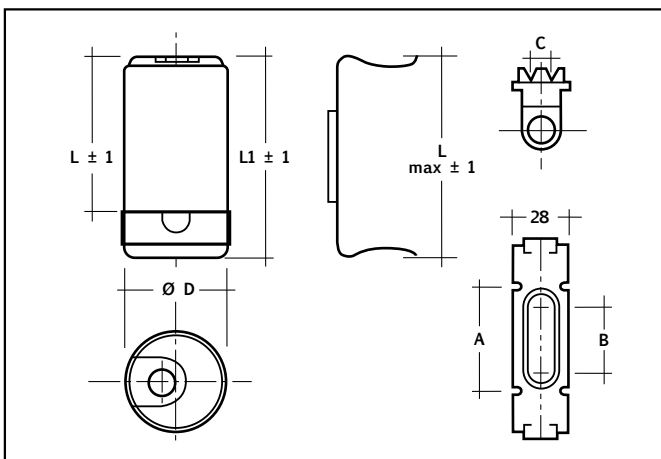

	Case			Bracket		
	Ø est. mm.	L mm.	L1 mm.	Lmax mm.	A mm.	B x C mm.
<b>B2</b>	46	85.7	98.4	104	53	37 x 6.1

## SPECIFICATIONS

<b>Operating Temperature Range</b>	(Operating) -25°C +75°C (Storage) -40°C +85°C
<b>Working Voltage Range</b>	from 125V AC to 320V AC
<b>Capacitance Range</b>	from 25 µF to 800 µF
<b>Capacitance Tolerance</b>	-0% +25% or ±10%
<b>Tan δ (Dissipation loss angle)</b>	Measurement frequency: 100 Hz, temperature 20°C Value shall not exceed 0.10 and shall be calculated as follows: $\tan d = W / ( V \times I ) = ( \text{true watts} / \text{apparent watts} )$
<b>Capacitance Measurement</b>	Capacitance shall be determined by measuring the current (after 2÷3 seconds of energising) through the capacitors at rated voltage and frequency. The capacitance is defined from the following formula: $C = ( I \times 10^6 ) / 2 \pi p \times f V$ C = capacitance in µF I = current in Amperes $\pi$ = 3.14 constant f = frequency in Hz V = applied AC voltage in Volt
<b>Working condition</b>	The standard time rating defined of the IEC 252 is 1.67% or 1/60 <sup>th</sup> full time and corresponds to a duty cycle of 3 seconds on and 177 seconds off. Alternative customer duty is available on request.
<b>Endurance test</b>	500 hours
<b>Reference standards</b>	IEC 252

## K13 TYPE STANDARD RATINGS

RoHS Compliant

Cap μF	PART NUMBER digit_15=0 no cover	PART NUMBER digit_15=1 with cover	PART NUMBER digit_15=2 with cover + bracket
-----------	------------------------------------	--------------------------------------	---

**VOLTAGE**

100-125	K1312510000000B2	K1312510000001B2	K1312510000002B2
125-160	K1312512500000B2	K1312512500001B2	K1312512500002B2
160-200	K1312516000000B2	K1312516000001B2	K1312516000002B2
200-250	K1312520000000B2	K1312520000001B2	K1312520000002B2
250-315	K1312525000000B2	K1312525000001B2	K1312525000002B2
315-400	K1312531500000B2	K1312531500001B2	K1312531500002B2
600	K1312560000000B2	K1312560000001B2	K1312560000002B2
800	K1312580000000B2	K1312580000001B2	K1312580000002B2

**125VAC**

Cap μF	PART NUMBER digit_15=0 no cover	PART NUMBER digit_15=1 with cover	PART NUMBER digit_15=2 with cover + bracket
-----------	------------------------------------	--------------------------------------	---

**VOLTAGE**

25-31	K1325002500000B2	K1325002500001B2	K1325002500002B2
31-40	K1325003100000B2	K1325003100001B2	K1325003100002B2
40-50	K1325004000000B2	K1325004000001B2	K1325004000002B2
50-63	K1325005000000B2	K1325005000001B2	K1325005000002B2
63-80	K1325006300000B2	K1325006300001B2	K1325006300002B2
80-100	K1325008000000B2	K1325008000001B2	K1325008000002B2
100-125	K1325010000000B2	K1325010000001B2	K1325010000002B2
125-160	K1325012500000B2	K1325012500001B2	K1325012500002B2
160-200	K1325016000000B2	K1325016000001B2	K1325016000002B2
200-250	K1325020000000B2	K1325020000001B2	K1325020000002B2
250-315	K1325025000000B2	K1325025000001B2	K1325025000002B2
315-400	K1325031500000B2	K1325031500001B2	K1325031500002B2
400	K1325040000000B2	K1325040000001B2	K1325040000002B2
500	K1325050000000B2	K1325050000001B2	K1325050000002B2

**250VAC**

Cap μF	PART NUMBER digit_15=0 no cover	PART NUMBER digit_15=1 with cover	PART NUMBER digit_15=2 with cover + bracket
-----------	------------------------------------	--------------------------------------	---

**VOLTAGE**

25-31	K1332002500000B2	K1332002500001B2	K1332002500002B2
31-40	K1332003100000B2	K1332003100001B2	K1332003100002B2
40-50	K1332004000000B2	K1332004000001B2	K1332004000002B2
50-63	K1332005000000B2	K1332005000001B2	K1332005000002B2
63-80	K1332006300000B2	K1332006300001B2	K1332006300002B2
80-100	K1332008000000B2	K1332008000001B2	K1332008000002B2
100-125	K1332010000000B2	K1332010000001B2	K1332010000002B2
125-160	K1332012500000B2	K1332012500001B2	K1332012500002B2
160-200	K1332016000000B2	K1332016000001B2	K1332016000002B2
200-250	K1332020000000B2	K1332020000001B2	K1332020000002B2
250-315	K1332025000000B2	K1332025000001B2	K1332025000002B2

**320VAC**

## RINGS CLIPS

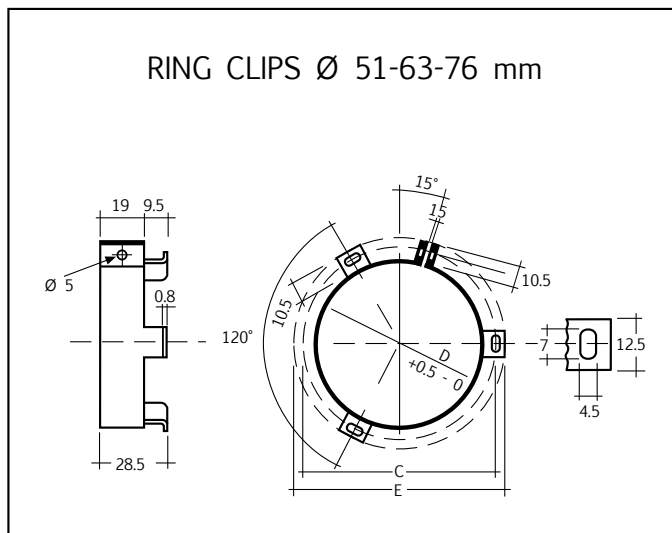
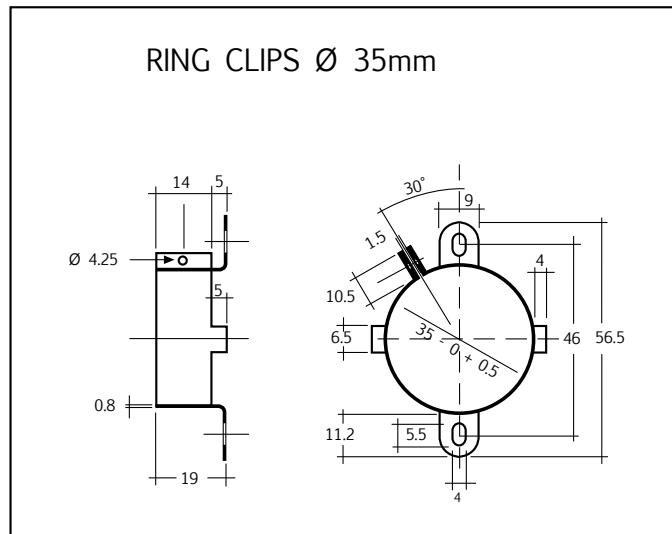

D	C	E	ORDERING CODE
35	46	56.5	1635000
51	63.5	73.4	1650000
63	76.0	86.1	1664000
76	89.0	98.6	1676000

## INSULATED HEX NUTS, WASHERS

**TO BE USED WITH SCREW TYPE CAPACITORS**  
**DIMENSIONS mm**

THREAD	DESCRIPTION	Ø	h	H	D	ORDERING CODE
M12	NUT S17	17	1.3	18	28	1300010
M12	NUT S17 + FLAT WASHER					1300011
M12	NUT S15	15	1.3	18	25	1300012
M12	NUT S15 + FLAT WASHER					1300013
M12	NUT S22	22	1.3	18	28	1300014
M12	NUT S22 + FLAT WASHER					1300015
M8	NUT M8	17	1.3	15	25	1300016
M8	NUT M8 + FLAT WASHER					1300017
M12	CENTER RING WASHER					1300001

### INSULATED MOUNTING WITH HEX NUT

HEX NUTS AND SPRING WASHERS ARE DELIVERED LOOSELY WITH THE CAPACITOR.  
 INSULATION WASHERS SHALL BE ORDERED SEPARATELY.

M	A	B	C
8	8.4	25	18.5
12	12.5	35	18.5

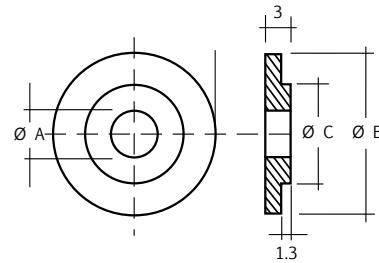

**CENTER RING WASHER**

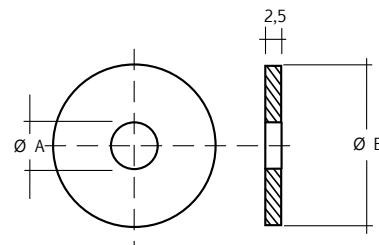
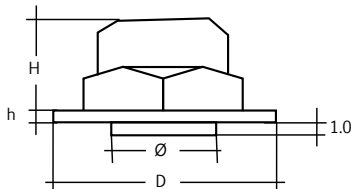

**FLAT WASHER**

## MOUNTING HARDWARE

During normal operation electrolytic capacitors are subjected to an internal generation of gas due to heating combined with the inside pressure. Therefore a safety vent is provided to prevent catastrophic failure

**Kendeil aluminium electrolytic capacitors screw terminals type** have been provided with a safety vent plug on the deck, a tiny rubber capsule designed to support a critical bursting pressure up to 8 bar. To fix these capacitors use the appropriate mounting clamps furnished in different diameter size

**Kendeil aluminium electrolytic capacitors snap in terminals type** do have a kind of vent, realized as a weakened area in the base of the alum can, sometimes also by side, that will release the possible growth of excess pressure. Usually board mounted type are easily fixed by their own terminals, and so no special mounting hardware is then required.

When mounting the capacitor, it should be borne in mind that in the event of the vent being blown under failure conditions, a small quantity of hot conductive electrolyte and vapours can, in some cases, flow out from the vent, so the position is important and the can should be carefully located. If possible, we recommend that capacitors are mounted with the safety vent uppermost.

In any case, screws terminal capacitors can be mounted in any position so long as the vent is free to operate.

The overall characteristic parameters such as capacitance, ESR, currents, etc. remain the same whatever is the orientation, but once the vent has been blown, an eventual overflow of electrolyte could damage important parts of the circuit.

Lastly, a good cooling system must be designed. Consideration must be given as to where to place the circuits especially when dealing with high ripple currents; the area around electrolytic capacitors should be well aired with enough distance between the radiant elements, both for maintenance and for security reasons.

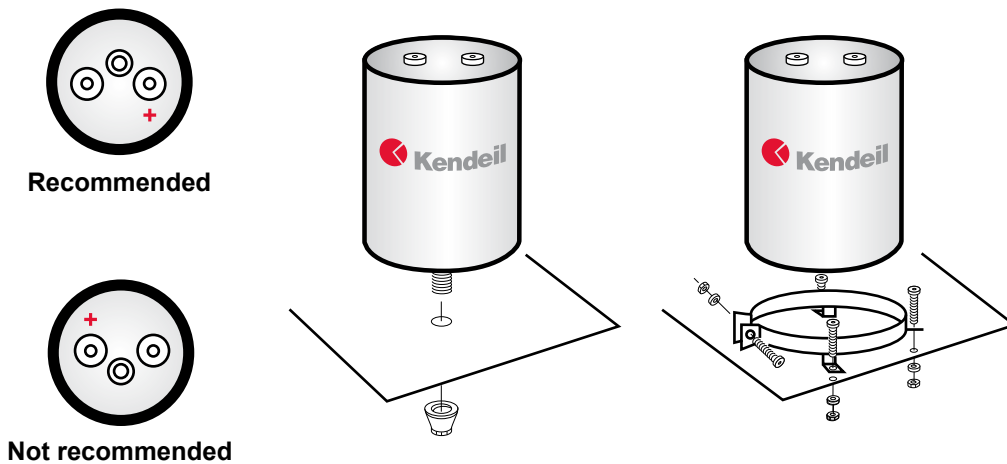

### Notes when mounting a screw type capacitors:

Special attention has to be applied during assembling in case of stud capacitors. The threaded stud termination (M8 or M12 diameter) is the bottom part of capacitor's can and it's in electrical contact with negative end termination of capacitor. Please use our plastic nut and plastic ring or other well protected system in order to avoid short circuit between stud and assembling frame.

Can and stud are in electrical contact with negative end termination. Can is covered by sleeve, designed to prevent accidental short circuit during maintenances or assembling operation. Air gap between capacitors and machinery's electrical parts, active parts or machinery's frame has to be taken into consideration for good insulation as defined to many standards of machines



## GENERAL WARNING

Information and data contained in the section “Technical Information” must be considered as a completing part of each family type or capacitor.

Before using a **Kendeil** capacitor in any application, please read carefully the related specifications included in the catalogue.

An improper installation or not respecting parameters limits might cause damage to the components, their characteristics modification and a decrease of their reliability and useful life.

Products manufactured by **Kendeil** are made with maximum care, in order to result free of defects in design, materials and workmanship, according with adequate specifications and international standard requirements.

### DISCLAIMER

Cooperation between Customers and **Kendeil** is basically precious in order to solve problems or when a failure occurs. In case of complaint you might have, please forward the following information along with an immediate communication of the failure.

Only upon previous agreement with **Kendeil**, you could send a detailed description of failure, indicating operative condition and type of application, number of defective pieces, eventually expressed in percent on whole quantity used. It is mandatory to know the original batch of goods as printed on the capacitor sleeve or labeled on the box, also let us know the delivery date and others relevant data from the billing documents. Samples of defective products should be sent to Kendeil for analysis, packed in order to prevent additional damages different from the ones detected.

Data sheets specifications are referred to a fairly large number of components and do not constitute a guarantee of characteristics or properties in the legal sense.

However, agreement on these specifications does not mean that the Customer may not claim for replacement of individual defective capacitors within the terms of delivery; **Kendeil** will not assume any further liability beyond the replacement of defective capacitors. This applies in particular to any further consequences of component failure as better specified further in this section.

A single failure among a delivered batch of capacitors should not be meaningful of poor reliability of the whole production batch, but should be understood to have reached incidentally the end of life within the failure rate defined for each series type.

### NO LIABILITY FOR CONSEQUENTIAL DAMAGES

**Kendeil** liability shall be limited to only replacement or repairing of goods, free of charge, after acknowledgement of received notification by customer.

**Kendeil** is not responsible for any possible damage to persons or things, of any kind, derived from improper installation, use of application of its products.

Also, the producer shall not be liable for any defect due to accident, fair wear and tear, negligent use, tampering, improper handling and shipment, operation and storage or any other default on the parts of any person other than Kendeil srl.

In customer applications requiring a very high level of operational safety and especially in customer applications in which the malfunction or failure of a passive electronic component could endanger human life or health (e.g. in accident prevention of life-saving systems), it must therefore be ensured by means of suitable design of the customer application or other action taken by the customer (e.g. installation of protective circuitry or redundancy) that no injury or damage is sustained by third parties in the event of malfunction or failure of a passive electronic component.

Any warnings, cautions and product specific notes must be observed.

To the maximum extent permitted by above statements, in no event shall Kendeil or its referred dealers be liable for any damages whatsoever (including without limitation, special, incidental, consequential, or indirect damages for personal injury, loss of business profits, business interruption or any pecuniary loss) arising out of the use or inability to use Kendeil products.

In the case of any product liability claim from third parties against **Kendeil srl**, not falling within Kendeil liability, Customer or Buyer should hold Kendeil harmless.

### COPYRIGHT INFORMATION

Copying of text and images in whole or in part of this catalogue is forbidden without previous written authorization of **Kendeil srl**. Anyhow brief sentences and abstracts are allowed free for technical articles on specialized publications.

## Kendeil GLOBAL DEALER

State	Address	Contacts	e-mail/web site
USA	Richardson RFPD	Tel +630-262-6800 toll-free phone 800-737-6937	rfpdsales@richardsonrfpd.com

## DISTRIBUTORS EUROPE

State	Address	Contacts	e-mail/web site
SWITZERLAND	<b>AMELEC ELECTRONIC GmbH</b> Brunnwiesenstrasse 6A CH 8157 Postfach Dielsdorf	Tel +41-44-8620062 Fax +41-44-8620063	info@amelec.ch www.amelec.ch
	<b>ELEKTRON AG</b> Riedhofstrasse 11 CH-8804 Au ZH	Tel +41-44-7810232 Fax +41-44-7810604	power@elektron.ch www.elektron.ch
GERMANY	<b>CEPTRONIC GmbH</b> Aresinger Str. 16 D-82299 Türkenfeld	Tel +49-8193-93-720-10 Fax +49-8193-93-720-60	michael.dohrmann@ceptronic.com www.ceptronic.com
UK	<b>ADEX TECHNICAL Ltd</b> Unit 7, Bittern House-Lakeside Business Park-South Cerney Cirencester-Gloucestershire GL7 5XL	Tel +44-1285-861640 Fax +44-1285-861646	sales@adexltd.co.uk www.adexltd.co.uk
SPAIN	<b>Almacenes Bilbainos de Electronica SL Albitron SL</b> c/o Julio Urquijo, 1Bis-48014 48014 Bilbao (Vizcaya)	Tel +34-94-4751006 Fax +34-94-4761958	albitron@albitron.es www.albitron.es
CZECH	<b>SEMIC TRADE s.r.o.</b> Volutova 2521/18 155 00 Praha 5	Tel +420-2-51625-331 Fax +420-2-51626-252	semic@semic.cz www.semic.cz
POLAND	<b>WEKTOR electronics</b> ul. Tarnogajska 11-13 50512 Wrocław	Tel +48 71/360-86-62 Fax +48 71/360-86-88	wektor@wektor-electronics.pl www.wektor-electronics.pl
SWEDEN	<b>CARBEX Ab</b> Kvarnbacksvagen, 12 592 41 Vadstena	Tel +46-143-29440 Fax +46-143-13580	info@carbex.se www.carbex.se
FRANCE	<b>A.E. SERVICE</b> Parc d'Activité du Cret de Mars 42150 La Ricamarie	Tel +33-477412147 Fax +33-477258029	a.e.service@wanadoo.fr www.aeservice.fr
ESTONIA	<b>ELEKTRO NORDIC OU</b> Mustramuäe tee 5-811, 10616 Tallinn	Tel +372-522 17 29 Fax +372-633 56 07	info@elektronordic.eu www.elektronordic.eu

<b>GREECE</b>	<b>MAR electronics L.T.D</b> 10, Salaminos Str. 54625 Thessaloniki	Tel +30-2310 532658 Fax +30-2310 532557	dimitris@marelectronics.gr www.marelectronics.gr
<b>NETHERLANDS</b>	<b>SAFARRA BV</b> Witte Paal 332k Schagen, Noord-Holland 1742 LE	Tel +31-224 217639 Fax +31-224 217765	info@safarra.nl www.safarra.nl
<b>ROMANIA</b>	<b>SYSCOM 18 SRL</b> Calea Plevnei 139B, 060011 Bucuresti 6	Tel +40-21 3102678 Fax +40-21 3169176	george.barbalata@syscom18.com www.syscom.ro
<b>TURKEY</b>	<b>Ozdisan Elektronik Pazarlama San Ve Tic A.S.</b> Des Sanayi Sitesi 104 Sok A07 Blok N°2 34776 Y. Dudullu Istanbul	Tel +90-21 64201882 Fax +90-21 64663686	info@ozdisan.com www.ozdisan.com
<b>UKRAINE</b>	<b>VD MAIS SCIENTIFIC AND PRODUCTION FIRM</b> M. Dontsia Str. 6 03061 Kyiv	Tel +38044/2200101 Tel +38044/4928852 Fax +38044/2200202	s.bondar@vdmals.kiev.ua www.vdmals.kiev.ua
<b>RUSSIA</b>	<b>TC PROFENERGY LLC</b> Stahanovskaya street, 22 build. 2 109428 Moscow	Tel +7-499-784-45-74 Fax +7-495-739-73-28	e.vasilieva@profenergy.ru www.profenergy.ru
	<b>MT-SYSTEM LTD</b> 13, Kalinina str. St. Petersburg, 198099	Tel +7-812-325-36-85 Fax +7-812-786-85-79	micro@mtgroup.ru www.mt-system.ru
	<b>SYMMETRON Co.</b> 195196, P.O.Box 49, Tallinskaya str., 7 St. Petersburg	Tel +7-812-449-4000 Fax +7-812-449-4704	spb@symmetron.ru www.symmetron.ru
	<b>SYMMETRON Co.</b> 125315, Leningradskiy pr., 68 - Moscow	Tel +7-495-797-5535 Fax +7-495-797-5545	moscow@symmetron.ru www.symmetron.ru

## DISTRIBUTORS ASIA

State	Address	Contacts	e-mail/web site
<b>INDIA</b>	<b>CRESTA INSTRUMENTS</b> 140, Sitladevi Temple Road 400 016 Mahim (West) Bombay	Tel +91-222 4464946 Fax +91-222 4457230	cresta@hathway.com www.crestainstruments.com
<b>IRAN</b>	<b>RAD ELECTRIC Co.</b> P.O. Box 11155-3358 NO,29, FERDOWSI ST. IMAM KHOMEINI SQ. Tehran	Tel +98-21-3391-0071 Fax +98-21-3397-3805	info@radelc.com www.radelc.com
<b>KOREA</b>	<b>CYBER DISTY CO Ltd</b> #501,Block A, Woolim Lion's Valley Gasan-Dong A-501 GEUMCHEON-GU, SEOUL	Tel +82-2 2026 5611/2/7 Fax +82-2 2026 5629	webmaster@cyberdisty.com www.cyberdisty.com
<b>HONG KONG</b> <b>CHINA</b>	<b>SUFFICE INDUSTRIAL TECHNOLOGY LIMITED</b> Flat H, 7/F, World Tech Centre, 95 How Ming Street, Kwun Tong	Tel (852) 2343 7563 Fax (852) 2797 8115	mail@suffice.com.hk www.suffice-group.com
<b>TAIWAN</b>	<b>SUFFICE TAIWAN</b> 7F-2, N°18, Lane 123, Sec. 6, Minqan E. Rd., Neihu District, Tapei City 114,	Tel 886-2-2795 5330 Fax 886-2-2795 5333	mail@suffice.com.hk www.suffice-group.com
<b>MALAYSIA</b>	<b>IMAX TECH ELECTRONICS Sdn Bhd</b> 15-02-27 Bayan Point, Medan Kampung Relau, 11900 Bayan Lepas, Penang	Tel +604-645 6080 Fax +604-645 5312	marketing@imax-tech.com www.imax-tech.com
	<b>IMAX TECH ELECTRONICS Sdn Bhd</b> 12-2A, Jalan PJU 1/3A, Sunwaymas Commercial Centre 47301 Petaling Jaya, Selangor	Tel +603-7803 7721 Fax +603-7803 7207	marketing@imax-tech.com www.imax-tech.com
<b>ISRAEL</b>	<b>COMODEX Investment &amp; Trade Co., LTD</b> 12 Gutman St 69343 Tel Aviv	Tel +972-3-6419871 Fax +972-3-6420185	info@comodex.net www.comodex.net
	<b>RAM N.S Technologies LTD</b> 1 Hamasger St P.O. Box #4383, Ind Zone Raanaana 43652, Israel	Tel +972-0-77 920 8111 Fax +972-0-77 920 8112	nati@ram-tech.co.il www.ram-tech.co.il
<b>BRUNEI</b> <b>INDONESIA</b> <b>PHILIPPINES</b> <b>SINGAPORE</b> <b>VIETNAM</b>	<b>Aflex Wheeltronics Pte Ltd</b> 7 Gambas Crescent, #05-25 ARK@Gambas Singapore 757087	Tel +65-6397-5218 Fax +65-6397-5217	sales@aflexwn.com www.aflexwn.com
<b>U.A.E.</b>	<b>IRONIX ELECTRONICS L.L.C.</b> Al Mereikhi Tower , #106, Sheikh Zayed Rd. P.O.Box : 85326 Dubai	Tel +971-4-3439951 Fax +971-4-3439953	niusha@ironix.com www.ironix.com
<b>THAILAND</b>	<b>IMAX TECHNOLOGIES COMPANY LIMITED</b> 88 Soi Lasalle 58, A.P, Nakarintr Building Floor No. 18, Unit No 9, Srinakarin Road Bangna Bangkok 10260	Tel +662-748-7478 Fax +662-748-7479	marketing@imax-tech.com www.imax-tech.com

## DISTRIBUTOR AUSTRALIA

State	Address	Contacts	e-mail/web site
AUSTRALIA	<b>SEMIKRON Pty Ltd</b> Unit 8/8 Garden Road 3168 Clayton, Victoria	Tel +61-3-85615600 Fax +61-3-95618769	sales.skau@semikron.com www.semikron.com.au

## DISTRIBUTORS AFRICA

State	Address	Contacts	e-mail/web site
SOUTH AFRICA	<b>COMMUNICA (Pty) Ltd.,</b> 53 Landmarks Avenue Samrand The Reeds 0157- CENTURION	Tel +27-12-6573511 Fax +27-12-6573550	info@communica.co.za www.communica.co.za
EGYPT	<b>ALAG TRADING</b> 3, Amiralay Hussein Gad Str. Heliopolis Gharb, Cairo	Tel +202 26350667 Fax +202 26330541	info@alagtrading.com www.alagtradingonline.com

## DISTRIBUTORS NORTH AMERICA

State	Address	Contacts	e-mail/web site
USA	<b>I.C.T. Power USA Inc.</b> 3960 Commerce Drive Saint Charles, Illinois 60174 USA	Phone 630-457-1104 Toll Free 888-428-8600	sales@ictpowerusa.com www.ictpowerusa.com
CANADA	<b>I.C.T. Power USA Inc.</b> 1220 Corporate Drive Burlington, On Canada L7L 5R6	Phone 905.631.8494 Fax 905.631.8495 Toll Free 1.888.428.1220	sales@ictpower.com www.ictpower.com

## SALES REPRESENTATIVES

State	Address	Contacts	e-mail/web site
GERMANY	<b>Gerhard Pahlke</b> Aichacherstrasse 6 85302 Gerolsbach	Tel +49 8445 9299 755 Fax +49 322 2243 6912	kendeil@gerhard-pahlke.de www.kendeil.com
USA	<b>I.C.T. Power USA Inc.</b> 3960 Commerce Drive Saint Charles, Illinois 60174	Phone +630-457-1104 Toll Free 888-428-8600	sales@ictpowerusa.com www.ictpowerusa.com
	<b>JUDGE COMPONENT SOLUTIONS</b> 156 Sandy Brook Road North Scituate, RI 02857	Tel +401-227-4600 Mobile +401-374-9710	judgecs@verizon.net

## SALES OFFICES

State	Address	Contacts	e-mail/web site
FINLAND	<b>Markku Kaipainen</b> Huvilarinne, 9 FI-10160 Degerby	Tel +358 40 7025160 Fax +39 0331 786967	m.kaipainen@kendeil.com www.kendeil.com
ITALY	<b>Kendeil Direct sales</b> Via Irlanda, 1 21013 Gallarate (VA)	Tel +39 0331 786966 Fax +39 0331 786967	kendeil@kendeil.com www.kendeil.com















**Kendeil™**

## Aluminium Electrolytic Capacitors

**Kendeil S.r.l.**

Via Irlanda, 1

I-21013 GALLARATE (VA)

Tel. +39-0331 786966

Fax +39-0331 786967

e.mail: [kendeil@kendeil.com](mailto:kendeil@kendeil.com)

website: [www.kendeil.com](http://www.kendeil.com)

ALL PRODUCTS READY

RoHS Compliant



AGENT OR DISTRIBUTOR