

AMO 5G Smart Phone

5G Mobile AiP(Antenna in Package)

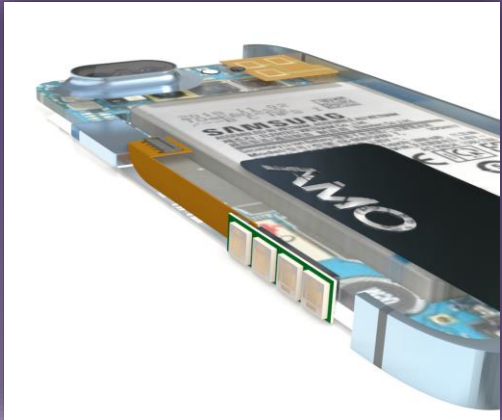
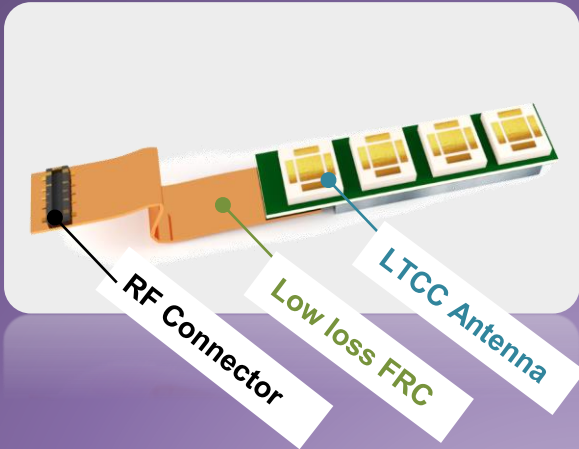

- Low Temperature Cofired Ceramics
- Flexible RF Cable

5G FRC(Flexible RF Cable)

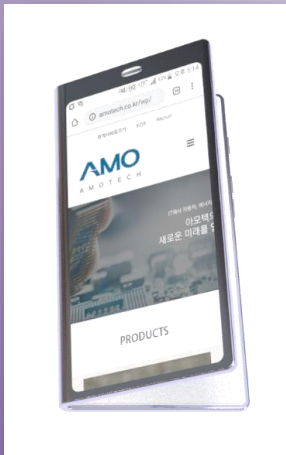
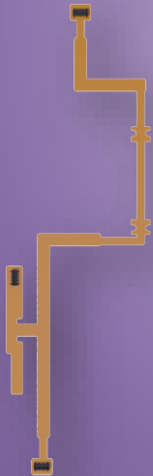

Multi-Signal Transmission Line



PTFE or LCP

5G Component

5G 28GHz BPF & Divider



60GHz BPF



AMO 5G Solution

5G AiP(Antenna in Package)

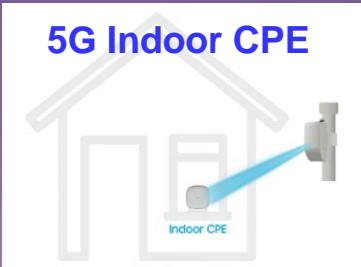
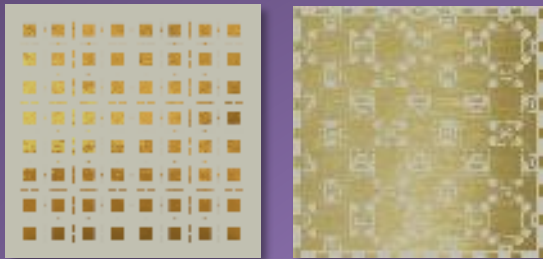

5G Thermal Solution

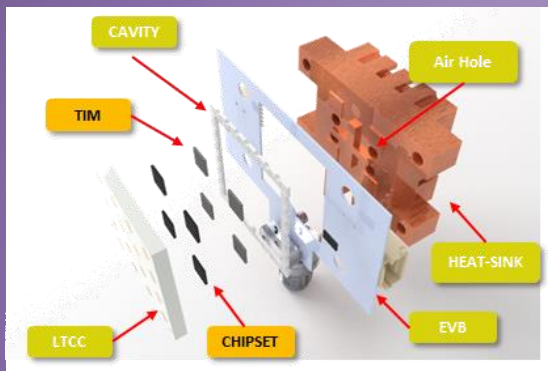

Low DK Thermal Sheet

TIM(Thermal Interface Material) & Liquid

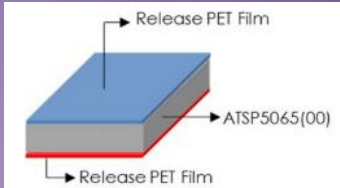
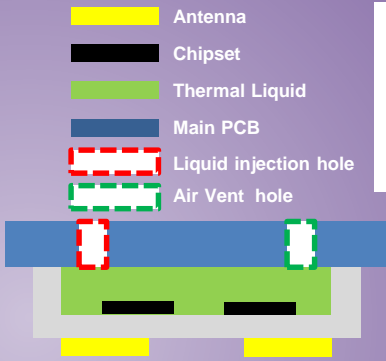

5G Component



GAN Power Amplifier

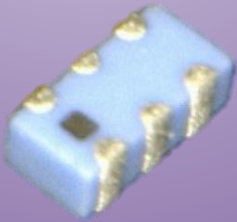

5G Sub-6GHz BPF

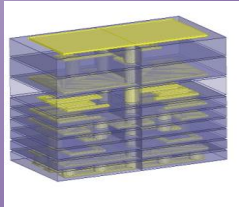

5G Automotive

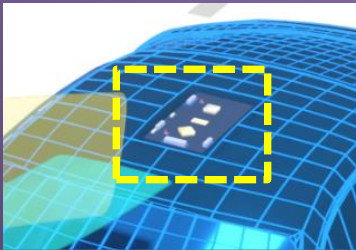

5G Smart Antenna

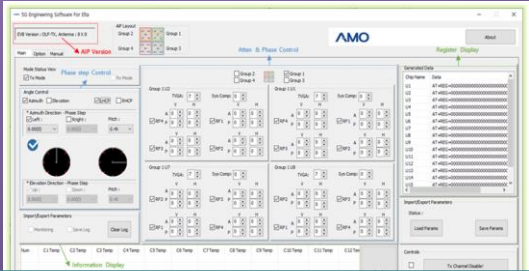

5G Automatic PC Test Program

AMO RADAR

Waveguide RADAR Antenna

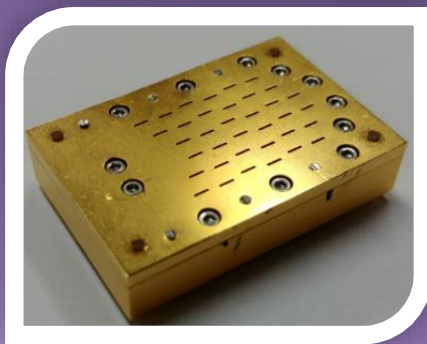

Plastic + Plating Antenna

High-End 3D Image RADAR Antenna

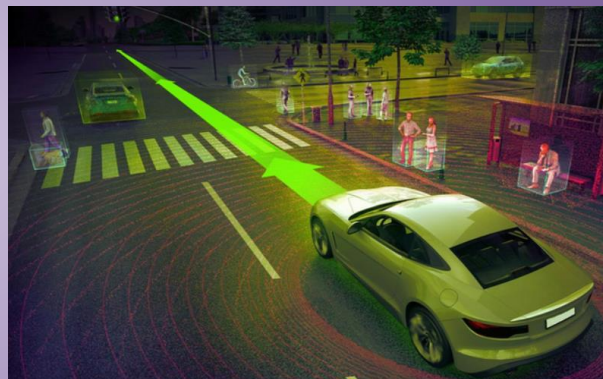
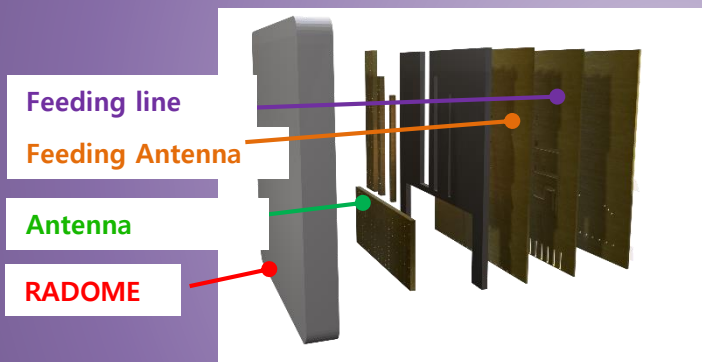

LiP (Launcher-in-Package) RADAR

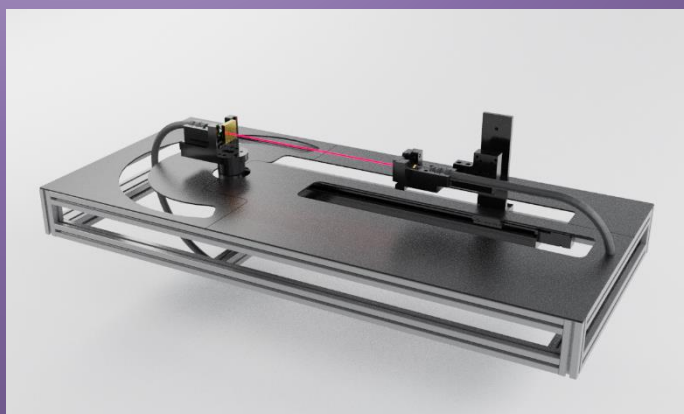
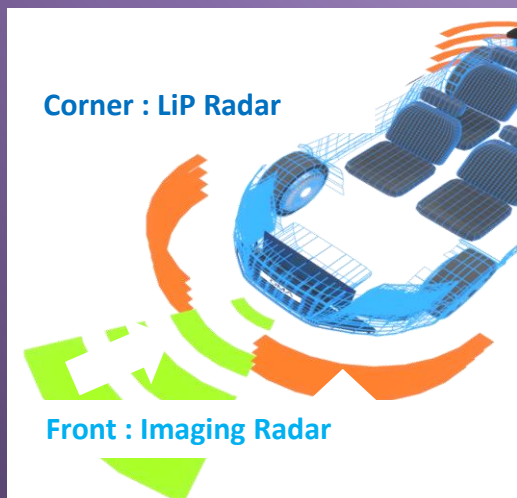

Automatic Test Environment