



WMA100A

100 MHz LOW NOISE PRE-AMPLIFIER

REV A
November 2018

Key Features



- Frequency of 100 MHz
- 1.5 Ohm Input Impedance
- 0.45 dB Noise Figure
- 30.0 dBm Max P_{IN}
- 22.0 dBm Output IP_3
- 28.0 dB Gain
- 10.0 dBm P_{1dB}
- 1.22:1 Output VSWR
- Unconditional Stable, $k > 1$
- Single Power Supply
- None Magnetic

Product Description

WMA100A is integrated with WanTcom proprietary low noise amplifier technologies, high frequency micro electronic assembly techniques, and high reliability designs to realize optimum low noise figure, wideband, and high performances together. With single +10.0V DC operation, the amplifier has 1.5 Ohm input impedance and unconditional stable condition. The amplifier has 0.60" x 0.40" x 0.10" surface mount package.

Other frequencies and impedance available!

CAUTION:



ELECTROSTATIC DISCHARGE

Applications

- Magnetic Resonance Imaging
- RF Measurement
- Medical
- Current Sensor



Specifications

Summary of the key electrical specifications at room temperature, tested in the WanTcom fixture, 80051.

Index	Testing Item	Symbol	Test Constraints	Min	Nom	Max	Unit
1	Gain	S_{21}	100 MHz	27.5	28.0	28.5	dB
2	Gain Variation	ΔG	100 +/- 0.5 MHz		+/-0.03	+/- 0.05	dB
3	Input Impedance	RE [Zin]	100 MHz	1.2	1.5	2.0	Ohm
		IM [Zin]	100 MHz	-3.0	0	3.0	Ohm
4	Output VSWR, 50 Ohm Impedance	SWR_2	100 MHz			1.22:1	Ratio
5	Reverse Isolation	S_{12}	100 MHz		60		dB
6	Noise Figure	NF	100 MHz		0.45	0.55	dB
7	Output Power 1dB Compression Point	P_{1dB}	100 MHz	7	10		dBm
8	Output-Third-Order Interception Point	IP_3	Two-Tone, $P_{out} = 0$ dBm each, 1 MHz separation	18	22		dBm
9	Current Consumption	I_{dd}	$V_{dd} = +10.0$ V		16		mA
10	Power Supply Operating Voltage	V_{dd}		+7	+10	+12	V
11	Thermal Resistance	$R_{th,c}$	Junction to case			220	$^{\circ}C/W$
12	Operating Temperature	T_o		+10		+60	$^{\circ}C$
13	Maximum RF Input Power	$P_{IN,MAX}$	DC – 6.0 GHz, 10% Duty Cycle,			30	dBm
14	Saturate Recover Time	t_{sr}	10% to 90% from 30 dBm Pin		8	10	μS
15	ESD Protection, None Contact	V_{ESDN}	Output Port			16	kV
16	ESD Protection, Direct Contact	V_{ESD}	Output Port			6	kV

Absolute Maximum Ratings

Parameters	Units	Ratings
DC Power Supply Voltage	V	15.0
Drain Current	mA	30
Total Power Dissipation	mW	350
RF Input Power, 10% Duty Cycle	dBm	30
Junction Temperature	$^{\circ}C$	150
Storage Temperature	$^{\circ}C$	-65 ~ 150
Operating Temperature	$^{\circ}C$	0 ~ +70
Thermal Resistance ¹	$^{\circ}C/W$	215

Operation of this device beyond any one of these parameters may cause permanent damage.

Ordering Information

Model Number	WMA100A
--------------	---------

¹ The last stage transistor dominates the heat dissipation. The drain bias voltage is +6V and the drain current is 15.0 mA. The total power dissipation of the last stage transistor is thus 90 mW. The junction temperature arise $0.09 \times 215 = 19$ ($^{\circ}C$).

Specifications and information are subject to change without notice.

Functional Block Diagram

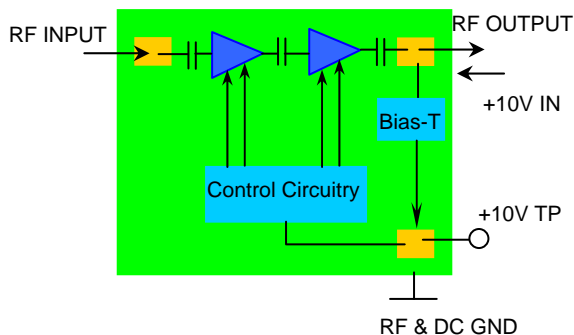



ESD Tray is used for the packing. Contact factory for tape and reel packing option for higher volume order.

Typical Data

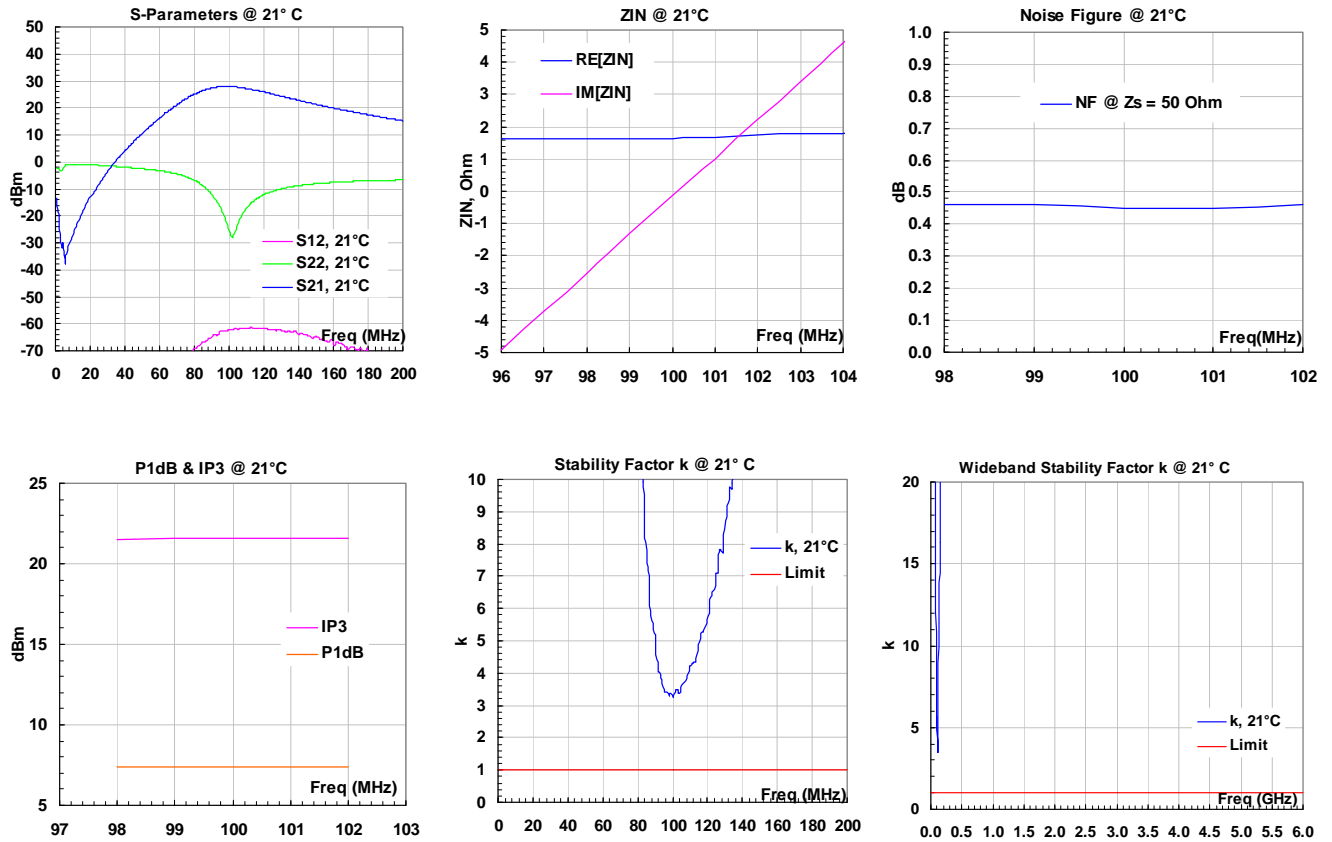

Outline,

PIN	1	2	3	4	CNTR
FCTN	IN	NC/10V	OUT/10V	GND	GND

UNITS: INCH [mm]
FINISH: WHITE TIN

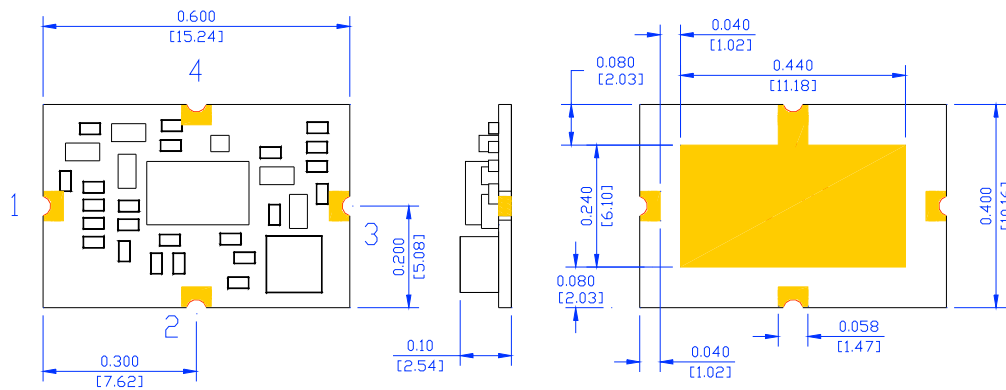

Specifications and information are subject to change without notice.



Foot Print/Mounting Layout:

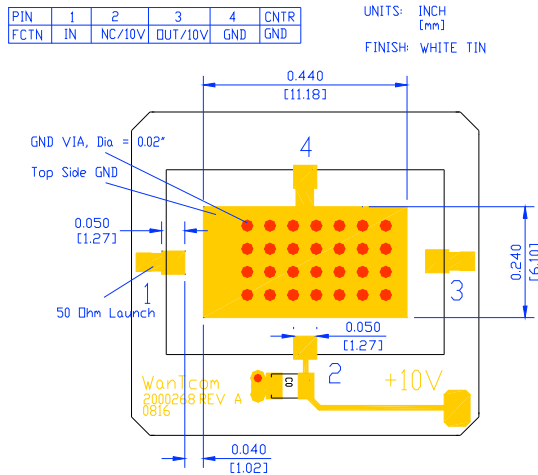

Application Notes:

A. Motherboard Layout

The recommended motherboard layout is shown in diagram of **Foot Print/Mounting Layout**. Sufficient numbers of ground vias on center ground pad are essential for the RF grounding. The width of the 50-Ohm microstrip lines at the input and output RF ports may be different for different property of the substrate. The ground plane on the backside of the substrate is needed to connect the center ground pad through the vias. The ground plane is also essential for the 50-Ohm microstrip line launches at the input and output ports.

The +10V DC voltage is applied at Pin 2 or at the output Pin 3. There is a built-in bias-T at the output port to separate the RF output signal and input +10V DC power supply.

No DC block capacitor is required at input RF ports.

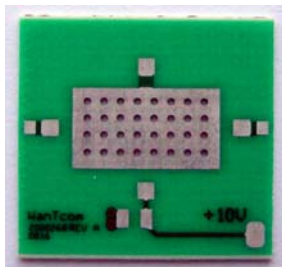

Fig. 1 Example of the motherboard

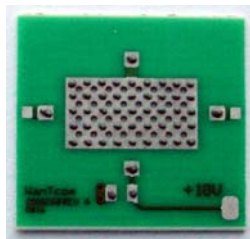

Fig. 2 Dispensed solder paste

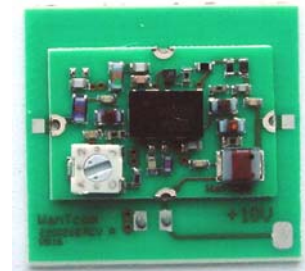

Fig. 3 Assembled part

B. Assembly

The regular low temperature and none clean solder paste such as SN63 is recommended. The high temperature solder has been used internally for the WHM series amplifier assembly. The melting temperature point of the high temperature solder is around 217 ~ 220 °C. Thus, melting temperature of the solder paste should be below 217 °C for assembling WHM series amplifier on the test board to reduce the possible damage. The temperature melting point of the SN63 solder paste is around 183 °C and is suitable for the assembly purpose.

The SN63 solder paste can be dispensed by a needle manually or driven by a compressed air. **Figure 2** shows the example of the dispensed solder paste pattern. Each solder paste dot is in the diameter of 0.005" ~ 0.010" (0.125 ~ 0.250 mm).

For volume assembly, a stencil with 0.006" (0.15 mm) is recommended to print the solder paste on the circuit board.

For more detail assembly process, refer to AN-109 at www.wantcominc.com website.

Specifications and information are subject to change without notice.